



Shipping & Mailing  
Franking Machines

# SendPro® C, SendPro®+

## User Guide

UK English Edition  
SV63242-gb Rev.F  
09 September 2022

©2022 Pitney Bowes Inc.

All rights reserved. This book may not be reproduced in whole or in part in any fashion or stored in a retrieval system of any type or transmitted by any means, electronically or mechanically, without the express written permission of Pitney Bowes.

The use of this information by the recipient or others for purposes other than the training of customers on Pitney Bowes equipment may constitute an infringement of intellectual property rights of Pitney Bowes, and Pitney Bowes assumes no responsibility for any such use of the information.

We have made every reasonable effort to ensure the accuracy and usefulness of this manual. However, we cannot assume responsibility for errors or omissions or liability for the misuse or misapplication of our products.

Except as provided in writing, duly signed by an officer of Pitney Bowes, no license either express or implied, under any Pitney Bowes or third party's patent, copyright or other intellectual property rights is granted by providing this information.

PB Postage™ is a trademark of Pitney Bowes Inc.

# Table of Contents

## 1 - Installation

---

Installing the SendPro C, SendPro+ .....	9
Installing a scale .....	17
Installing an external scale .....	18
Installing the printhead .....	21

## 2 - Connectivity

---

Setting up a wired network connection .....	27
Setting up a wireless (Wi-Fi) network connection .....	29
Connecting to a hidden Wi-Fi network .....	30
Forgetting a Wi-Fi network .....	32
Checking your network connection .....	34
Finding the MAC address for wired and wireless networks .....	34
Setting up a Proxy server .....	38

## 3 - Scales and Weighing

---

Using the scale when printing postage .....	42
Entering the weight manually when printing postage .....	42
Zeroing the scale .....	43

## 4 - Accounting

---

What is Accounting .....	46
Adding an account .....	47
Turning Envelope Printing account passwords on or off .....	48
Selecting an Envelope Printing account .....	50

---

Editing an account .....	50
Making an account inactive .....	51
Deleting an Envelope Printing account .....	52

## 5 - Postage Funding

---

Checking the available funds for printing postage .....	54
Refilling postage funds for printing postage .....	55
Getting a Royal Mail refund for damaged or incorrectly printed mail .....	56
Changing the default refill amount for printing postage .....	57
Setting the low funds warning for printing postage .....	58

## 6 - Mailing and Shipping

---

Signing in to and out of the Parcel Shipping app .....	60
Printing a shipping label .....	60
Printing a shipping label from the Address Book .....	67
Tracking a shipment .....	67
Adding a new sender address for shipping labels .....	67
Editing the sender address for shipping labels .....	67
Reprinting a shipping label .....	68
Getting a refund for a shipping label .....	68
What are shipping Cost Accounts? .....	68
Turning cost accounts on or off for shipping labels .....	69
Adding a shipping label cost account .....	69
Modifying a shipping labels cost account .....	70
Adding a shipping labels preset .....	71
Setting a transaction limit for shipping labels .....	72
Setting the label options for shipping labels .....	72
Emailing tracking numbers for shipping labels .....	72
Use SendPro Online to perform these tasks .....	73
Sending post by First Class .....	74
Sending a large First Class envelope .....	74
Sending an international letter .....	74
Sending post using Special Delivery rates .....	75
Sending post using Signed For rates .....	81
Viewing and exporting Special Delivery and Signed For tracking numbers in Inview .....	86



## 7 - Address Management

---

Using the Address Book .....	91
Adding new addresses to the Address Book .....	91
Searching addresses in the Address Book .....	91
Editing addresses in the Address Book .....	91
Deleting addresses from the Address Book .....	92

## 8 - Sealing

---

Filling the moistener tank .....	95
Sealing envelopes when you print postage .....	95
Sealing envelopes without printing postage .....	97
Avoiding envelope sealing issues .....	98

## 9 - History and Reports

---

Viewing a postage refill receipt for Envelope Printing .....	101
Viewing the total spent on printing postage .....	101
Printing a funds report .....	101
Running postage printing account reports .....	102
Setting the postage printing account report period .....	103
Setting the account report preferences .....	104
Emailing an account report .....	105

## 10 - Printing

---

What are print modes .....	108
Printing a custom or standard graphic .....	108
Adding a custom text message .....	111
Printing a graphic without printing postage .....	111
Printing only the date and time .....	112
Printing a test pattern .....	112

## 11 - Feeding and Jamming

---

Preventing envelope feeding problems .....	115
--	-----

## 12 - Ink

---

Checking the ink level .....	118
Ordering ink cartridges .....	118
Replacing the ink cartridge .....	119

## 13 - Settings

---

What are presets .....	122
Adding presets .....	122
Selecting a preset .....	124
Renaming a Preset .....	124
Setting the default preset reset timer .....	126
Deleting a Preset .....	126
Advancing the date .....	127
Adjusting display brightness .....	127
Using the Toolbar .....	128
Adjusting the scale location code .....	129
Clearing or resetting the number of mailpieces sent .....	130
Creating or disabling the security PIN .....	130
Uploading postage transactions .....	131
Uploading system logs .....	132

## 14 - Rate Change

---

Updating postal rates or software .....	135
---	-----

## 15 - Maintenance

---

Cleaning the printhead .....	138
Cleaning the moistener brush and wick assembly .....	141
Ordering supplies .....	146

## 16 - Product Information

---

Finding the Product Code Number (PCN) and serial number .....	148
Navigating the Home screen .....	149

Navigating the Envelope Printing app .....	149
Connections on the back .....	150
Royal Mail requirements .....	151
Parts of the SendPro C, SendPro+ .....	151
Parts of a postal frank .....	152
Postal Security Device .....	153
Specifications .....	153
Material specifications .....	156
Moving the SendPro C, SendPro+ .....	158
Important safety notes .....	158
Contacting Pitney Bowes .....	160
Third party software .....	161

# 1 - Installation

## In this section

Installing the SendPro C, SendPro+.....	9
Installing a scale.....	17
Installing an external scale.....	18
Installing the printhead.....	21

# Installing the SendPro C, SendPro+



Follow these instructions to install a SendPro C, SendPro+ for the very first time.

1. *Before you begin*
2. *Open the box*
3. *Unpack the device*
4. *Install the printhead*
5. *Install the ink cartridge*
6. *Connect device to a power source*
7. *Continue installation steps*

## 1 Before you begin

Before you begin installing your new SendPro C, SendPro+, you need to decide what type of connection (wired or wireless) you want to use.

Choose your connection type

<b>Wired Connections</b> 	Take about 10 minutes to set up Require an ethernet port and power outlet.
<b>Wireless Connections</b> 	Take about 15 minutes to set up Require access to a wireless network and power outlet.

## 2 Open the box

In the box you will find:

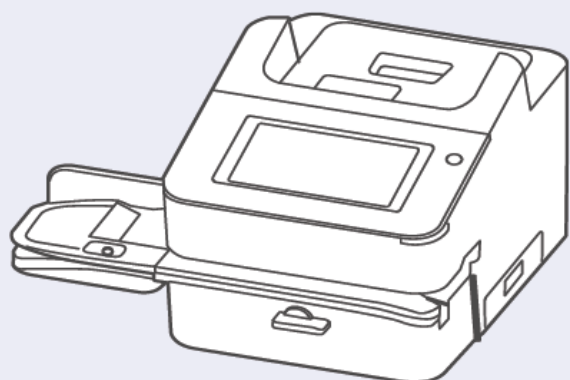

SendPro C

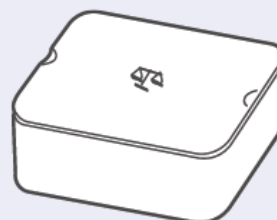
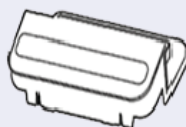

Cover or Scale

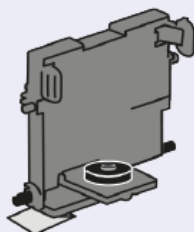

Printhead

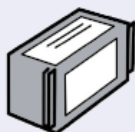

Ink Cartridge



E-Z Seal



LAN / Internet  
Cable



Power Cord



Tape Sheets

# 3

## Unpack the device

1. Remove the device and all items from the box.



2. **Important:** Be sure to grab hold of the entire feeder, not just the moistener flap when lifting the device out of the box.



3. **Do not** connect your device to a power source yet.

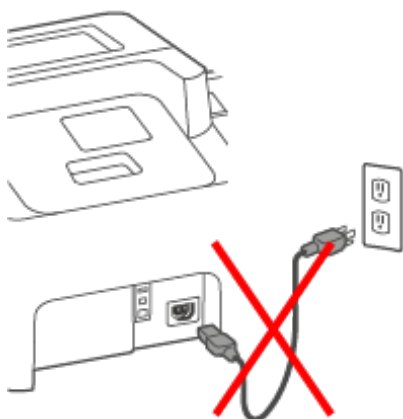

4. Remove all packing materials from the device.

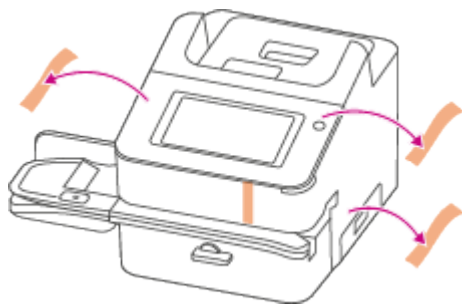

## 4 Install the printhead

1. Open the cover to access the ink carriage.

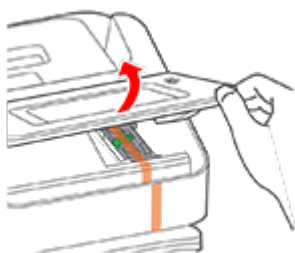

2. Remove the packing tape from the ink carriage.

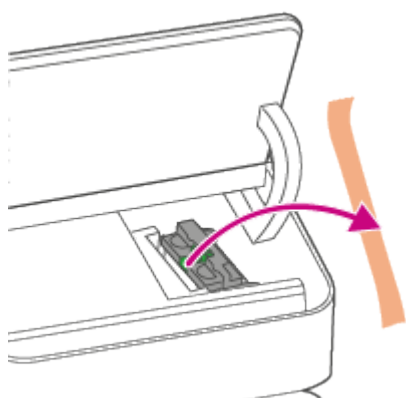



3. Open the ink carriage guard.

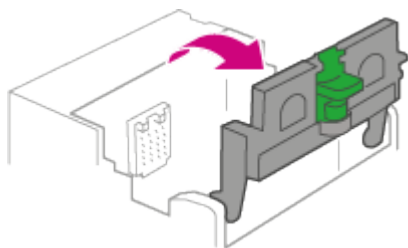

4. Unwrap the printhead and remove the protective strip.

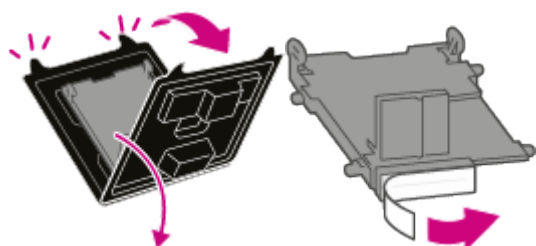

5. Squeeze the tabs and slide the printhead pegs into the lower set of grooves.  
**Important:** This step is critical to prevent device damage.

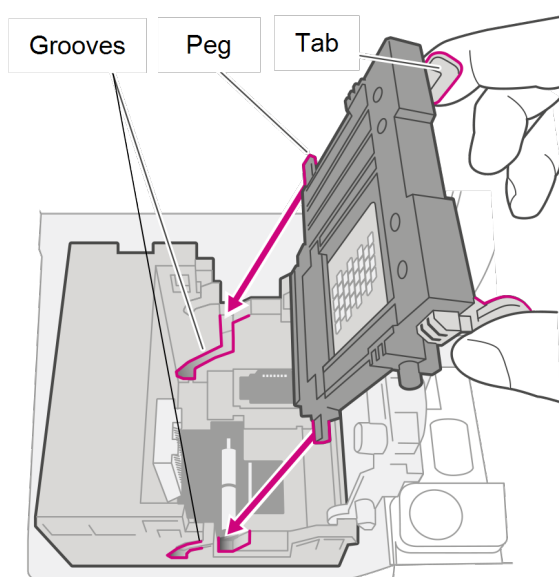

6. Keep squeezing the tabs and push the printhead flush against the wall. The tabs snap outward when you place the printhead correctly.

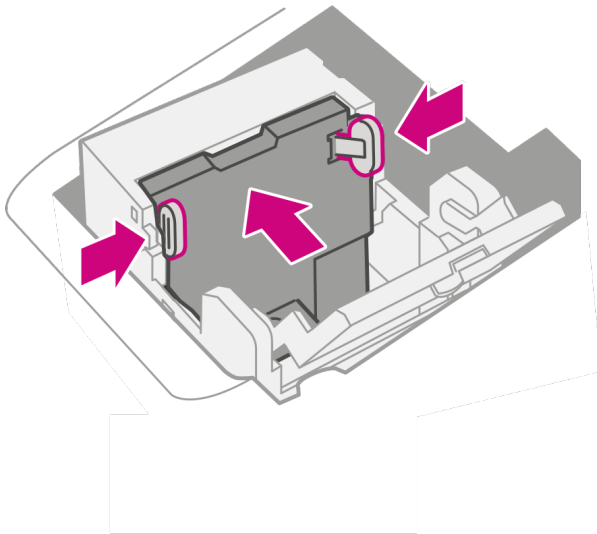

## 5 Install the ink cartridge

1. Unwrap the ink cartridge and remove the silver foil strip from the ink cartridge.

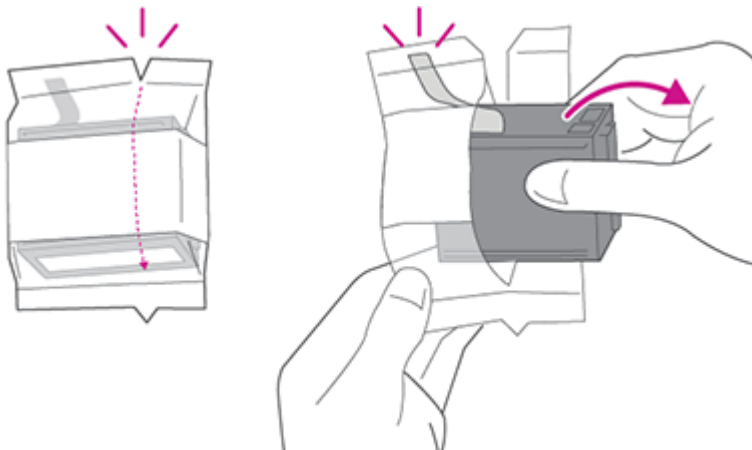

2. Install the ink cartridge and close the guard.

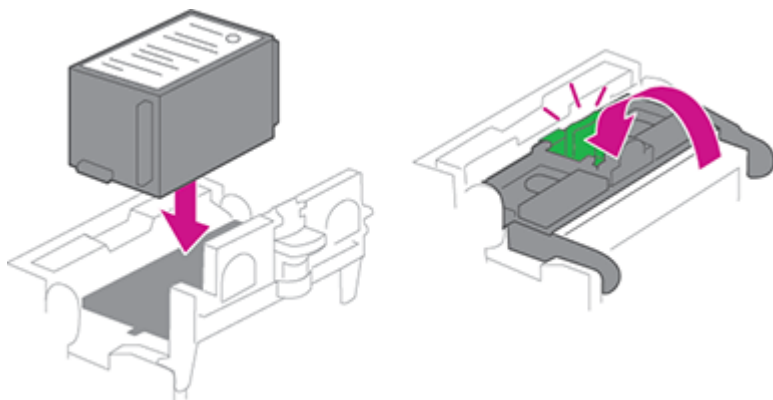

3. Close the cover.

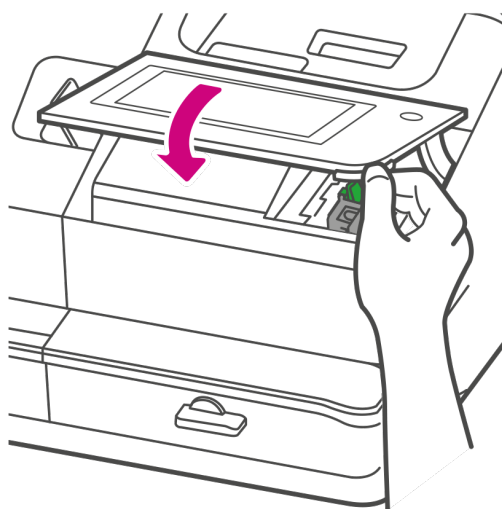

## 6 Connect the device to a power source

Connect the device to a power source. Tap the power button.

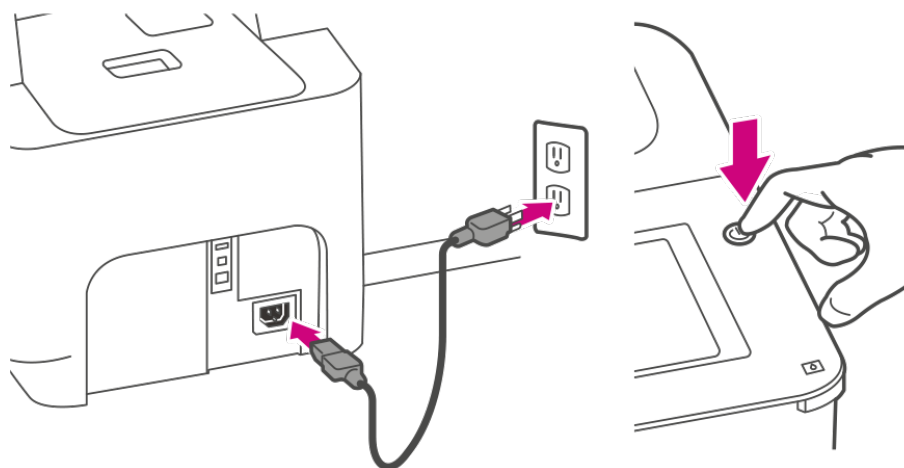

## 7 Follow the installation instructions on the device

1. Wait for the device to start up.
2. Tap **Get Started** on the touchscreen and continue the installation steps on the screen.



3. Tap **Got it** when you see the message "You're ready to start sending."

## Installing a scale

Install a scale if you did not install one when you installed your device. Your device contains step-by-step installation instructions for compatible scales.

1. Tap **Settings**.



2. Scroll to the Advanced Device Options section at the bottom of the Settings screen, then tap **Scale Installation Guides**.

- To view all the available scales, swipe to the left on the screen.

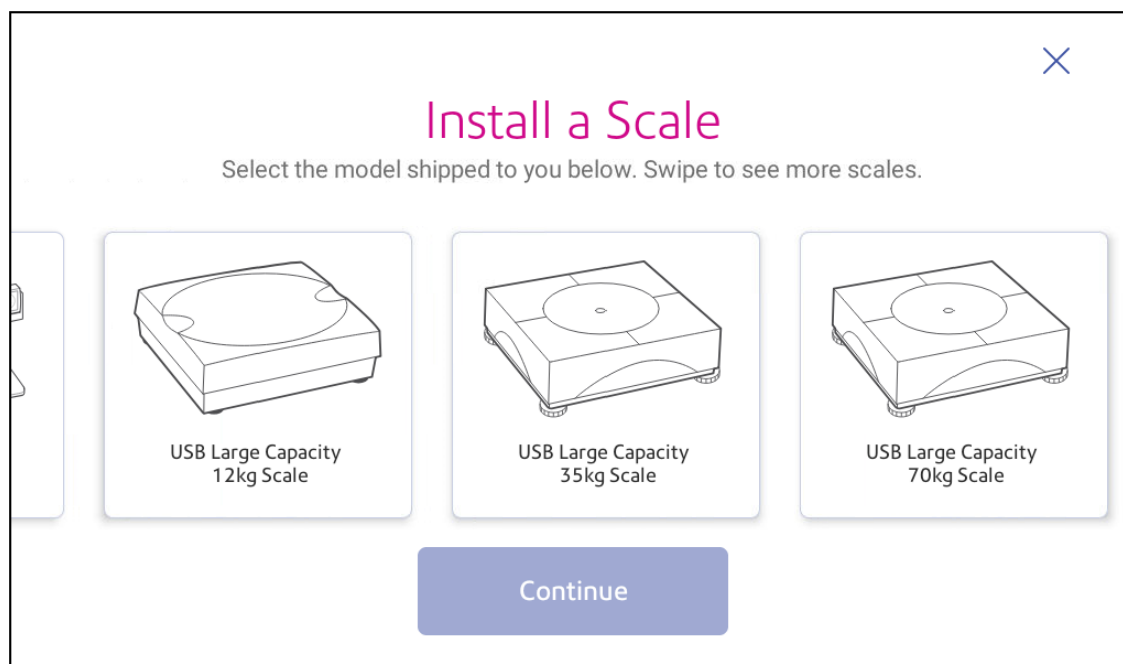

- Tap to select the appropriate scale, then tap **Continue**.
- Follow the instructions on the screen. To advance to the next step, swipe the screen to the left.

## Installing an external scale

Use an external scale if you send large packages or parcels. External scales have a larger weight capacity for heavier items.

1. If you are using the scale that is located on top of the device, remove the scale by lifting it off.



2. Fix the blanking plate on the device where the scale was located.



3. Tap **Settings**.



4. Scroll down and tap **Scale Installation Guides**.



- Swipe to the left and select the scale you are installing.

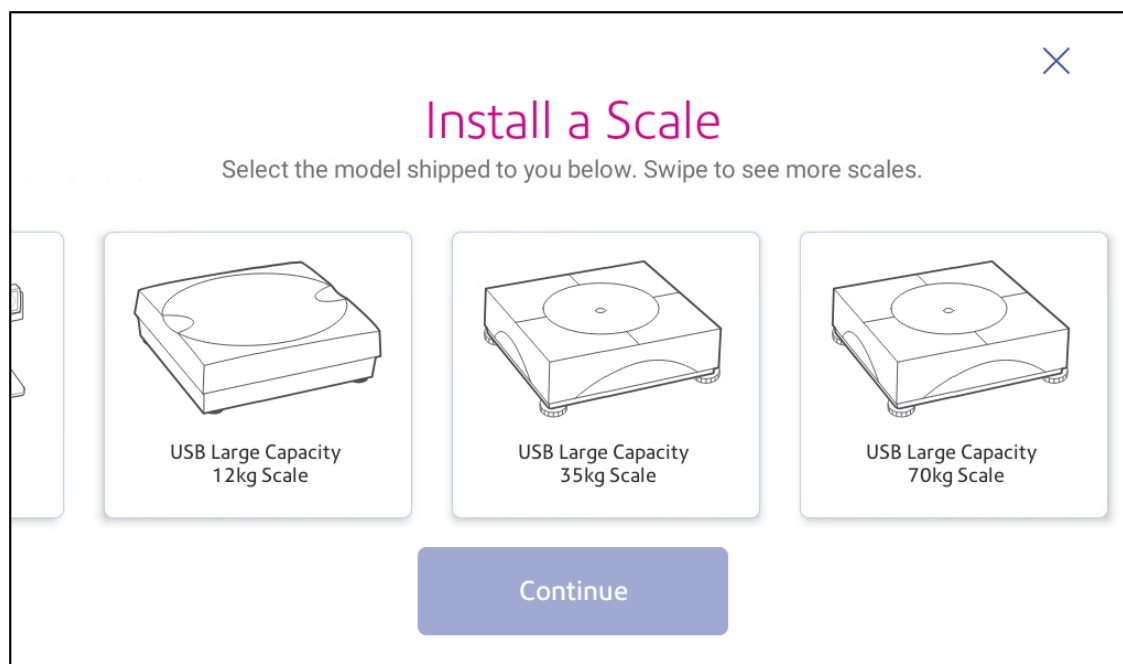

- Tap **Continue**.
- Following the on-screen instructions. Swipe to the left and unbox the scale.
- Position and level the scale. The scale has a level bubble under its lid. Ensure the bubble is within the circle of the level bubble by adjusting the round feet of the scale.
- Connect the large end of the USB cable into the device. Connect the other end into the scale.
- Tap **Continue**.
- Tap **Verify**.
- Tap **Got It**.
- Tap **Envelope Printing**.
- Tap **Weight**, then tap **Scale**.
- Place the mail on the scale.
- Tap **Apply**.

## Installing the printhead

You may need to install a new printhead when the existing printhead is producing poor print quality.

- Tap **Settings**.



2. Scroll down and tap **Envelope Printer Maintenance**.
3. Tap **Install Printhead**.
4. Lift the cover. The ink cartridge moves to the front position.
5. Flip the ink cartridge cover open.

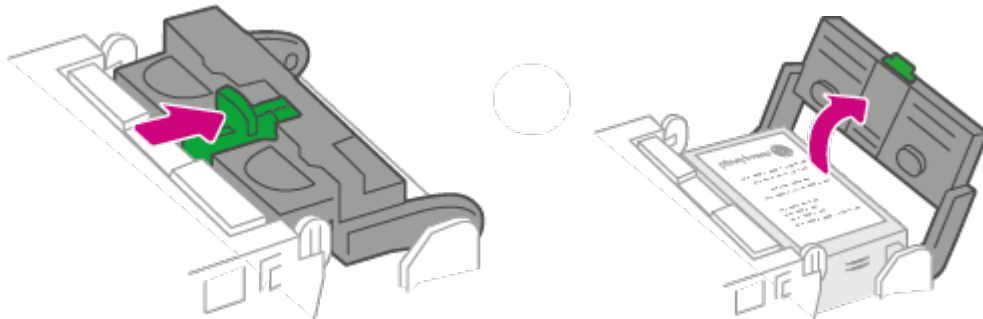

6. Remove the ink cartridge.

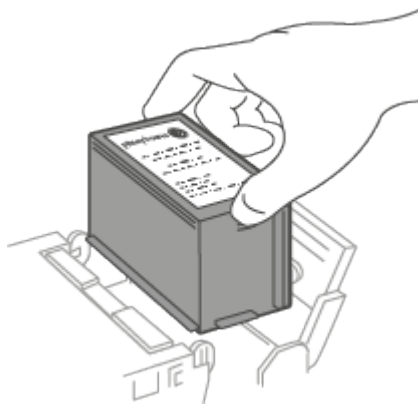

7. Squeeze the two gray tabs on either side of the printhead.

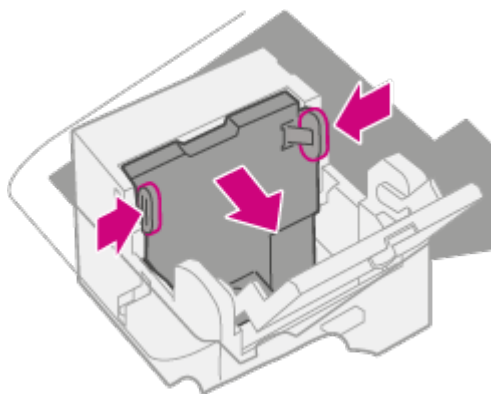

8. While squeezing, lift and tilt the printhead to the right. The printhead should come up out of the device.

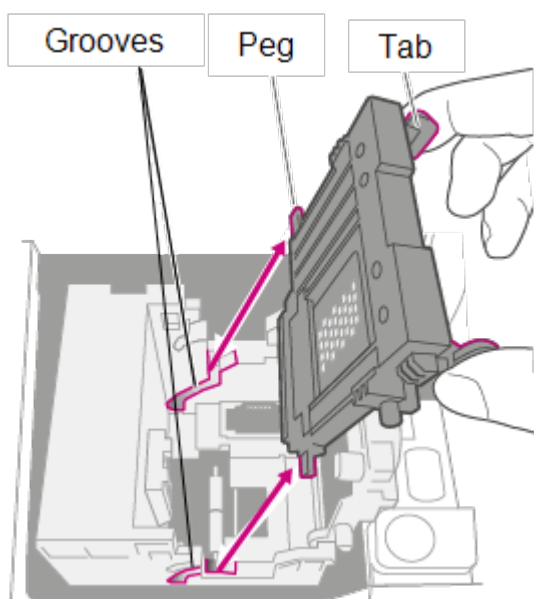

9. Unwrap the new printhead and remove the protective strip.

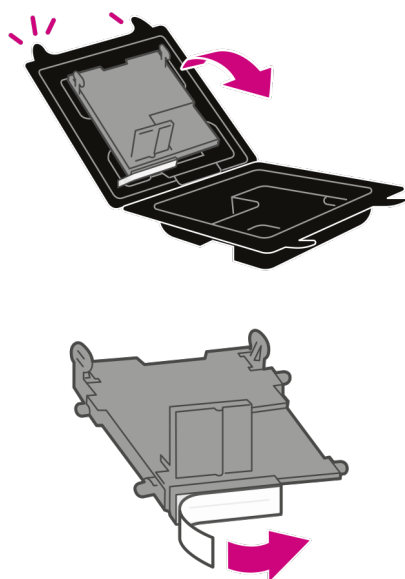

10. Squeeze the tabs and slide the printhead pegs into the lower set of grooves.

**Warning:** If you do not seat the printhead correctly it can damage the device.

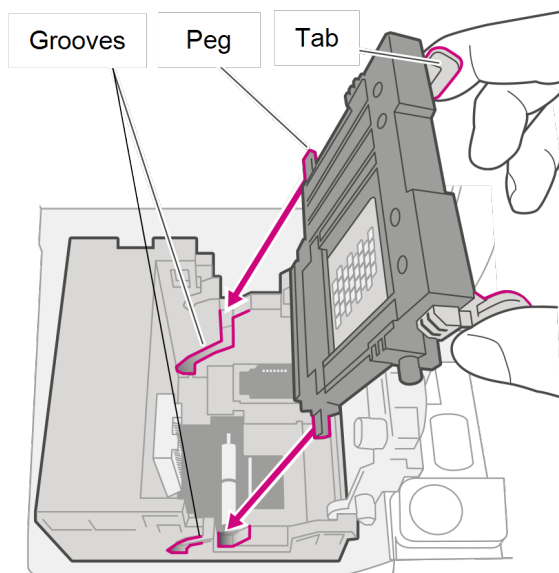

11. Keep squeezing the tabs and push the printhead flush against the wall. Tabs will snap outward when placed correctly.

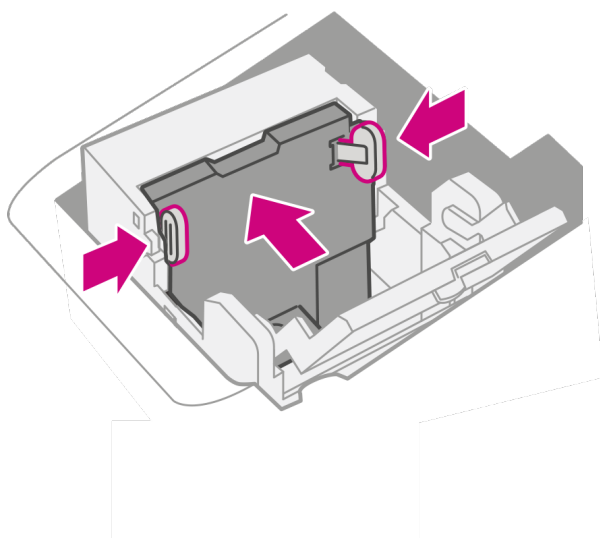

12. Install the ink cartridge and close the guard.

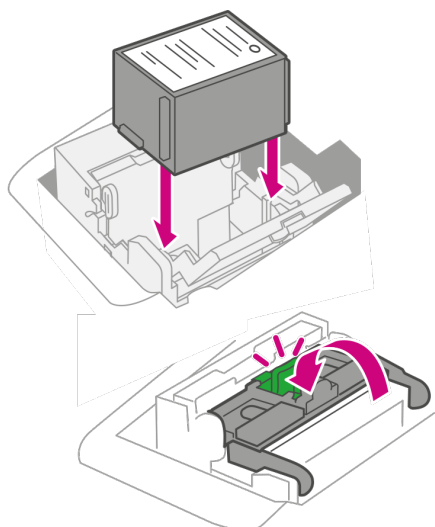

13. Close the cover. The ink cartridge moves back to the original position.

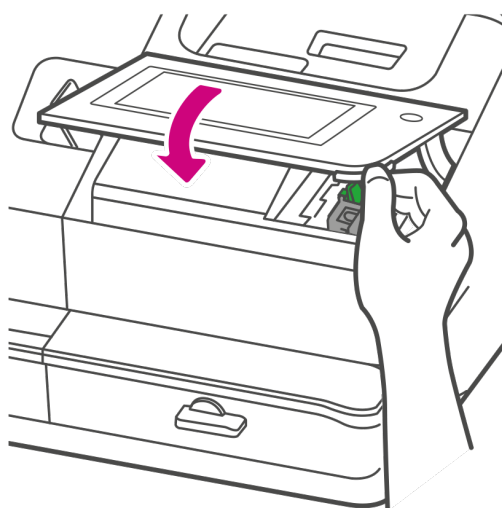

14. Tap **Done**.

15. Print a print test pattern to be sure that your printhead is working properly.

# 2 - Connectivity

## In this section

---

Setting up a wired network connection.....	27
Setting up a wireless (Wi-Fi) network connection.....	29
Connecting to a hidden Wi-Fi network.....	30
Forgetting a Wi-Fi network.....	32
Checking your network connection.....	34
Finding the MAC address for wired and wireless networks.....	34
Setting up a Proxy server.....	38

## Setting up a wired network connection

Use a network cable to connect your SendPro C, SendPro+ to the Pitney Bowes Data Center.

### Step 1: Plug in your network cable

Plug one end of your network cable to your device and the other end to an internet jack on the wall or a router.

### Step 2: Choose the connection type

Select one of the two connection types supported for this device:

- *DHCP*
- *Static IP*

DHCP is the most common connection type. Choose DHCP if you are unsure which connection protocol to use or contact your IT department for advice.

DHCP

1. Tap **Settings**.

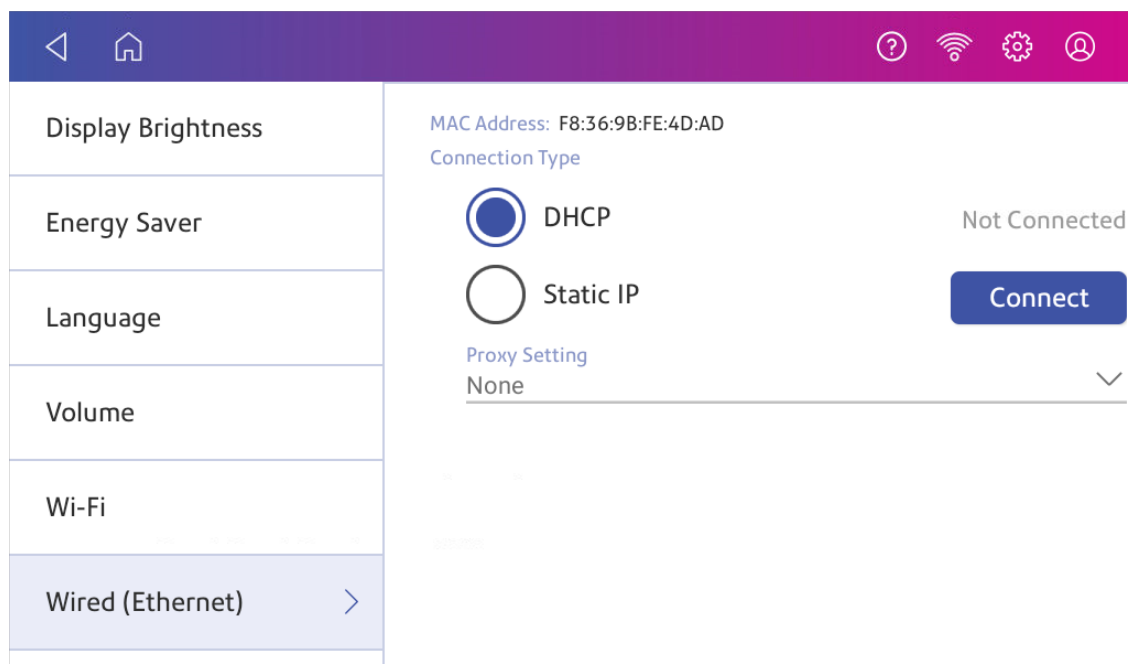

2. Tap **Wired**.

3. Select **DHCP**.4. Tap **Connect**.

5. If it does not connect, unplug the power cord.
6. Wait 30 seconds. The screen should turn off after 10 seconds.
7. Plug the power cord back in directly into a wall outlet.
8. Quickly tap and release the power button to turn the device back on.
9. Tap **Settings**.



10. Tap **Wired (Ethernet)**.
11. Tap **DHCP**.
12. Tap **Connect**.

## Static IP

1. Tap **Settings**.



2. Tap **Wired**.

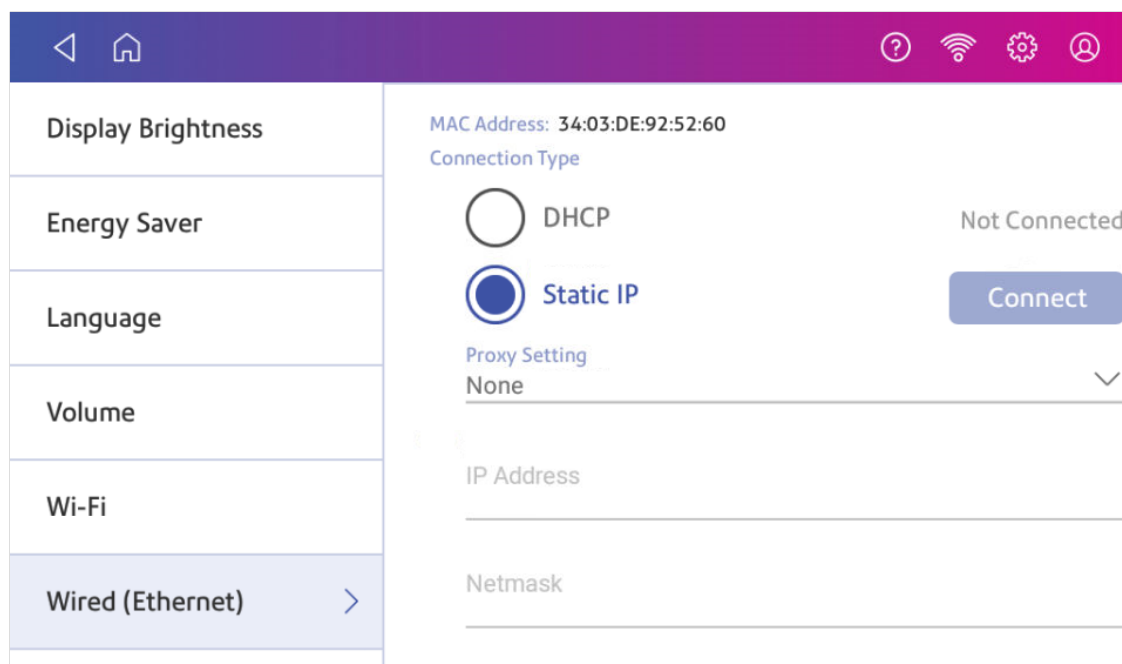

3. Select **Static**.

4. Contact your IT department to obtain the settings you will need to enter for your device. The values needed are:
  - **IP Address**
  - **Netmask**
  - **Gateway**
  - **DNS Address.**
5. Enter the settings you obtained in step 4 for the **IP Address**, **Netmask**, **Gateway**, and **DNS Address** in the corresponding fields.
6. Tap **Connect**.
7. If SendPro C, SendPro+ fails to connect, remove the network cable from the back of the device.
8. Tap **Connect**. Wait for the attempted connection to fail.
9. Plug the network cable back in.
10. Delete the values in the **IP Address**, **Netmask**, **Gateway**, and **DNS Address** fields.
11. Enter the **IP Address**, **Netmask**, **Gateway**, and **DNS Address** that you obtained in step 4.
12. Tap **Connect**.

## Setting up a wireless (Wi-Fi) network connection

You can connect your SendPro C, SendPro+ with a wireless network connection.

1. Tap **Settings**.



2. Tap **Wi-Fi** in the Device & Network section.
3. Choose your Wi-Fi network from the list. Tap **Add Network** if your Wi-Fi network does not appear.
4. Enter your Wi-Fi password.  
**Tip:** Use the show password option to make sure that you enter your password correctly.
5. Tap **Advanced Options** if your network requires advanced network settings such as a Static IP address:
  - To set up a Static IP address:
    - a. Select the **IP Setting** menu and choose **Static**.
    - b. Tap on the line and enter the value provided by your IT department.
    - c. Tap the > in the green circle.

## Connecting to a hidden Wi-Fi network

Add a network when you want to connect using Wi-Fi and your network is not present in the Wi-Fi list.

1. Tap **Settings**.



2. Tap **Wi-Fi** in the Device & Network section to see a list of available networks.

3. Tap **Add Network** at the top of the Wi-Fi screen.

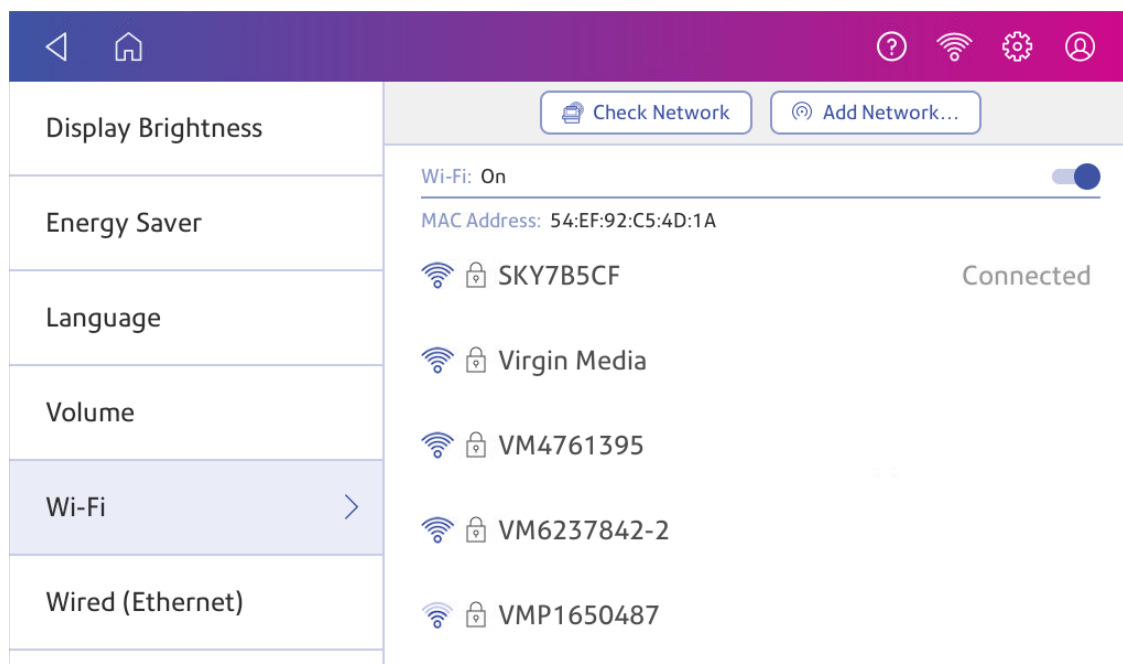

4. For each of the following steps, please consult with your IT department to obtain the necessary information.
  - a. Tap the down arrow in the Security field and select the security method.

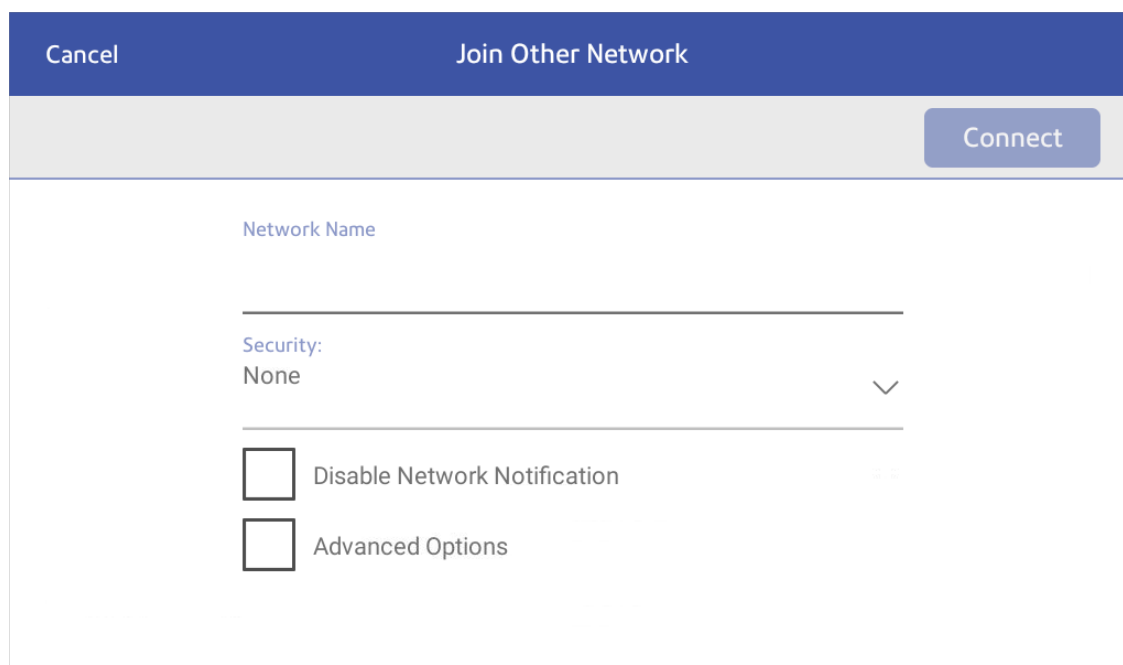

- b. Tap **Advanced Options** to enter a static IP or set up a proxy.
5. Tap **Connect** when done.

# Forgetting a Wi-Fi network

Forget a Wi-Fi network if:

- You do not want your device to automatically connect to that network or
- You need to resolve a wireless network issue.

1. Tap **Settings**.



2. Tap **Wi-Fi** in the Device & Network section.

3. Tap the network you want to forget. Note that you can only forget a network to which you have previously connected.

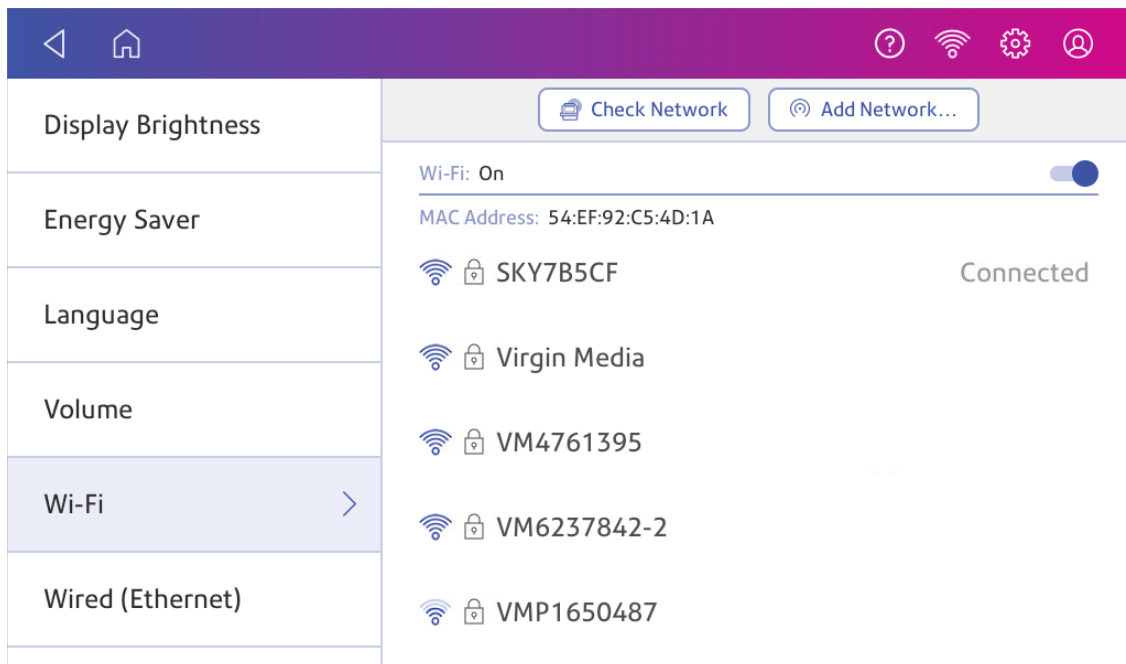

The network details appear.

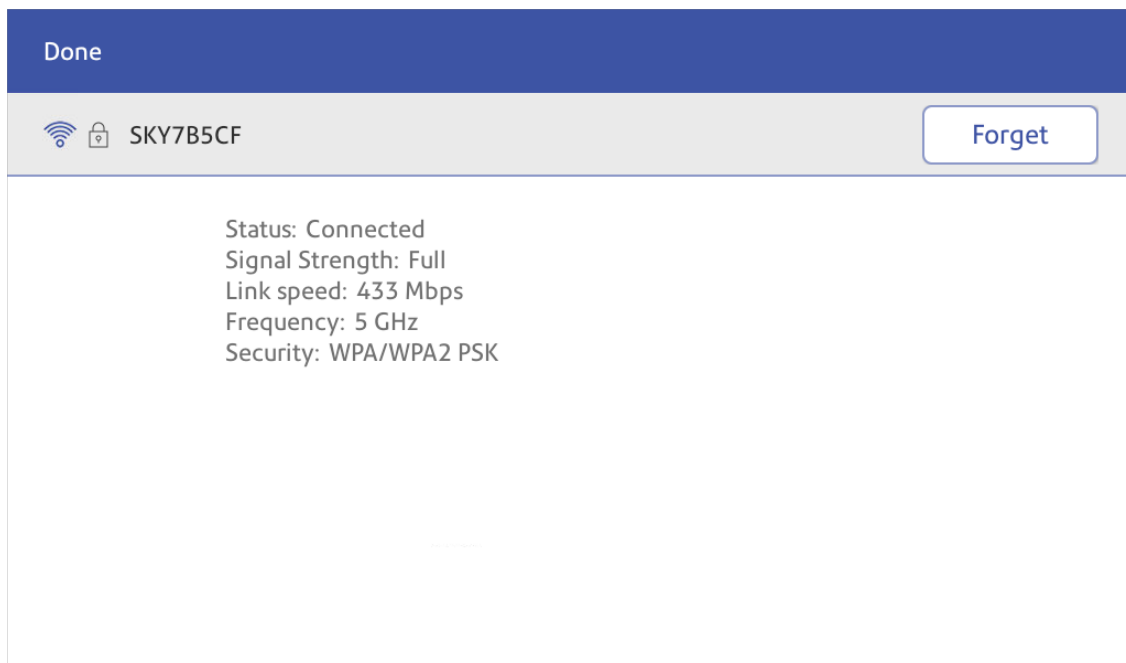

4. Tap **Forget** to forget the network connection.

## Checking your network connection

Use the Network Connection app to check that you have the necessary internet services to connect to the internet. The app helps diagnose network connection issues.

Your IT department may be blocking certain services. Only they will know if the necessary services are available on your network.

1. To open and run the network checking app:
  - Tap **SendPro Apps** on the Home screen, then tap **Network Connection**.
2. The device then provides you with the results of the network check.
3. Tap **Close** twice to return to the Home screen.

## Finding the MAC address for wired and wireless networks

The MAC address is the network identifier for the device. IT uses it to allow the device onto the network.

Your device contains two MAC addresses: One for wireless connections and one for wired connections.

### Locating the MAC address for wireless connections

1. Tap **Settings**.



2. Tap **Wi-Fi**.

- The MAC address appears above the list of wireless networks.

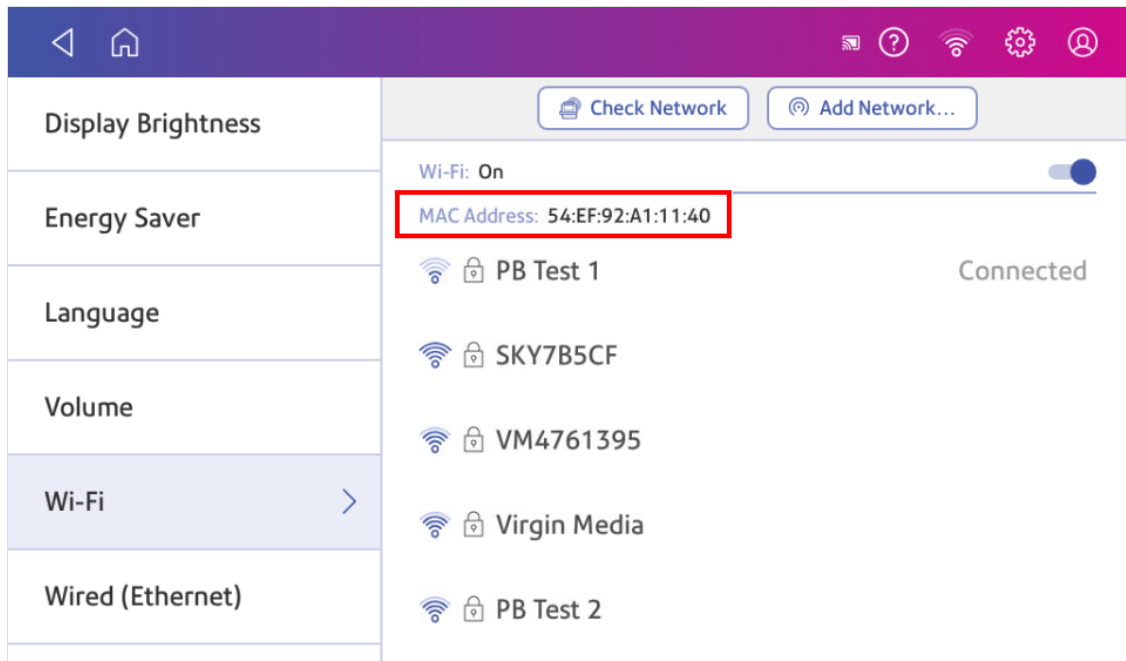

## Locating the MAC address for wired connections

- Tap **Settings**.



2. Tap **Wired (Ethernet)**. The MAC address is present at the top of the screen.

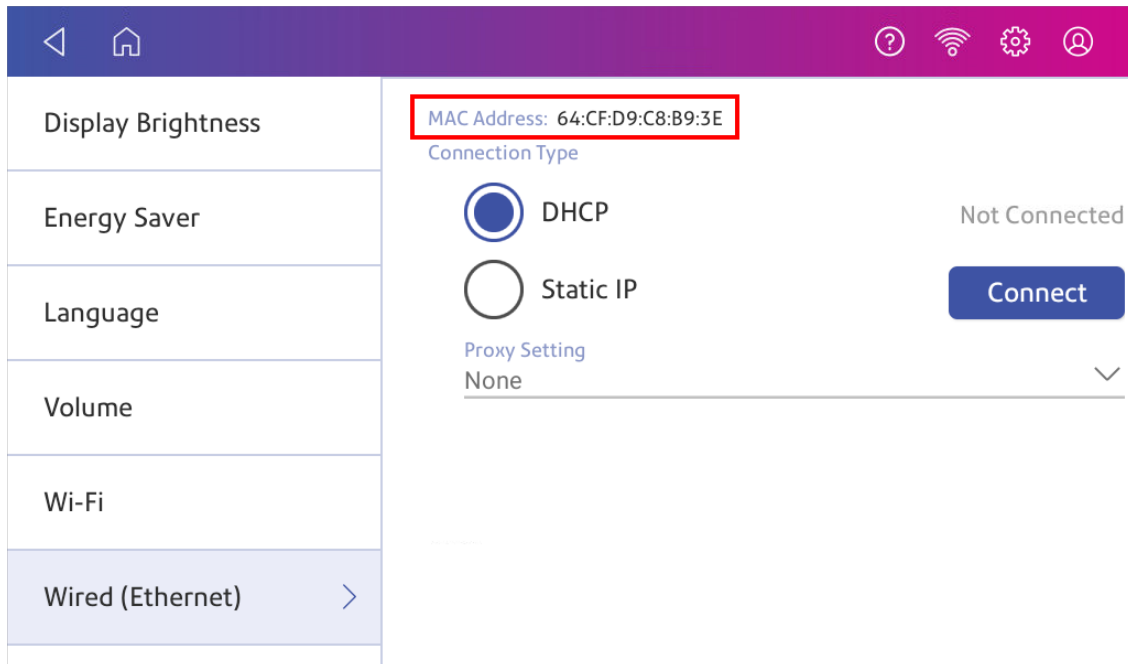

3. Tap **Check Network**. The Checking Network Connection screen appears.



4. Tap **View Details** in the Connected to wired network box when the test finishes.

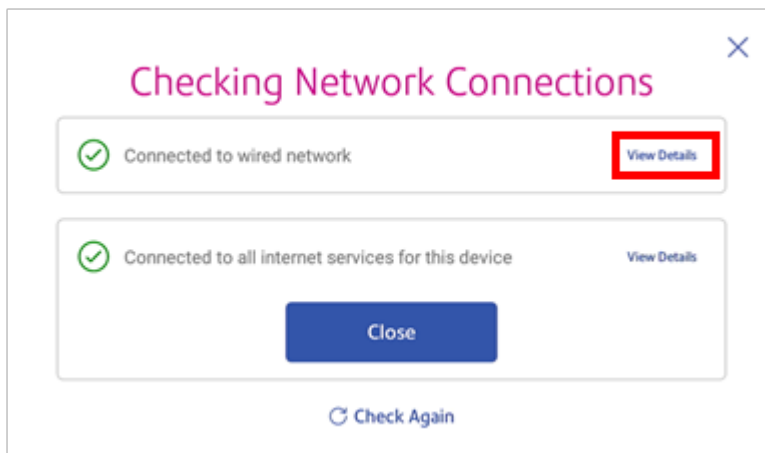

The MAC address appears:

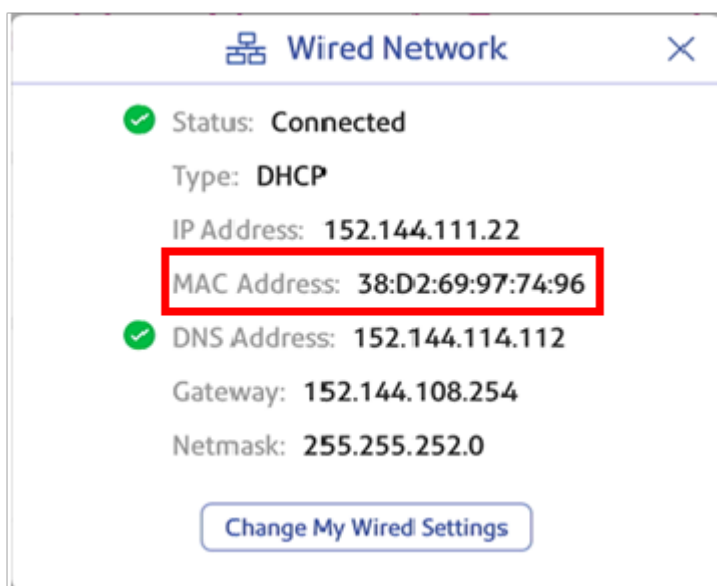

5. Tap **X** to close this window.
6. Tap **Close**, then the **back arrow** to return to the Home screen.

**If the MAC address does not appear, try these steps:**

1. Tap **Settings**.



2. Scroll down to the Advanced Device Options section and tap **About This Device**.

3. Scroll down to the Base Network Info section to locate the MAC Address.

Cancel	System Info	Upload Report
Base Network Info		Rates
DHCP	Disabled	Rate Manager version
DNS0	192.168.0.1	11.05
DNS1	null	
DNS2	null	Weight units
DNS3	null	METRIC
Gateway	192.168.10.244	
IP	0.0.0.0	Module count
IPV6	null	Total:7
IPV6LINK	null	Active rating:7
LanState	false	Module info
<b>MacAddress</b>	<b>64:CF:D9:C8:B9:3E</b>	CCF: HZAU000.H.01
Name	eth0	HZAU001.C01 ID: 49
Netmask	0.0.0.0	HZAU002.C01 ID: 50
Wifi Network Info		HZAU003.C01 ID: 51
IP	192.168.0.80	HZAU004.D01 ID: 52
Gateway	192.168.0.1	
Netmask	255.255.255.0	

4. Tap **Cancel** to return to the Home screen.

## Setting up a Proxy server

A Proxy server is a computer that acts as a gateway between your local network, your device, and the internet. Proxy servers provide increased performance and security.

If your network requires a proxy server, you must contact your IT department or service provider to obtain the proxy server information to set up a proxy server.

### Choose the connection type

Choose how you connect your device to set up a Proxy server:

- [Setting up a Proxy server using a Wi-Fi network connection](#)
- [Setting up a Proxy server using a wired network connection](#)

## Setting up a Proxy server using a Wi-Fi network connection

1. Tap **Settings**.



2. Tap **Wi-Fi** in the Device & Network section.
3. Select the network from the list.
4. Tap on the **Advanced Options** checkbox to select it.
5. Scroll down and tap the arrow next to Proxy, then select **Manual**.

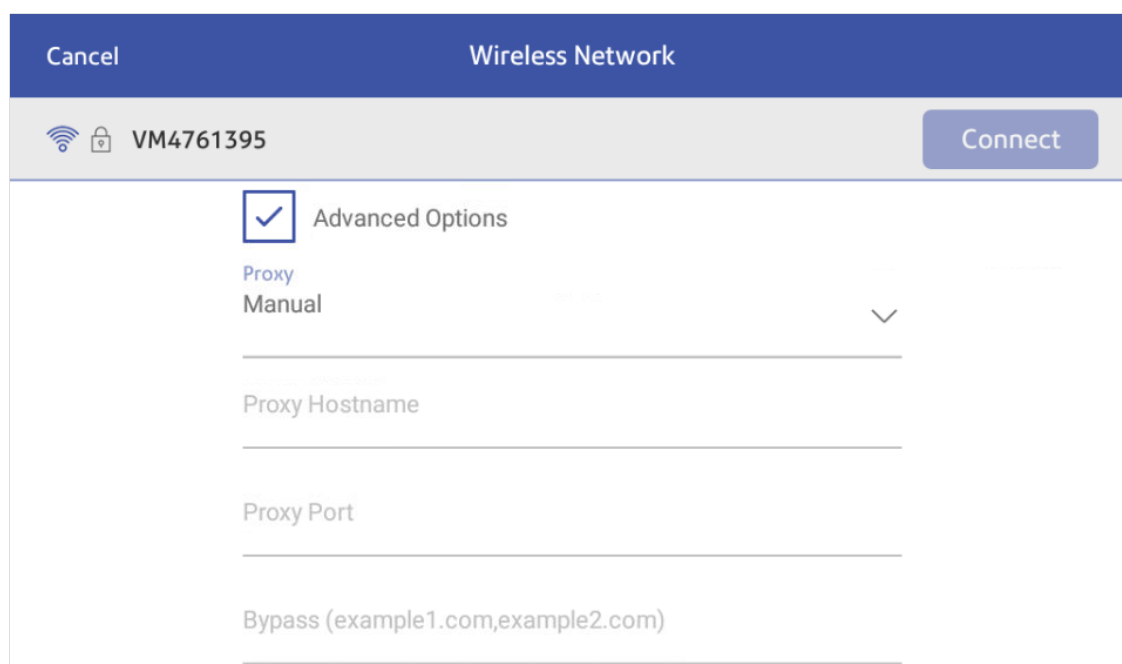

6. Enter the IP address, HTTP or HTTPS proxy address of your proxy server in the **Proxy Hostname** field.
7. Enter the port number for the proxy server in the **Proxy Port** field.
8. (Optional) Enter any specific URLs or URL patterns (such as internal addresses) that you wish to bypass the proxy in the **Bypass** field.
9. If your Proxy Server requires authentication, select the **Need Authentication** check box. Additional fields appear.
  - a. Enter the Proxy username in the **Proxy Username** field. This may be case sensitive for some proxy servers.
  - b. Enter the Proxy password in the **Proxy Password** field. This is case sensitive for proxy servers.

## Setting up a Proxy server using a wired network connection

1. Tap **Settings**.



2. Tap **Wired (Ethernet)** in the Device & Network section.
3. Select either **DHCP** or **Static IP**.
4. If you select DHCP, tap on the drop-down arrow next to Proxy Setting and select **Manual**.

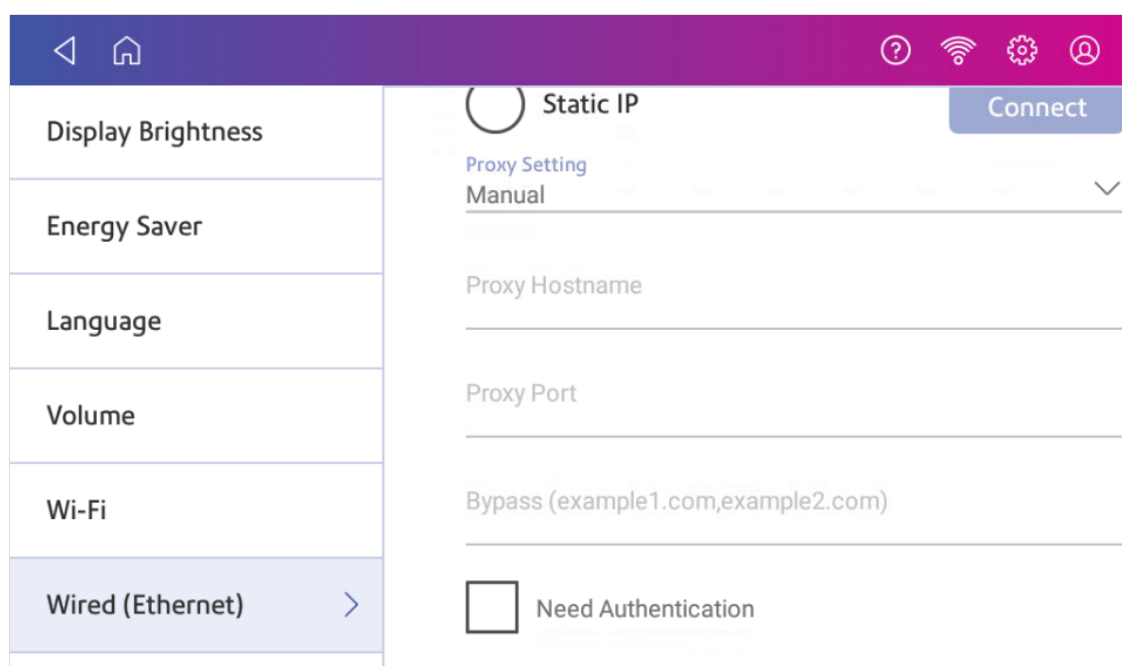

5. Enter the IP address, HTTP or HTTPS proxy address of your proxy server in the **Proxy Hostname** field.
6. Enter the port number for the proxy server in the **Proxy Port** field.
7. (Optional) Enter any specific URLs or URL patterns (such as internal addresses) that you wish to bypass the proxy in the **Bypass** field.
8. If your Proxy Server requires authentication, select the **Need Authentication** check box. Additional fields appear.
  - a. Enter the Proxy username in the **Proxy Username** field. This may be case sensitive for some proxy servers.
  - b. Enter the Proxy password in the **Proxy Password** field. This is case sensitive for proxy servers.

# 3 - Scales and Weighing

## In this section

Using the scale when printing postage.....	42
Entering the weight manually when printing postage.....	42
Zeroing the scale.....	43

## Using the scale when printing postage

Use the scale to weigh your mail and calculate the correct postage for you.

1. Tap **Envelope Printing** on the Home screen.
2. Tap **Weight**.

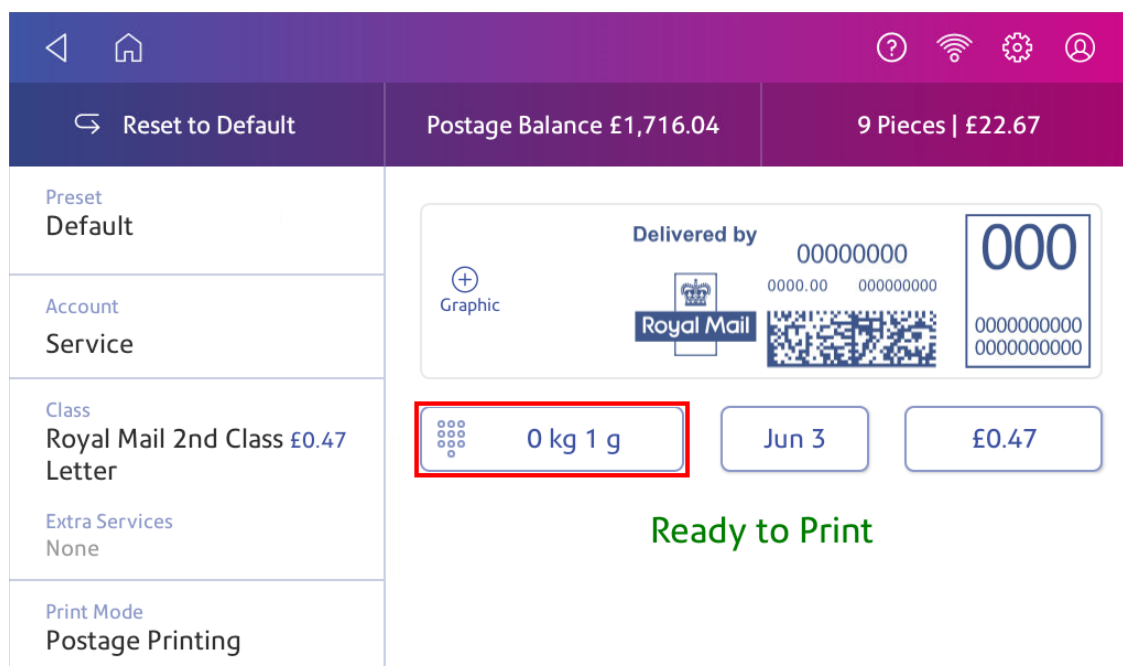

3. Tap **Scale**.
4. Place the envelope on the scale. You must do this before the next step or else the **Apply** button remains inactive.
5. Tap **Apply**.
6. Tap **Class**.
7. Select **Start Over** to show the class options.
8. Tap the class you want.
9. Select special services, if required.
10. Tap **Apply**.
11. Insert the envelope into the device. The device prints the postage.

## Entering the weight manually when printing postage

Enter the weight of a mailpiece when you know its weight and are not using the scale.

1. Tap **Envelope Printing** on the Home screen.
2. Tap **Weight**.

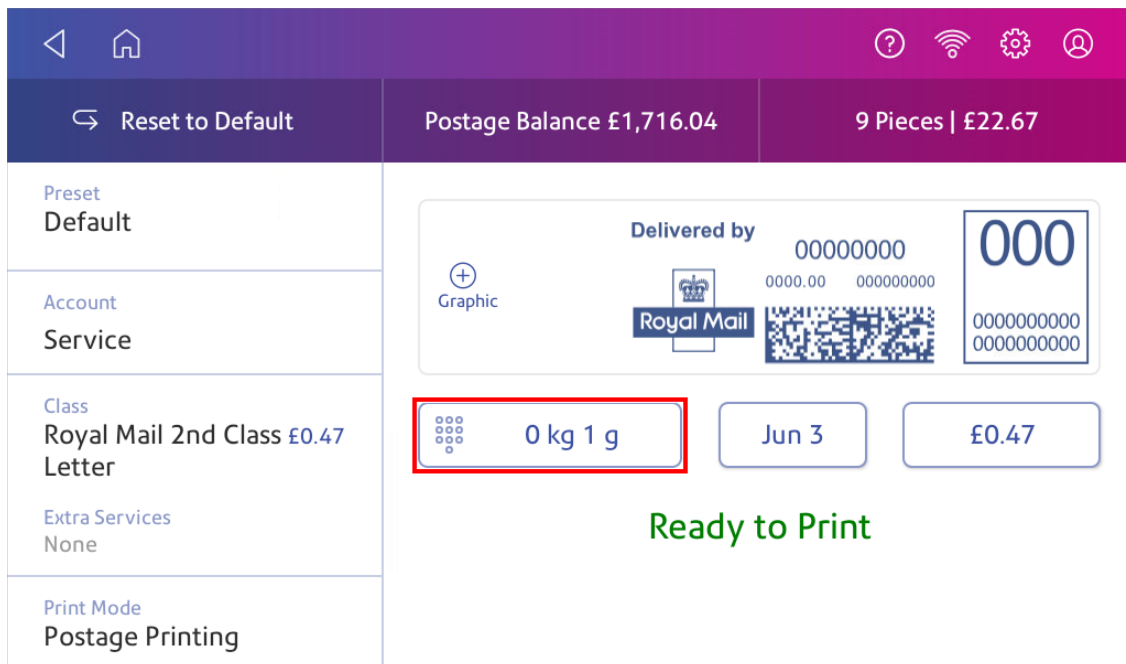

3. Tap **Manual**.
4. Enter the **kilograms** and **grams**.
5. Tap **Apply**.
6. Tap **Class**.
7. Tap **Start Over** to see all the class options.
8. Select the class and any special services required.
9. Tap **Apply**.
10. Insert the envelope into the device. The device prints the postage.

## Zeroing the scale

Zero the scale to set the weight to zero.

Make sure there is nothing on the scale when you zero it.

1. Tap **Envelope Printing** on the Home screen.
2. Tap **Weight**.

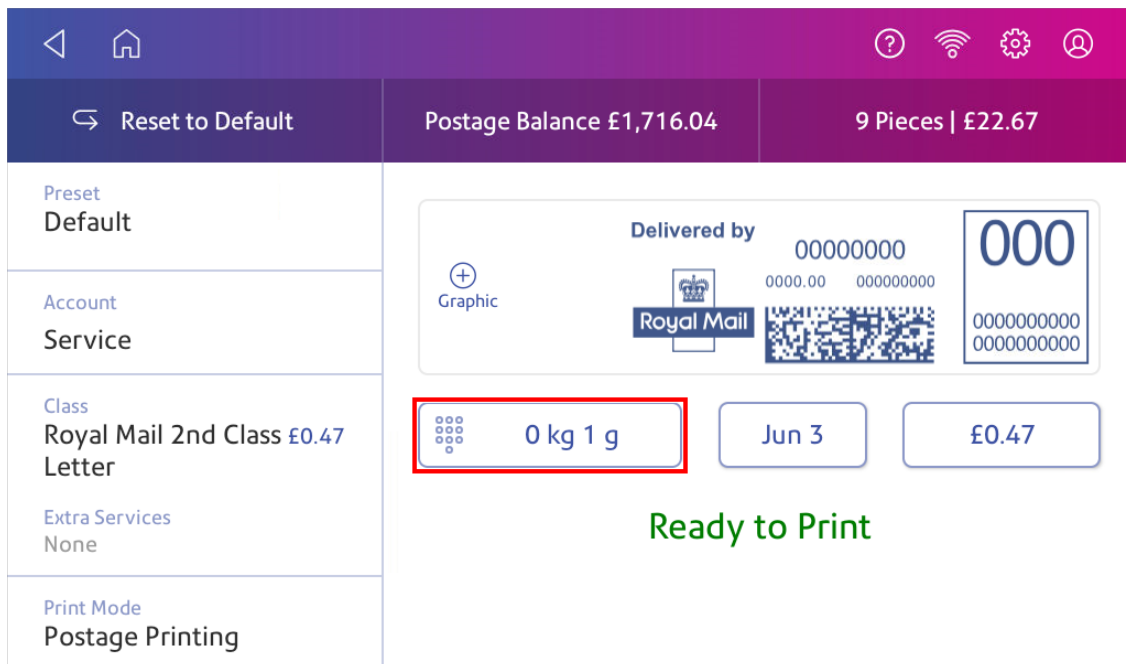

3. Tap **Scale** on the weighing method screen.
4. Tap **Zero Scale**.
5. Tap **Cancel** to return to the Envelope Printing app.



# 4 - Accounting

## In this section

---

What is Accounting.....	46
Adding an account.....	47
Turning Envelope Printing account passwords on or off.....	48
Selecting an Envelope Printing account.....	50
Editing an account.....	50
Making an account inactive.....	51
Deleting an Envelope Printing account.....	52

## What is Accounting

You can use the accounting feature to track the postage that departments or individuals within your organization use.

The accounting feature helps you to understand how your business spends its postage and identify cost-saving opportunities. You can charge postage back to departments or clients and report on postage expenditures.

The Envelope Printing app uses a multi-level account format. It is different from the Parcel Shipping Cost Accounts.

When you use Envelope Printing accounts to track your postage usage, use sub accounts and sub sub accounts to analyze your usage within an account.

How you create accounts depends on your needs. You can create accounts in single or multiple levels. For example, you can divide a top level department (account) into two additional sub sections (sub accounts and sub sub accounts).

The Envelope Printing accounting structure can have up to a three level hierarchy:

- account (top level of the hierarchy)
- sub account (next possible level of the hierarchy)
- sub sub account (last possible level of the hierarchy)

**Important:** Only the lowest level of the account hierarchy is chargeable. This means that the lowest level of the account has the transactions applied to them.

- **Account with no sub accounts** - When you create an account with no sub accounts, you charge postage to that account. This is because the account does not have sub or sub sub accounts.
- **Account with sub account or sub sub account** - When you create a sub account or sub sub account, you charge postage to the lowest level (the sub account or sub sub account).

## Account hierarchy examples

### Top level account

- Engineering

### Account with sub accounts

- Engineering; Sub account - Software;
- Engineering; Sub account - Hardware;

### Account with sub sub accounts

- Engineering; Sub account - Software; Sub sub account - Graphics and Layout; Sub sub account - Design
- Engineering; Sub account - Hardware; Sub sub account - Quality Approval; Sub sub account - Testing

## Adding an account

Add accounts to record Envelope Printing usage by department.

An account is created automatically for you during installation. The account is called General.

You can edit the name if you want to, providing you have not printed any post against it.

You can create more accounts if you would like to.

1. Tap **Envelope Printing** on the Home screen.
2. Tap **Account**.
3. Tap **Manage Accounts**.

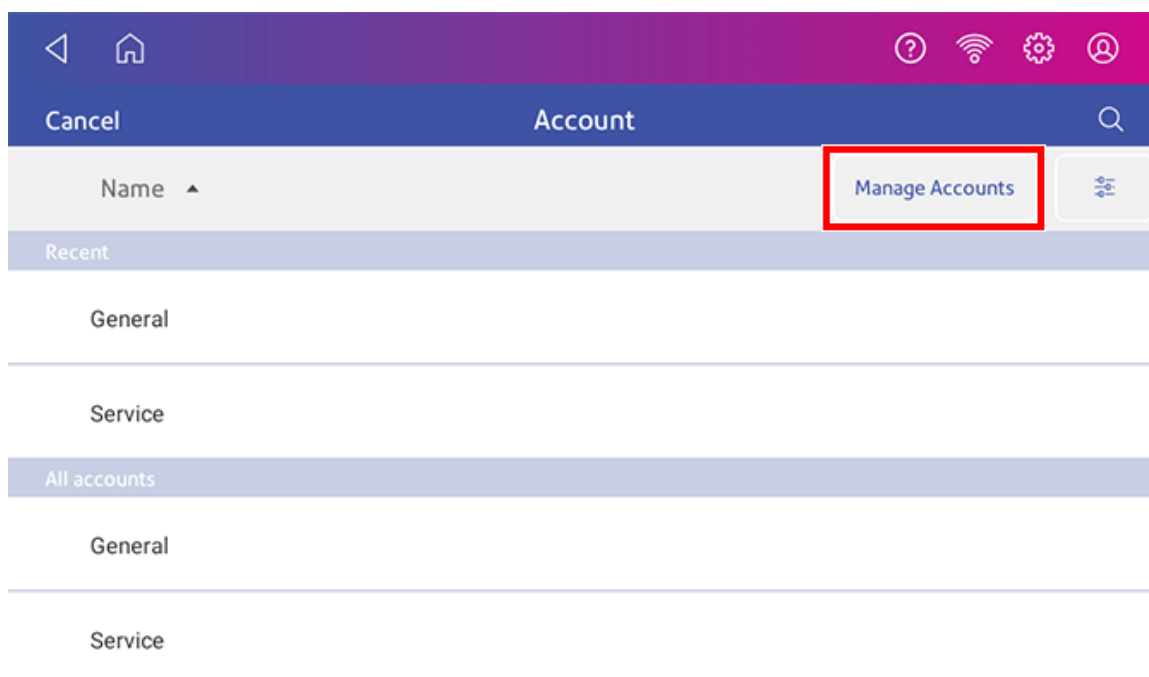

4. Tap **Create new account**.
5. Tap **Create a new account** for a new account.

6. Enter the account name in the Enter account name field. Account names can be up to 75 characters long.  
If the keyboard does not pop up, tap on the line in the gray box.

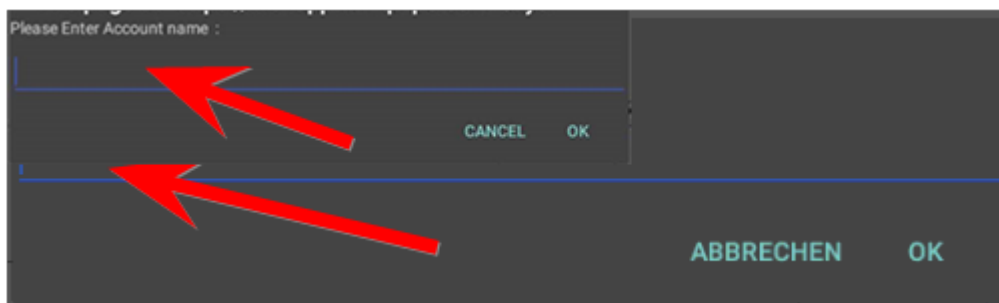

7. Tap **OK**.
8. Enter a unique code in the Code field to identify each account. Codes can be alphanumeric. Codes help you locate accounts more easily.
9. Tap **OK**.
10. You can use the optional fields, such as:
  - **Description** - Enter a description of the account up to 150 characters.
  - **Password** - Tap **Password** to add a password for an account.
    - Passwords are case sensitive, can be alphanumeric, and must be four characters in length. You must enter this password to edit or feed mail against the account once enabled.
11. Ensure you set the status to active.
12. Tap anywhere on the screen, but outside of the fields when complete.
13. Tap **OK** to save. The name of the new account appears.
  - Tap **Create New Account** to create another account.
  - Tap **Add a Sub Account to this account** to add a sub account to the account you just created.
  - Tap **Continue** if you do not need to create any more accounts.
14. Press the back arrow to return to the account list.

## Turning Envelope Printing account passwords on or off

You can protect each account from unauthorised access by turning account passwords on.

1. Tap **Envelope Printing** on the Home screen.
2. Tap **Account**.

3. Tap **Manage Accounts**.

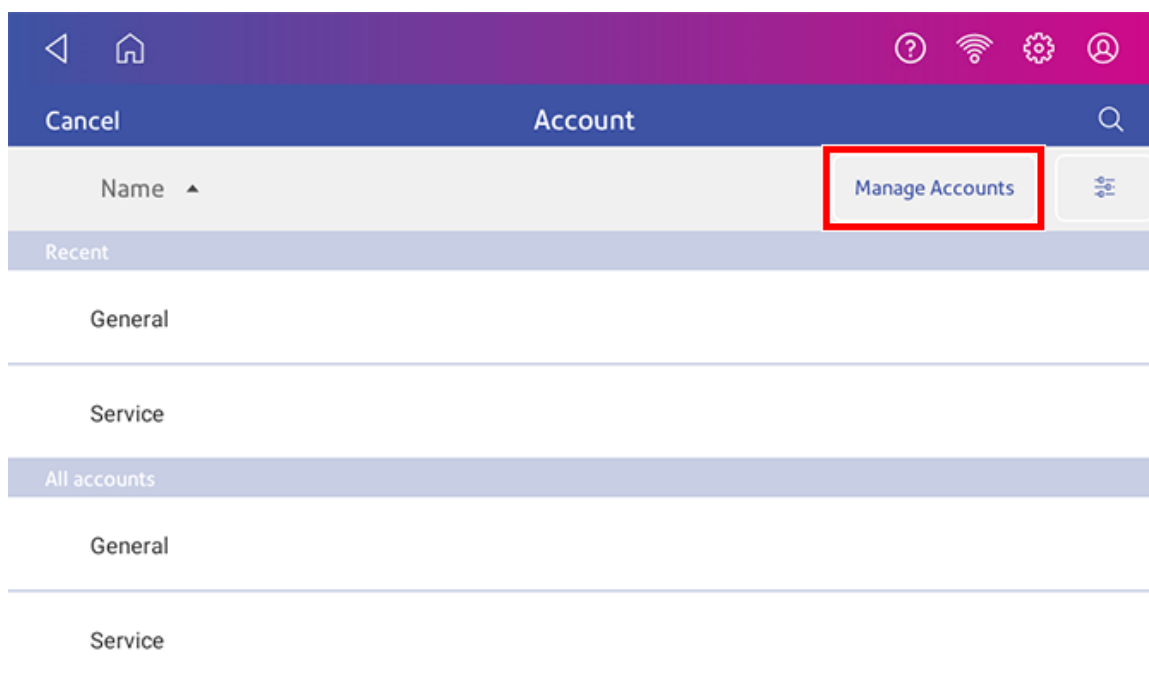

4. The Manage Accounts screen opens.

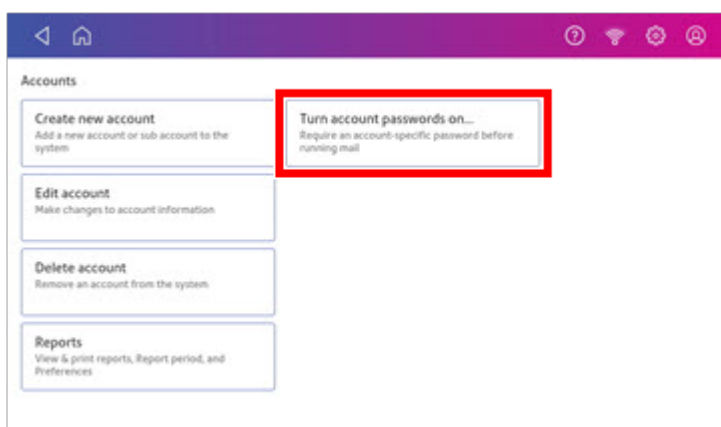

- Tap **Turn account passwords on** if account passwords are off and you wish to turn them on. Tap **Yes** then **OK**.
- Tap **Turn account passwords off** if account passwords are on and you wish to turn them off. Tap **Yes** then **OK**.

5. Tap the back arrow on the top left side of the screen to return to the list of accounts.

6. Tap **Cancel** to return to the Envelope Printing app.

## Selecting an Envelope Printing account

When accounting is enabled on your device, you must select an account before you can print postage.

You can then create a preset which you use to quickly select the same settings in the future.

1. Tap **Envelope Printing** on the Home screen.
2. Tap **Account**.
3. Tap the account you wish to use for your mail.

## Editing an account

Edit an account when you want to change the account name, code, description, status or password.

**Important:** Once you charge postage to an account, you cannot change the account name or code.

1. Tap **Envelope Printing** on the Home screen.
2. Tap **Account**.
3. Tap **Manage Accounts**.

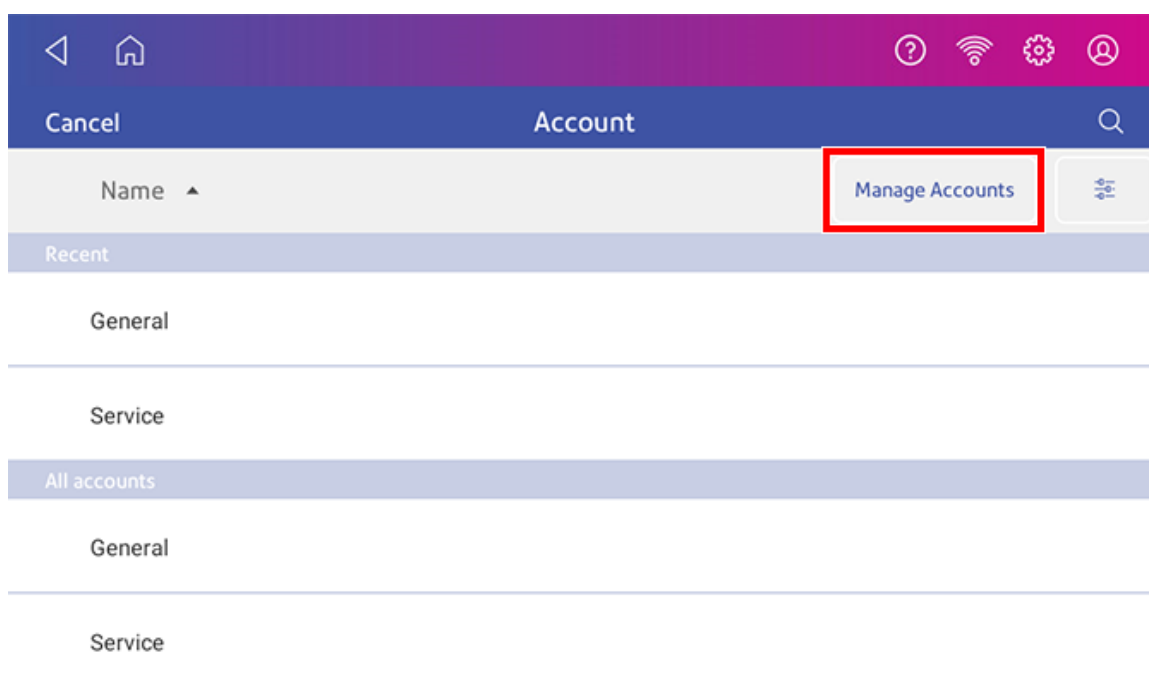

4. Tap **Edit account**.
5. Tap the account you want to edit.
6. Tap **OK**.
7. Make your changes, such as edit the account name, code, description, status or password.

8. When finished, tap anywhere on the screen, but outside of the fields.
9. Tap **OK** to return to the Accounts screen.
10. Tap the back arrow to return to the list of accounts.
11. Tap **Cancel** to return to the Envelope Printing app.

## Making an account inactive

Setting the account status to inactive prevents anyone from charging postage against an account.

1. Tap **Envelope Printing** on the Home screen.
2. Tap **Account**.
3. Tap **Manage Accounts**.

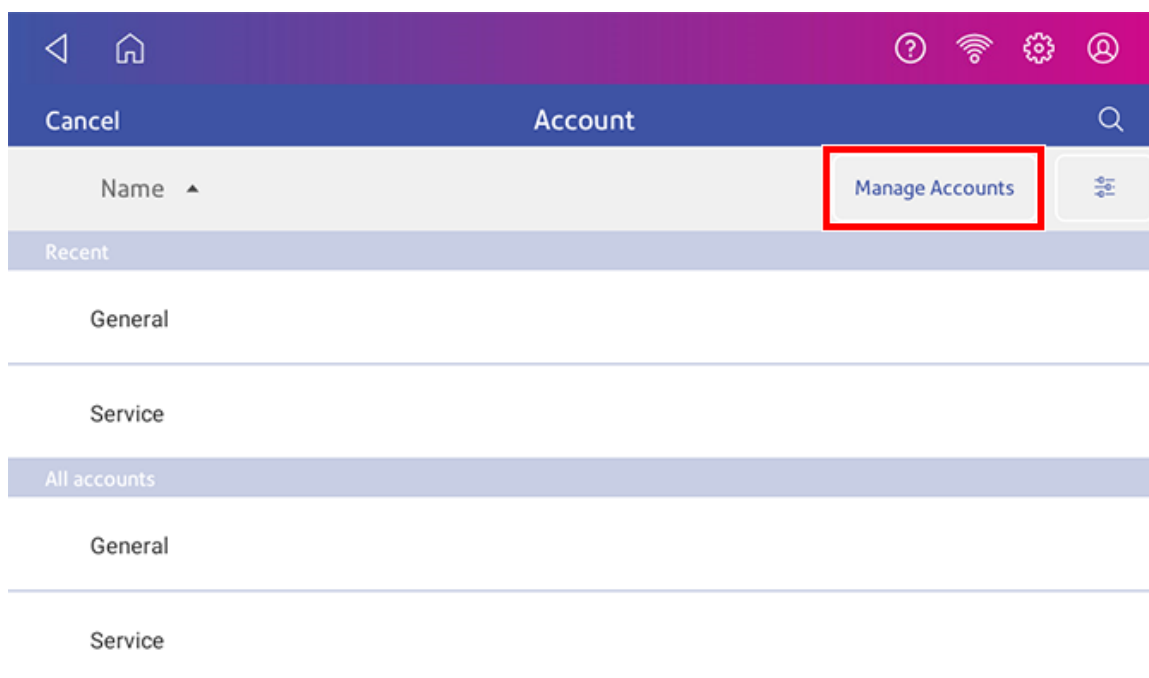

4. Tap **Edit account**.
5. Tap the account you want to make inactive.
6. Select **OK**.
7. Tap the **Inactive** button.
8. Tap **OK** to return to the Accounts screen.
9. Tap the back arrow to return to the list of accounts.
10. Tap **Cancel** to return to the Envelope Printing app.

## Deleting an Envelope Printing account

If you apply postage to an account you cannot delete the account. You can only make the account inactive.

Make sure you do not need an account's data before you delete an account. When you delete an account, sub account or sub sub account, you delete its data. You cannot recover that data.

Set an account status to inactive to prevent users from charging transactions against this account. To prevent misallocation of postage funds you will need to correct, update or delete any presets that have an inactive account associated with them.

1. Tap **Envelope Printing** on the Home screen.
2. Tap **Account**.
3. Tap **Manage Accounts**.

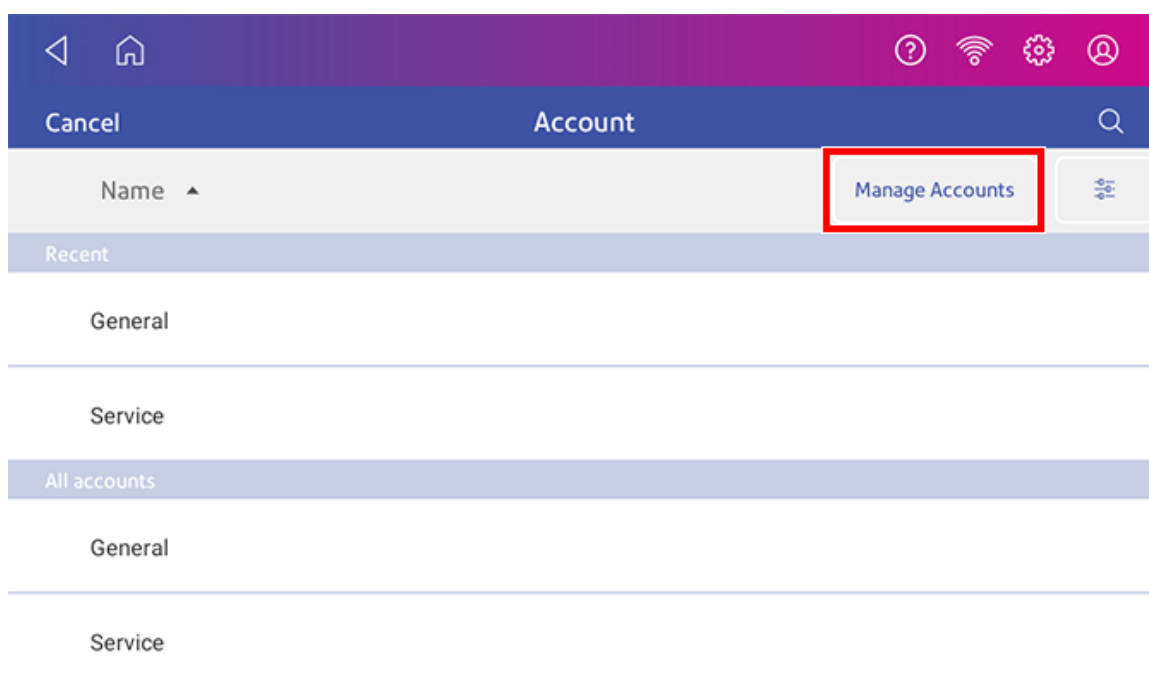

4. Tap **Delete account**. The list of available accounts appears.
5. Tap the account you want to delete.
6. Tap **OK**.
7. Tap **Yes, delete account** to confirm.
8. Tap **OK**.
9. Tap the back arrow to return to the list of accounts.
10. Tap **Cancel** to return to the Envelope Printing app.



# 5 - Postage Funding

## In this section

Checking the available funds for printing postage.....	54
Refilling postage funds for printing postage.....	55
Getting a Royal Mail refund for damaged or incorrectly printed mail.....	56
Changing the default refill amount for printing postage.....	57
Setting the low funds warning for printing postage.....	58

# Checking the available funds for printing postage

## Viewing the amount available in your device

1. Tap **Envelope Printing** on the Home screen.
2. The **Postage Balance** shows the available funds in your device.

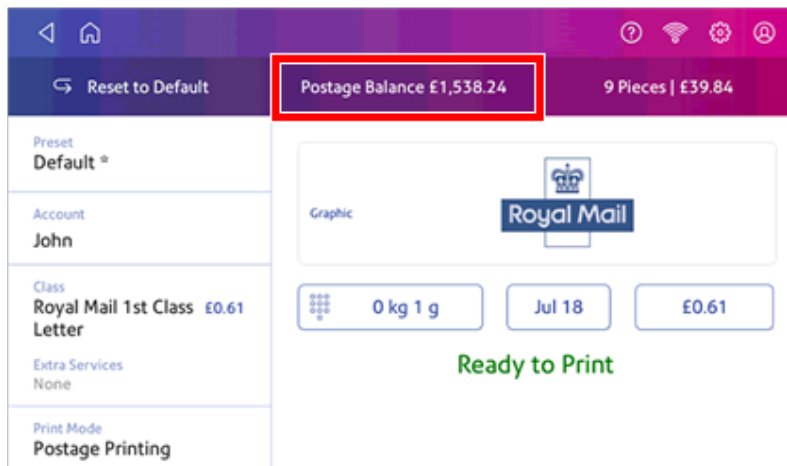

## Viewing the amount available in your postage account at Pitney Bowes

1. Tap **Envelope Printing** on the Home screen.
2. Tap **Postage Balance**.
3. Tap **Refill Settings**.

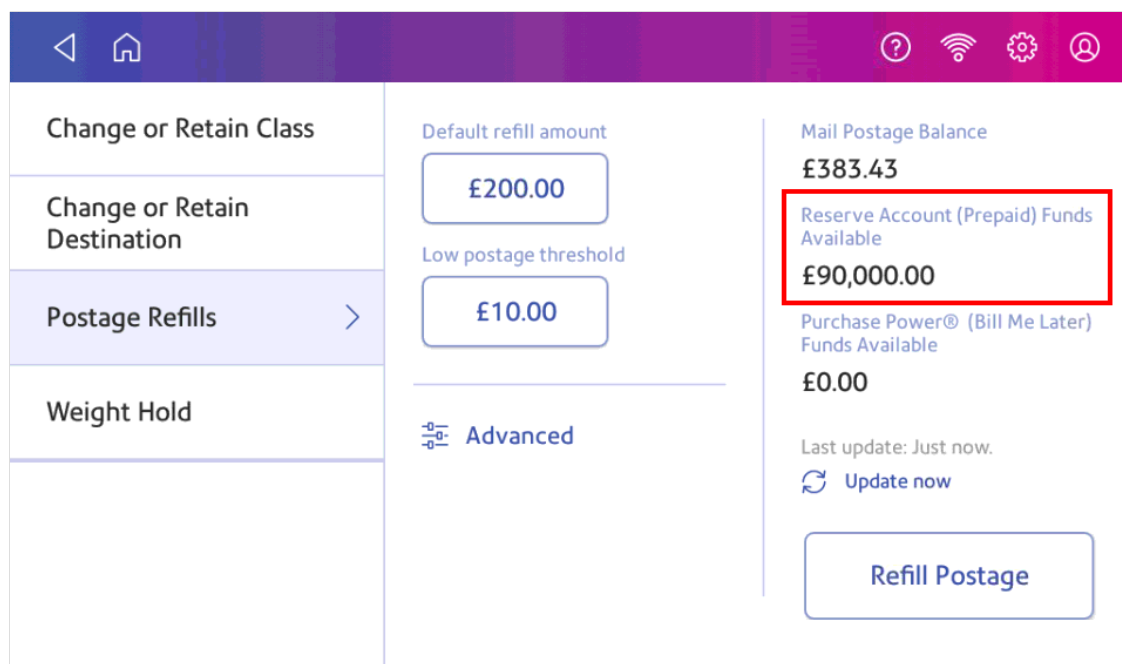

## Refilling postage funds for printing postage

Refill your postage funds for printing postage as soon as you receive a message that your funds are low.

### Before you begin

Check that your device is connecting to the internet.

- For wired network connections, you will see the following connection image in the toolbar:



- If you have a wireless connection, you will see the following connection image in the toolbar:



To refill postage:

1. Tap **Envelope Printing** on the Home screen.
2. Tap **Postage Balance**.
3. Tap **Refill Postage**.
4. Enter the postage refill amount.
5. Tap **back** to change the amount shown.



6. Tap **Refill Mail Postage**.
7. Tap **View Receipt** to view or print a receipt.
8. Tap **Done**. Your updated postage balance appears on the Envelope Printing app.

## Getting a Royal Mail refund for damaged or incorrectly printed mail

Once you print an impression, your device deducts the postage amount from the postage funds. This happens even if the printing is illegible. Therefore, it is important you select the correct value before printing postage.

For up-to-date refund guidelines, refer to the Royal Mail website.

To request a refund via Royal Mail:

1. Don't post the items.
  2. Remove the contents and start again with a new envelope.
  3. Send any unused franked envelope (the whole envelope) to:
    - Royal Mail Franking
    - Stone Hill Road
    - Farnworth
    - Bolton
    - BL4 9XX
- The affected mail must be at least £10 in total value.
  - All the impressions must be clear and readable and made within six months of the franked date.
  - You will receive a cheque refund for the value of the unused impressions minus a 15% administration fee.

## Changing the default refill amount for printing postage

Change the default refill amount to store an amount you want to refill your device with.

You can set the default refill amount during installation or change it at later time.

There are two ways to change the default refill amount:

From the Home Screen:

1. Tap **Settings**.



2. Scroll down to the Envelope Printer Settings section.
3. Tap **Postage Refills**.
4. Tap the box under **Default refill amount**.
5. Tap the back key to remove the existing amount. You may need to tap the key multiple times to clear the amount.
6. Enter the new amount.
7. Tap **Apply**.
8. Tap the back arrow to return to the Home screen.

From Envelope Printing:

1. Tap **Envelope Printing** from the Home screen.
2. Tap **Postage Balance**.
3. Tap **Refill Settings**.

4. Tap the box under **Default refill amount**.
5. Tap the back key to remove the existing amount. You may need to tap the key multiple times to clear the amount.
6. Enter the new amount.
7. Tap **Apply**.
8. Tap the back arrow to return to the Envelope Printing app.

## Setting the low funds warning for printing postage

Set the low funds warning to warn you when your available funds for printing postage reaches a certain amount. Use this warning as a reminder to add more postage to your device.

1. Tap **Envelope Printing** on the Home screen.
2. Tap **Postage Balance**.
3. Tap **Refill Settings**.
4. Tap **Low postage threshold**.
5. Tap **back** on the keypad to remove the existing amount.
6. Enter the new amount.
7. Tap **Apply**.
8. Tap **back** to return to the Envelope Printing app.

# 6 - Mailing and Shipping

## In this section

---

Signing in to and out of the Parcel Shipping app.....	60
Printing a shipping label.....	60
Printing a shipping label from the Address Book.....	67
Tracking a shipment.....	67
Adding a new sender address for shipping labels.....	67
Editing the sender address for shipping labels.....	67
Reprinting a shipping label.....	68
Getting a refund for a shipping label.....	68
What are shipping Cost Accounts?.....	68
Turning cost accounts on or off for shipping labels.....	69
Adding a shipping label cost account.....	69
Modifying a shipping labels cost account.....	70
Adding a shipping labels preset.....	71
Setting a transaction limit for shipping labels.....	72
Setting the label options for shipping labels.....	72
Emailing tracking numbers for shipping labels.....	72
Use SendPro Online to perform these tasks.....	73
Sending post by First Class.....	74
Sending a large First Class envelope.....	74
Sending an international letter.....	74
Sending post using Special Delivery rates.....	75
Sending post using Signed For rates.....	81
Viewing and exporting Special Delivery and Signed For tracking numbers in Inview.....	86

## Signing in to and out of the Parcel Shipping app

In order to create and print shipping labels you need to sign in to your shipping labels account. You can also prevent unauthorised printing of labels by signing out of your account when you are away from your device.

### Signing in

Tap **Parcel Shipping** on the Home screen to sign in to the Parcel Shipping app. You need to enter a name and password.

### Signing out

1. Tap the user profile icon in the upper right corner of the toolbar to sign out of shipping labels.



2. Select **Sign out**.

## Printing a shipping label

Print Parcel Shipping labels to get the best pricing for Royal Mail or ParcelForce® parcel services.



1. Tap **Parcel Shipping** on the Home screen.
2. Tap **Royal Mail and ParcelForce**.

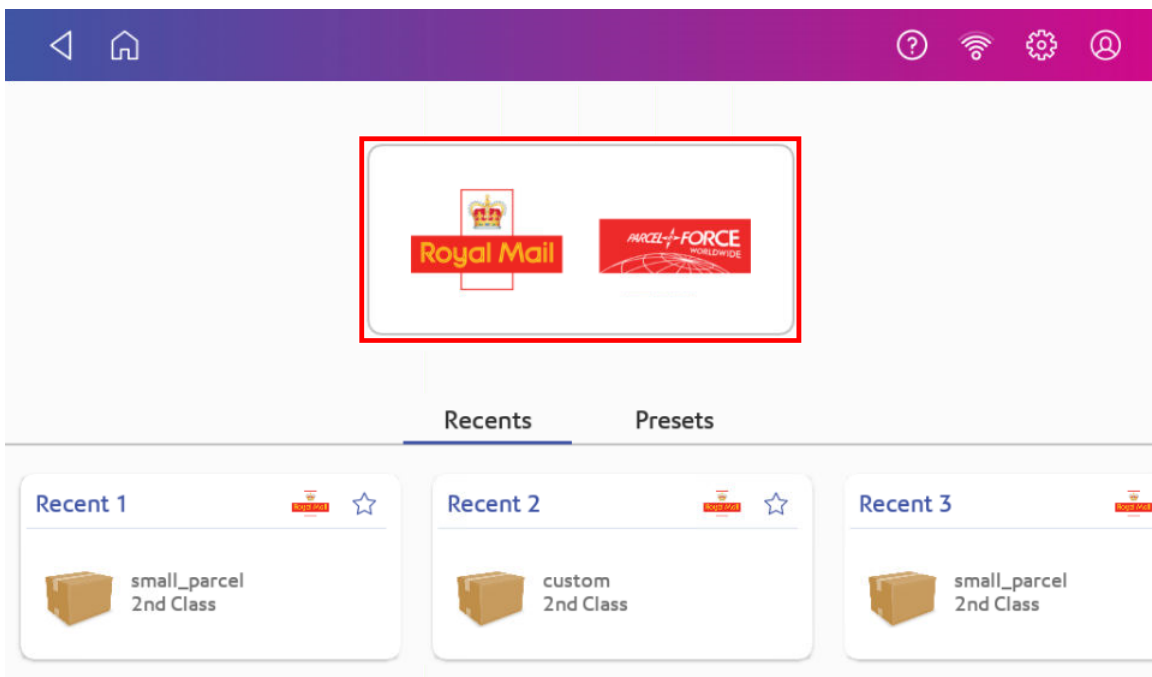

3. Add the sender address if required. Use the address book or enter it manually.

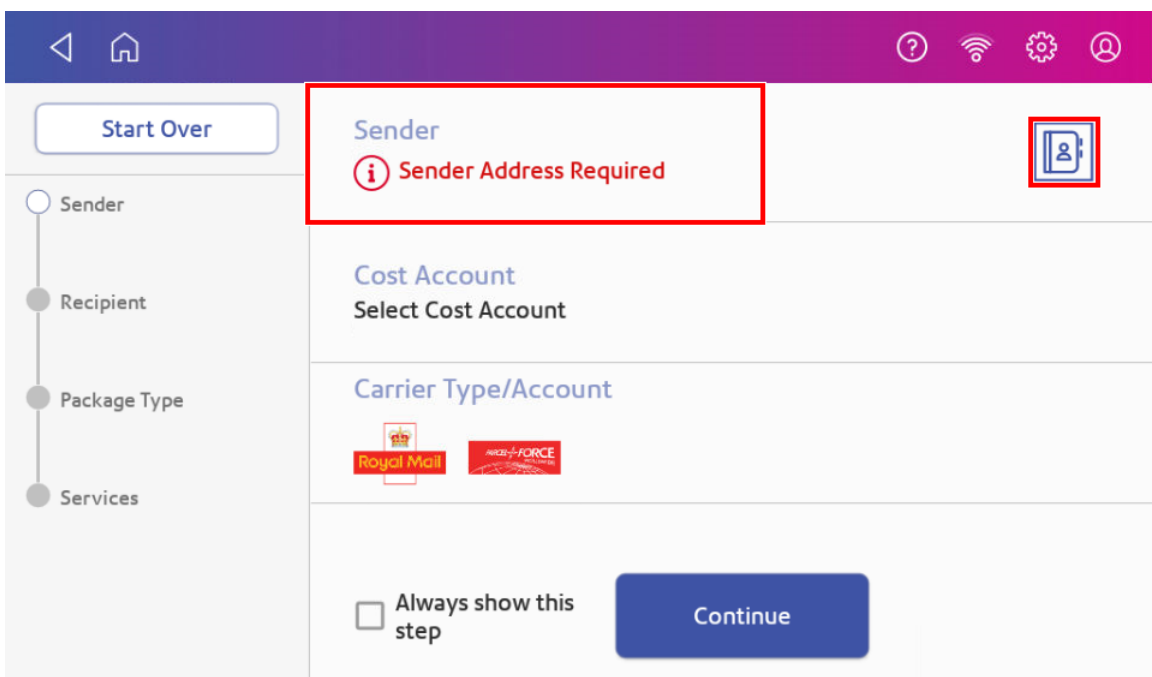

- Select a cost account, if enabled. If this field contains an account, check the account is correct.

Sender  
PITNEY BOWES LTD  
SENDPRO ENGINEERING UNIT, UNIT 5 TRIDENT PLACE  
MOSQUITO WAY, HATFIELD AL10 9UJ

**Cost Account**  
Select Cost Account

Carrier Type/Account

Royal Mail Priority Force

Always show this step

Continue

- Tap **Continue**.
- Tap the **Address** icon to select the recipient address from the address book. Alternatively, manually enter a postcode and scroll to the desired address. Tick the **Save contact** box to save the address to the address book.

Country  
United Kingdom

Postcode  
SW1W 0BD

Name  
Mr Test

Company(Optional)  
Test company

Address Line 1  
1 Grosvenor Gardens

City  
LONDON

County(Optional)

Email(Optional)

Phone(optional)

Save contact

Continue

- Tap **Continue**.
- Enter the size of the parcel in centimeters within the Dimensions boxes.

9. Tap **Weight**.

10. There are two options to now choose:

- Tap **Scale**, then place the parcel on the scale. Tap **Apply**, then **Continue** or
- Manually enter the weight of the parcel if you know the weight. Tap **Apply**, then **Continue**.

11. Tap the service you wish to use, in this example, **1st Class**.

Carrier	Mail Class	Delivery	Price
Royal Mail	<b>2nd Class</b> Delivery in two to three working days for less urgent mail	2-3 Business Days	£2.95 VAT exempt
Royal Mail	<b>1st Class</b> Next-day delivery aim for letters and parcels	1-2 Business Days	£3.58 VAT exempt
Royal Mail	<b>Signed for 2nd Class</b> With a signature on delivery for peace of mind	2-3 Business Days	£3.95 VAT exempt
Royal Mail	<b>Signed for 1st Class</b> Signature on delivery and next-day delivery aim	1-2 Business Days	£4.58 VAT exempt

Total: £3.58 (VAT Exempt)

Print

12. Tap **Extra Services** if required. If you are not adding any special services, go to step 15.

The screenshot shows a mobile application interface for selecting shipping services. On the left, a sidebar lists the sender (PITNEY BOWES LTD), recipient (alan robinson), package type (custom), and selected service (Special Delivery). The total price is £6.45 (VAT Exempt). The main area displays a table of shipping options:

Carrier	Mail Class	Delivery	Price
Royal Mail	<b>Signed for 2nd Class</b> With a signature on delivery for peace of mind	2-3 Business Days	£3.95 VAT exempt
Royal Mail	<b>Signed for 1st Class</b> Signature on delivery and next-day delivery aim	1-2 Business Days	£4.58 VAT exempt
Royal Mail	<b>Special Delivery Guaranteed by 1pm</b> Guaranteed by 1pm next-day	1 Business Day	£6.45 VAT exempt
express48	within 2 working days	2 Business Days	£8.30 before VAT

The 'Special Delivery Guaranteed by 1pm' option is highlighted with a red box and includes an 'Extra Services' button.

The screenshot shows the same mobile application interface, but with 'express24' selected as the service. The total price is now £10.44 (Including VAT). The shipping options table is updated:

Carrier	Mail Class	Delivery	Price
Royal Mail	<b>by 1pm</b> Guaranteed by 1pm next-day	1 Business Day	VAT exempt
express48	within 2 working days	2 Business Days	£8.30 before VAT
express24	next working day by close of business	1 Business Day	£8.70 before VAT
You will need to drop off the parcel. Select <i>Extra Services</i> for collection.			
expressAM	next working day by 12 noon	1 Business Day	£9.90 before VAT

The 'express24' option is highlighted with a red box and includes an 'Extra Services' button.

13. Tap the desired extra service.

← Extra Services

You'll need to drop off this parcel unless you choose **collection** below. Find your nearest drop off depot or post office. Depot and post office hours vary — see the Parcelforce website for details.

Additional Compensation

Saturday Delivery

Collection

express24

Total: £10.44  
(Including VAT)

Apply

14. Tap **Apply** to confirm the extra services.

15. Tap **Label Options** to add a memo onto the label. Enter further information about your parcel, if prompted. When complete, tap **Continue**. Alternatively, tap **Print** to print the label.

Carrier	Mail Class	Delivery	Price
Royal Mail	<b>2nd Class</b> Delivery in two to three working days for less urgent mail	2-3 Business Days	£2.95 VAT exempt
Royal Mail	<b>1st Class</b> Next-day delivery aim for letters and parcels	1-2 Business Days	£3.58 VAT exempt
Royal Mail	<b>Signed for 2nd Class</b> With a signature on delivery for peace of mind	2-3 Business Days	£3.95 VAT exempt
Royal Mail	<b>Signed for 1st Class</b> Signature on delivery and next-day delivery aim	1-2 Business Days	£4.58 VAT exempt

Sender: PITNEY BOWES LTD  
Recipient: alan robinson  
Package Type: custom  
Services: 1st Class  
Total: £3.58 (VAT Exempt)

**Label Options**

Format: Roll - 4 x 6 Print Sample

Memo (will print on label)

Print

Always show label options before printing

Reid Pk  
37 Executive Dr  
Danbury CT, 06810-4147

Pitney Bowes  
37 Executive Dr  
Danbury CT, 06810-4148

16. Tap **Print**.
17. The carrier screen reappears. You can now print another label.

## Printing a shipping label from the Address Book

Print a shipping label from an address you have selected in the Address Book.

1. Tap **SendPro Apps** on the Home screen, then tap **Shipping Address Book** to open the Shipping Address Book app.
2. Find the address you want to use for your label.
3. Tap the address to open it.
4. Tap **Print shipping Label** at the bottom right side of the screen.
5. Follow the steps for printing a shipping label.

## Tracking a shipment

Use the Shipping History app to find a tracking number for a shipment.

1. Tap **SendPro Apps** on the Home screen, then tap **Shipping History** to open the Shipping History app.
2. Find the shipment you want to track in the list.
3. Enter the tracking number in the [Royal Mail](#) or [ParcelForce](#) website to track your shipment.

## Adding a new sender address for shipping labels

If you need to ship from more than one address, you can add additional sender addresses to the shipping address book.

1. Tap **SendPro Apps** on the Home screen, then tap **Shipping Address Book** to open the Shipping Address Book app.
2. Tap **Recipients** and select **Senders**.
3. Tap **+**.
4. Enter the sender information.
5. Tap **Save**.

## Editing the sender address for shipping labels

Edit a sender address by editing it in the shipping address book.

1. Tap **SendPro Apps** on the Home screen, then tap **Shipping Address Book** to open the Shipping Address Book app.

2. Tap **Recipients** and select **Senders**.
3. Select the address you want to edit.
4. Tap the **edit** icon.
5. Make your edits then tap **Update**. The address book appears.

## Reprinting a shipping label

If a shipping label does not print correctly, you can print it again.

1. Tap **SendPro Apps** on the Home screen, then tap **Shipping History** to open the Shipping History app.
2. All the shipping labels appear by date. The latest date appears first. The Date column shows the date you purchased the postage.
3. Find your label in the list.
4. Tap the label to open the details screen.
5. Tap **Reprint Label** twice.

## Getting a refund for a shipping label

Void a shipping label to cancel it. The funds will be re-credited to your Purchase Power account.

You have up to fourteen days after you print the label to void it.

1. Tap **SendPro Apps** on the Home screen, then tap **Shipping History** to open the Shipping History app.
2. All the shipping labels appear by date. The latest date appears first in the list.
3. Find your label in the list.
4. Tap the label to open the details screen.
5. Tap **Void Label**.
6. Tap the tick box to confirm you accept the terms and conditions.
7. Tap **Continue**.
8. Press **back** twice to return to the Home screen.

## What are shipping Cost Accounts?

Use Cost Accounts to charge back costs for printing shipping labels. This help you keep track of how much each department is spending.

When you print a shipping label you can allocate a shipping cost account to that label.



Tap **SendPro Apps** on the Home screen, then tap **Cost Accounts** to open the Cost Accounts app to view all your cost accounts.

## Turning cost accounts on or off for shipping labels

Enable shipping cost accounts to keep a record of how much you are spending on shipping labels.

1. Tap **SendPro Apps** on the Home screen, then tap **Shipping Cost Accounts** to open the Shipping Cost Accounts app.
2. Tap the **Preferences** icon.



3. Tap the slider in the upper right so that it turns blue and displays **ON**.
  - Tap the tick box for **Require cost account for all shipments**. This makes your device allocate a shipping cost account to every shipping label.
4. Tap the slider in the upper right so that it turns grey to turn shipping cost accounts off.
5. Tap **Apply** to continue.

You must add at least one shipping cost account in order to use this feature.

## Adding a shipping label cost account

Add shipping Cost Accounts to record shipping label usage by department.

1. Tap **SendPro Apps** on the Home screen, then tap **Cost Accounts** to open the Shipping Cost Accounts app.
2. Tap **+** in the upper left corner of the shipping Cost Accounts screen.

3. Enter the account name, up to 20 characters. Tap **Enter** when done.

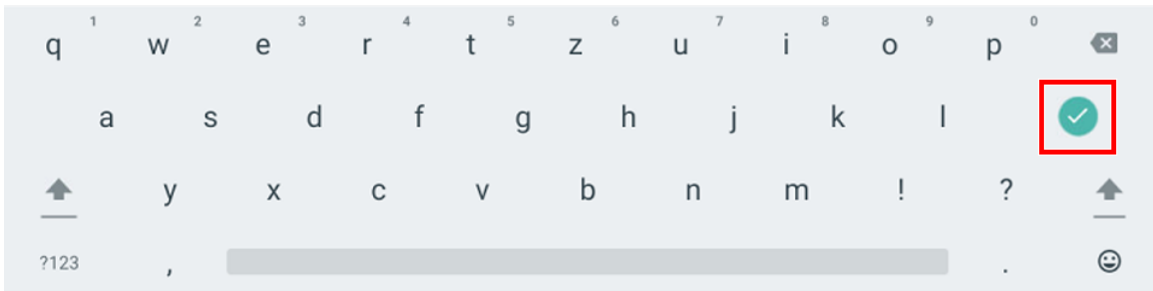

You can use lower case letters, upper case letters, numerals and special characters for the account name. Acceptable special characters include:

- - hyphen
- \_ dash
- ' single quote
- @ at sign
- . Full stop
- and optional description.

4. (Optional) Enter a description of the account up to 200 characters.
5. Tap **Enter** when done. You can use the same types of characters as for the account name.

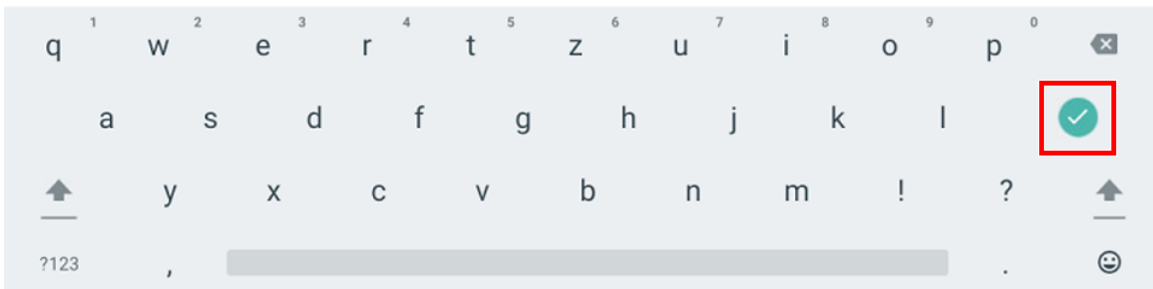

6. Tap **Active** or **Inactive**. Your selection should be whichever is appropriate for this account.
7. Tap **Make this my default Cost Account** to make this cost account automatically used for all shipping labels.
8. Tap **Add Account**.

## Modifying a shipping labels cost account

Modify a shipping cost account to activate or deactivate a cost account, set a default cost account, or modify the description.

You cannot delete an existing shipping cost account.

1. Tap **SendPro Apps** on the Home screen, then tap **Shipping Cost Accounts** to open the Shipping Cost Accounts app.

2. Tap the **Edit** icon for the shipping cost account you want to modify.



3. Tap the **Active** or **Inactive** option as required. Tap the **back arrow** to close the keyboard.
4. Tap the tick box for **Make this my default Cost Account** to make this account the default.
5. Tap the Description field to change the description.
6. Tap **Update** when done with all your changes.

## Adding a shipping labels preset

Add presets to store commonly-used parcel information. Presets are ideal for repeat parcels that use the same attributes such as weight, dimensions, carrier and class services.

You can add up to eight presets.

1. Once you print a label it appears in the Recents screen of the Parcel Shipping app.
2. Tap the **star** on the label you have printed.

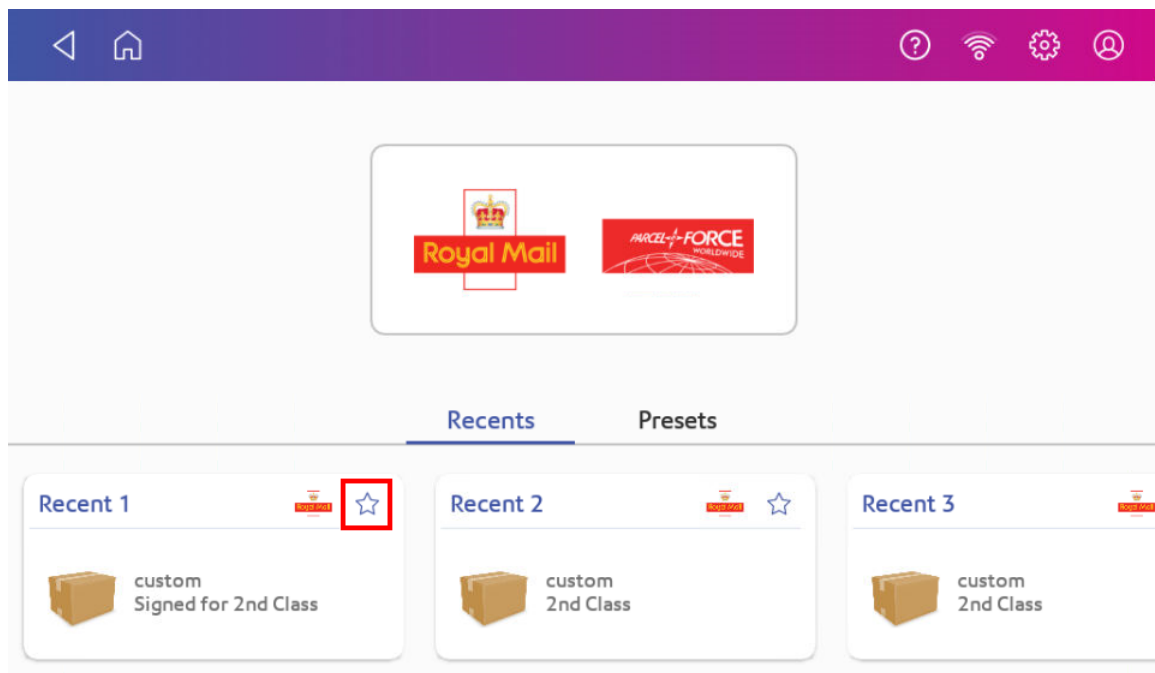

3. Enter the name of the preset in the **Name Preset** field.
4. Tap the **green tick**.
5. Tap **Save**.

## Setting a transaction limit for shipping labels

You can prevent shipping labels printing over a certain amount by setting a transaction limit.

You must log in as an Administrator to use this feature.

1. Tap **Settings**.



2. Tap **Label Options** in Shipping Settings.
3. Tap **Admin Option**.
4. Tap the **Set a maximum transaction limit for all users** tick box.
5. Enter an amount above £0.10p
6. Tap **Apply**.
7. Tap the back arrow to return to the Home screen.

## Setting the label options for shipping labels

Enable the label options setting to view the label options screen while printing a shipping label.

1. Tap **Settings**.



2. Tap **Label Options** in Shipping Settings.
3. Tap the **Always show label options screen before printing** tick box.
4. Tap the **back arrow** to return to the previous screen.

## Emailing tracking numbers for shipping labels

Email a tracking number for each new shipping label automatically.

1. Tap **Settings**.



2. Tap **Automated Emails** in Shipping Settings.

3. Tap **Email Notifications**.
4. Tap the **Send tracking emails to recipients** and **Send tracking emails to myself (or the sender)** tick boxes, as desired.
5. (Optional) Enter the subject in the Customize the email subject line field.
6. Tap the **back arrow** to return to the previous screen.

## Use SendPro Online to perform these tasks

You need to perform the following Parcel Shipping tasks using SendPro Online instead of your SendPro C, SendPro+ device.

Using a browser on your PC, go to <https://login.pitneybowes.com/sendpro>. You can use your SendPro C, SendPro+ device user ID and password to sign in to SendPro Online. You can also sign in to your PB account and go to SendPro Online from there.

### Importing and exporting

- Importing multiple Parcel Shipping addresses in SendPro Online and on the SendPro C, SendPro+
- Exporting Parcel Shipping addresses in SendPro Online and on the SendPro C, SendPro+
- Exporting Parcel Shipping history in SendPro Online and on the SendPro C, SendPro+

### Cost accounting

- Importing Cost Accounts in SendPro Online and on the SendPro C, SendPro+
- Exporting Cost Accounts in SendPro Online and on the SendPro C, SendPro+

### Presets

- Modifying Presets in SendPro Online and on the SendPro C, SendPro+
- Deleting Presets in SendPro Online and on the SendPro C, SendPro+

### Managing a multi-user subscription

- Managing Users in SendPro Online and on the SendPro C, SendPro+ (requires a multi-user subscription)
- Inviting Users in SendPro Online and on the SendPro C, SendPro+ (requires a multi-user subscription)
- Viewing Multi-Locations in SendPro Online and on the SendPro C, SendPro+ (requires a multi-user subscription)

## Sending post by First Class

Send your letters and small parcels by First Class post. First Class can be an economical way to send your post.

1. Tap **Envelope Printing** on the Home screen.
2. Tap **Account** and select an account.
3. Tap **Class**.
4. Tap **Start Over** to show a list of all the available classes.
5. Tap **Royal Mail First Class**.
6. Tap **Letter**.
7. Tap **Apply**.
8. Place the envelope on the scale. The weight appears.
9. Insert the envelope into the device. The device prints the postage.

## Sending a large First Class envelope

Send your large letters by First Class post. First Class can be an economical way to send your post.

1. Tap **Envelope Printing** on the Home screen.
2. Tap **Account** and select an account.
3. Tap **Class**.
4. Tap **Start Over** to show a list of all the available classes.
5. Tap **Royal Mail First Class**.
6. Tap **Large Letter**.
7. Tap **Apply**.
8. Place the envelope on the scale. The weight appears.
9. Insert the envelope into the device. The device prints the postage.

## Sending an international letter

Use this process if you need to send mail from the United Kingdom to a different country.

1. Tap **Envelope Printing** on the Home screen.
2. Tap **Account** and select an account.
3. Tap **Class**.
4. Tap **Start Over** to show a list of all the available classes.
5. Tap **International**.

6. Tap **Standard**.
7. Select the size of the mail (Letters, Large Letters, Small Parcels, Printed Papers).
8. Tap in the **Country** field and use the keypad to enter the destination country.
9. Tap **Apply**.
10. Place the envelope on the scale. The weight appears.
11. Insert the envelope into the device. The device prints the postage.

## Sending post using Special Delivery rates

If you use Special Delivery rates, your device now prints a tracking barcode directly onto the mailpiece. You can then track your mail via the [Royal Mail](#) website.

You can obtain a list of the tracking numbers printed by viewing or emailing a report on your device. You can also generate a report by using Inview™, within [Your Account](#).

To print Special Delivery rates and view printed tracking numbers, follow the steps in each section below.

- [Printing Special Delivery rates](#)
- [Viewing printed Special Delivery tracking numbers](#)

### Printing Special Delivery Rates

1. Tap **Envelope Printing** on the Home screen.
2. Tap **Class**.

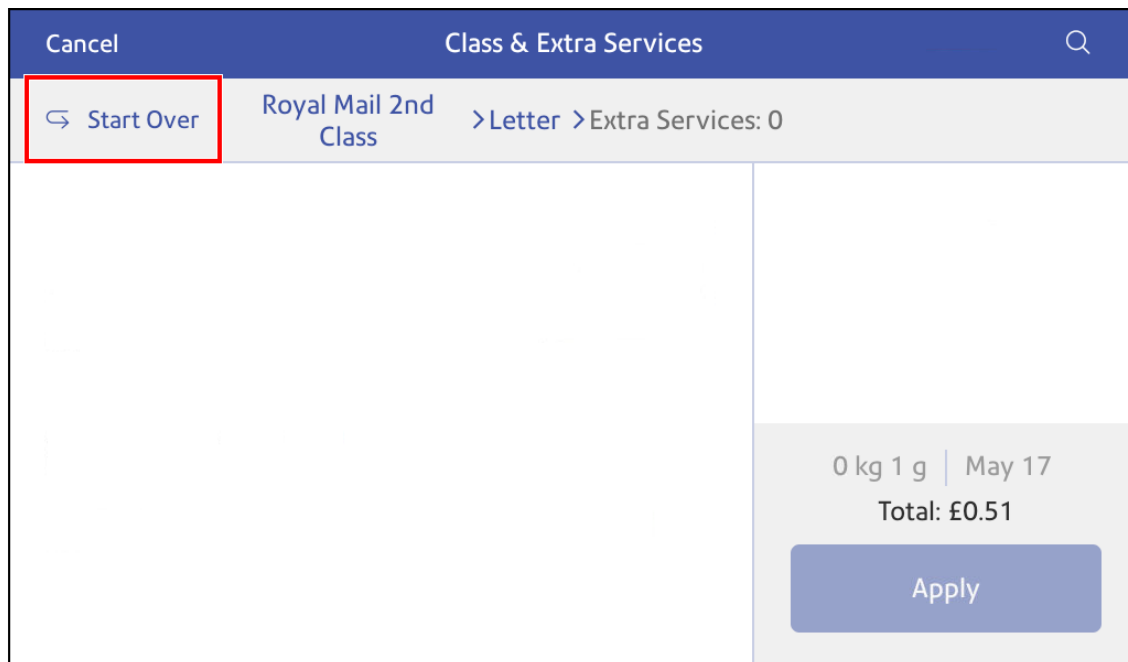
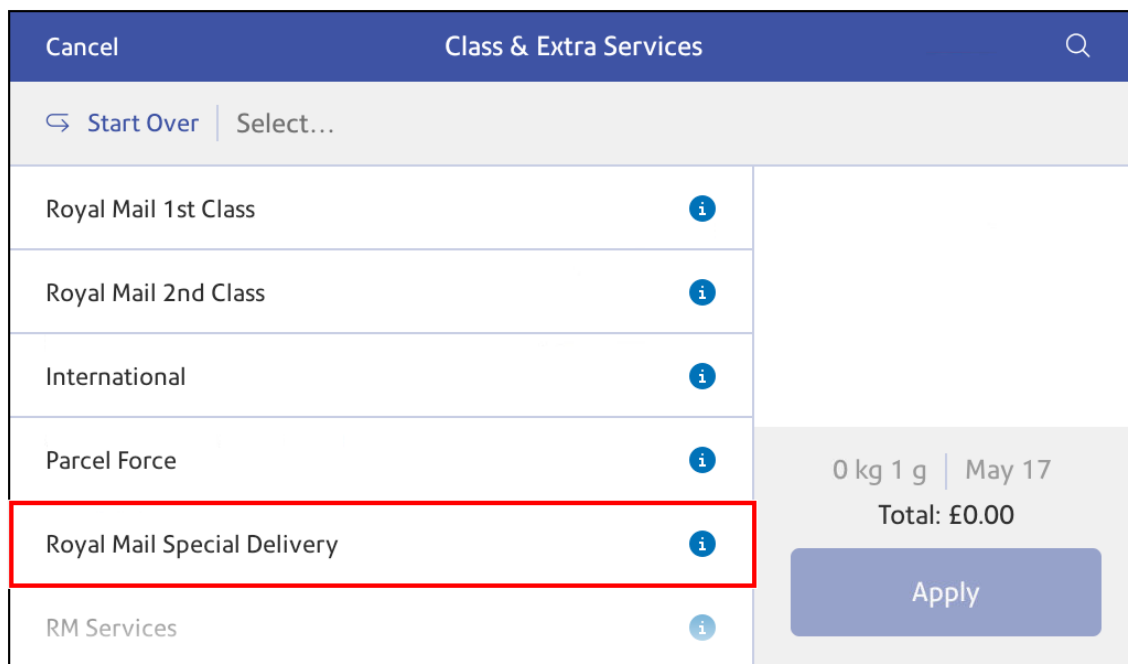
3. Tap **Start Over**.4. Tap **Royal Mail Special Delivery**.



5. Tap the desired Special Delivery class and compensation value.

The screenshot shows the 'Class & Extra Services' screen. At the top, there is a blue header with 'Cancel' on the left, 'Class & Extra Services' in the center, and a search icon on the right. Below the header is a grey bar with a back arrow, 'Start Over', a vertical bar, 'Royal Mail Special Delivery', a right arrow, and 'Select...'. The main content area is a list of six items, each with a time and a compensation value, and an information icon (i) on the right. The list is highlighted with a red box. The items are: 9.00 am (£50), 9.00 am (£1000), 9.00 am (£2500), 1.00 pm (£500), 1.00 pm (£1000), and 1.00 pm (£2500). To the right of the list, there is a grey box with '0 kg 3 g | May 23' and 'Total: £0.00'. Below this is a blue 'Apply' button.

Time	Compensation Value	Info Icon
9.00 am	£50	i
9.00 am	£1000	i
9.00 am	£2500	i
1.00 pm	£500	i
1.00 pm	£1000	i
1.00 pm	£2500	i

6. Tap the type of Special Delivery service you need.

The screenshot shows the 'Class & Extra Services' screen. At the top, there is a blue header with 'Cancel' on the left, 'Class & Extra Services' in the center, and a search icon on the right. Below the header is a grey bar with a back arrow, 'Start Over', a vertical bar, 'Royal Mail Special Delivery', a right arrow, '> 1.00 pm (£500)', a right arrow, and 'Select...'. The main content area is a list of four items, each with a service type and an information icon (i) on the right. The list is highlighted with a red box. The items are: Standard, Conseq Loss compensation only, Saturday Service, and Jersey/Guernsey. To the right of the list, there is a grey box with '0 kg 1 g | May 17' and 'Total: £0.00'. Below this is a blue 'Apply' button.

Service Type	Info Icon
Standard	i
Conseq Loss compensation only	i
Saturday Service	i
Jersey/Guernsey	i

7. If prompted, tap **Apply** or alternatively select any required extra fees or services.

8. Tap **Apply** to confirm. You return to the Envelope Printing app. A preview of the tracking number appears. You can now frank your mail.

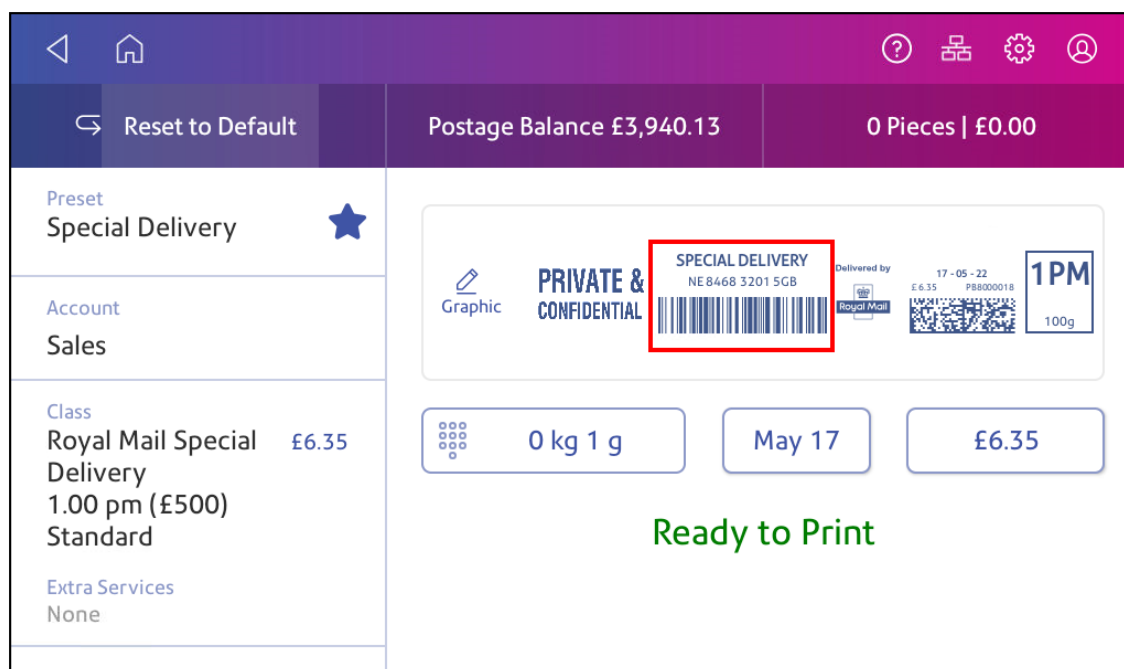

**Important:** You can only print a custom graphic or a custom text message along with a Special Delivery tracking barcode.

## Viewing printed Special Delivery tracking numbers

1. Tap **SendPro Apps** on the Home screen.
2. Tap **Manage Accounts**.
3. If necessary, tap **Got It** at the **No Sync Required** prompt.

#### 4. Tap **Reports**.

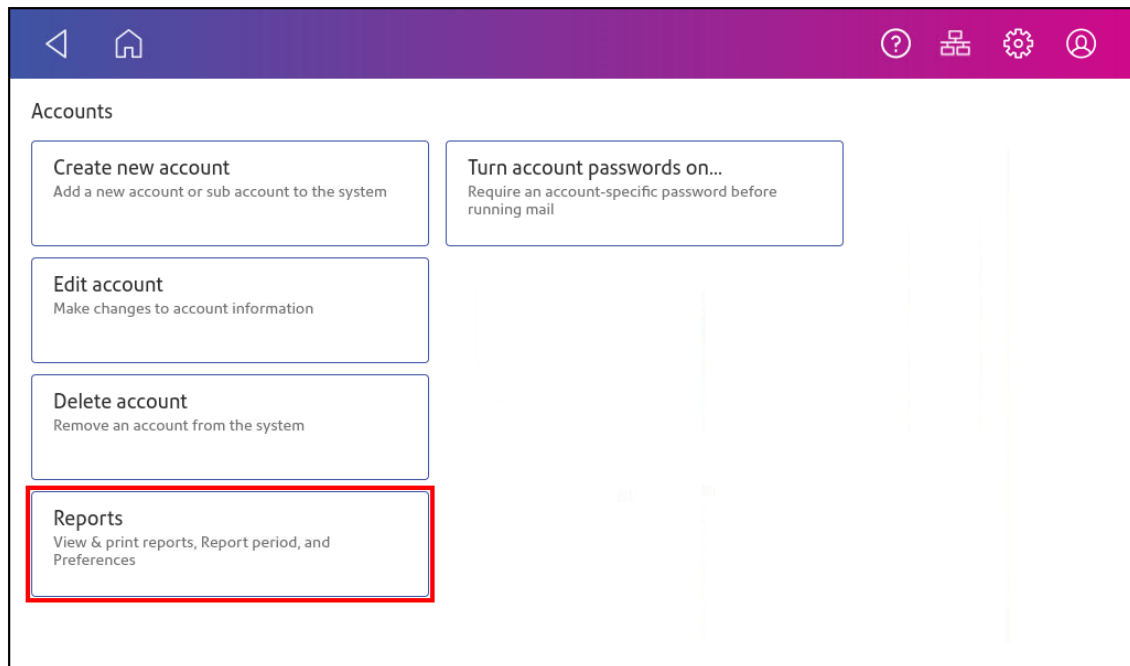

#### 5. Tap **View & print reports**.

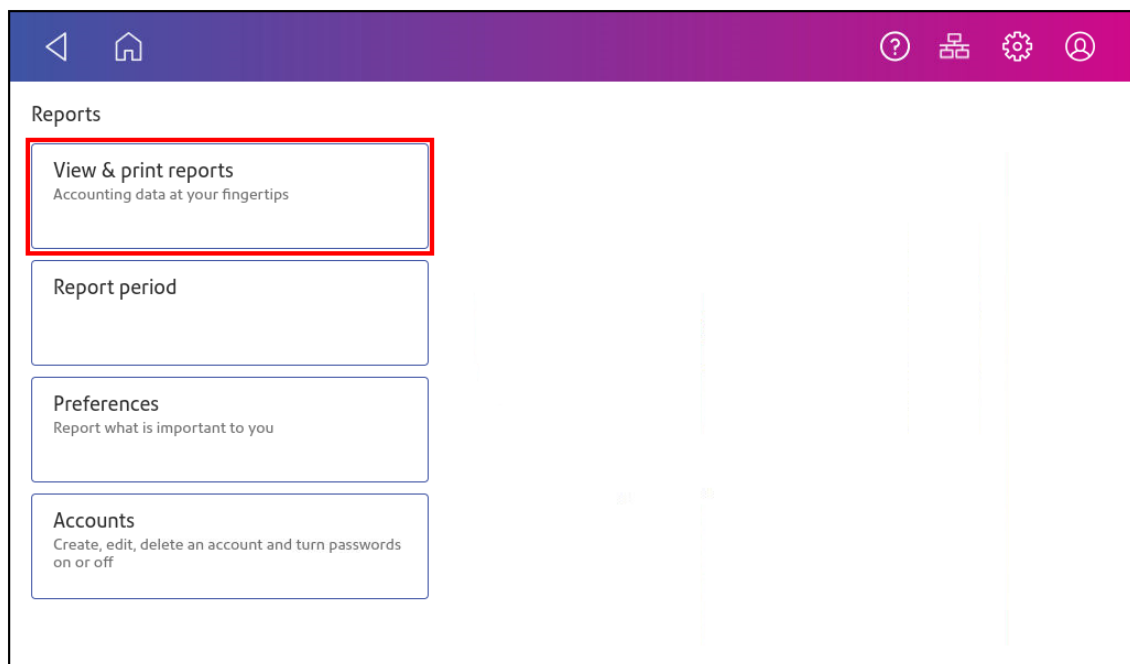

6. Tap the **UK Trackable Products** report. You may need to scroll to locate this report.

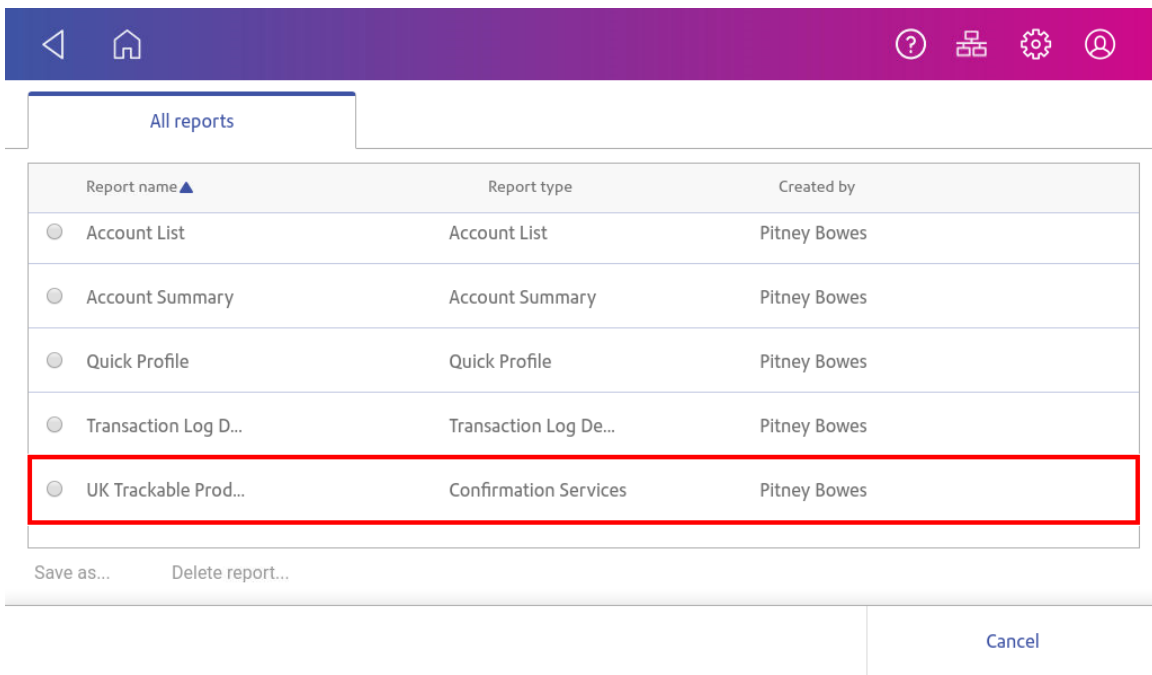

7. Tap **Next**, then set the time period you want the report to provide.

8. Tap **View report** to view the report information on your device.

Tracking Number	Meter (PSD)	Date	Time	Class/Compensation	Total Postage + Fees	Recipient PostCode
DF550504075GB	8000018	19-MAY-22	11:52:10	RM Signed For Letter	£2.18	
DF550504089GB	8000018	19-MAY-22	11:52:13	RM Signed For Letter	£2.18	
DF550504092GB	8000018	19-MAY-22	11:52:15	RM Signed For Letter	£2.18	
DF550504101GB	8000018	19-MAY-22	11:52:18	RM Signed For Letter	£2.18	
MS224746614GB	8000018	04-MAY-22	14:37:07	9.00 am (£50) Standard	£22.45	
MS224746628GB	8000018	05-MAY-22	10:44:23	9.00 am (£2500) Standard	£28.15	
MS224746631GB	8000018	05-MAY-22	10:44:54	9.00 am (£2500) Standard	£28.15	
MS224746645GB	8000018	05-MAY-22	10:55:32	9.00 am (£50) Standard	£22.45	
MS224746659GB	8000018	05-MAY-22	10:55:35	9.00 am (£50) Standard	£22.45	
MS224746662GB	8000018	05-MAY-22	10:55:37	9.00 am (£50) Standard	£22.45	
MS224746676GB	8000018	05-MAY-22	10:55:40	9.00 am (£50) Standard	£22.45	

Actions ▲ Back Done

9. Alternatively, tap **Actions** then **Email Report** to email the report.

## Sending post using Signed For rates

If you use Signed For rates, your device now prints a tracking barcode directly onto the mailpiece. You can then track your mail via the [Royal Mail](#) website.

You can obtain a list of the tracking numbers printed by viewing or emailing a report on your device. You can also generate a report by using Inview™, within [Your Account](#).

To print Signed For rates and view printed tracking numbers, follow the steps in each section below.

- [Printing Signed For rates](#)
- [Viewing printed Signed For tracking numbers](#)

### Printing Signed For Rates

1. Tap **Envelope Printing** on the Home screen.
2. Tap **Class**.
3. Tap **Start Over**.

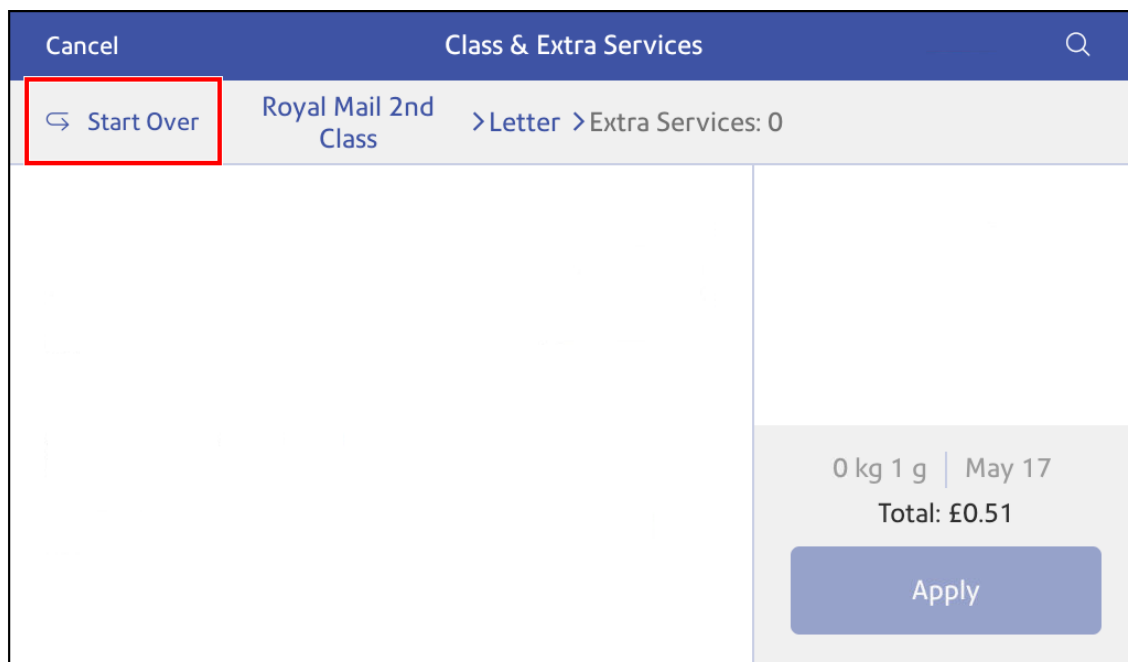

4. Tap **Royal Mail 1st Class** or **Royal Mail 2nd Class**.

Cancel		Class & Extra Services		Q
↶ Start Over		Select...		
Royal Mail 1st Class	i	0 kg 1 g   May 17 Total: £0.00 Apply		
Royal Mail 2nd Class	i			
International	i			
Parcel Force	i			
Royal Mail Special Delivery	i			
RM Services	i			

5. Tap **RM Signed For**.

Cancel		Class & Extra Services		Q
↶ Start Over		Royal Mail 1st Class	>Select...	
Letter	i	0 kg 1 g   May 19 Total: £0.00 Apply		
Large Letter	i			
Small Parcel	i			
Medium Parcel	i			
RM Signed For	i			
Pre-Pay Reply Letter	i			

6. Tap the size of the mail you are sending.

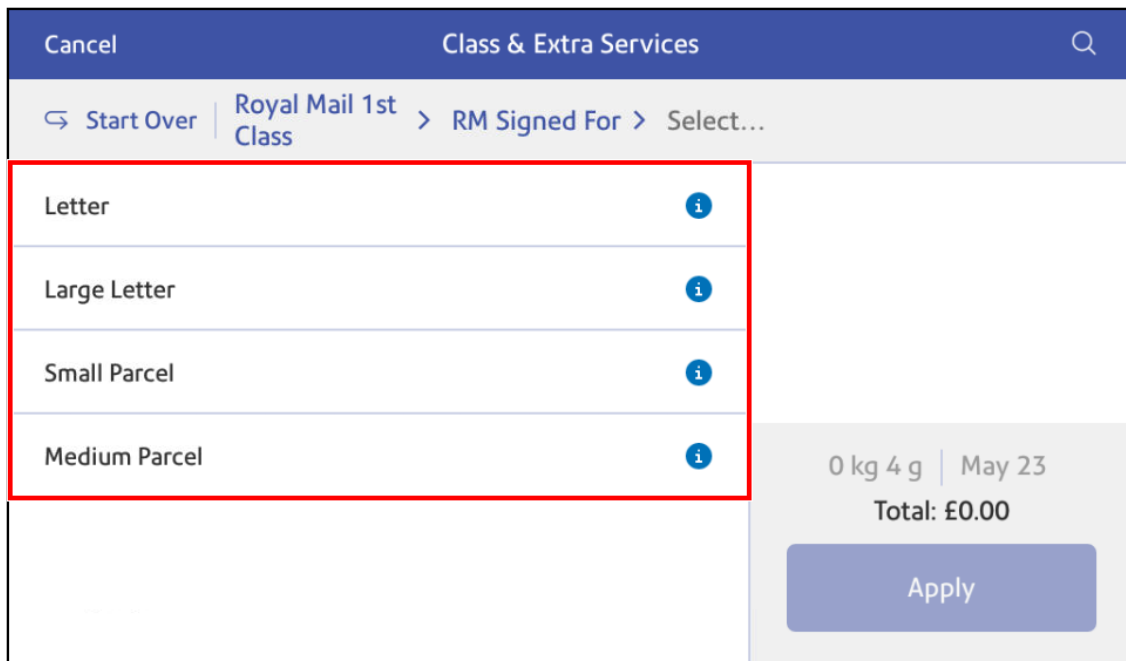

7. Tap **Apply**. You return to the Envelope Printing app. A preview of the tracking number appears. You can now frank your mail.

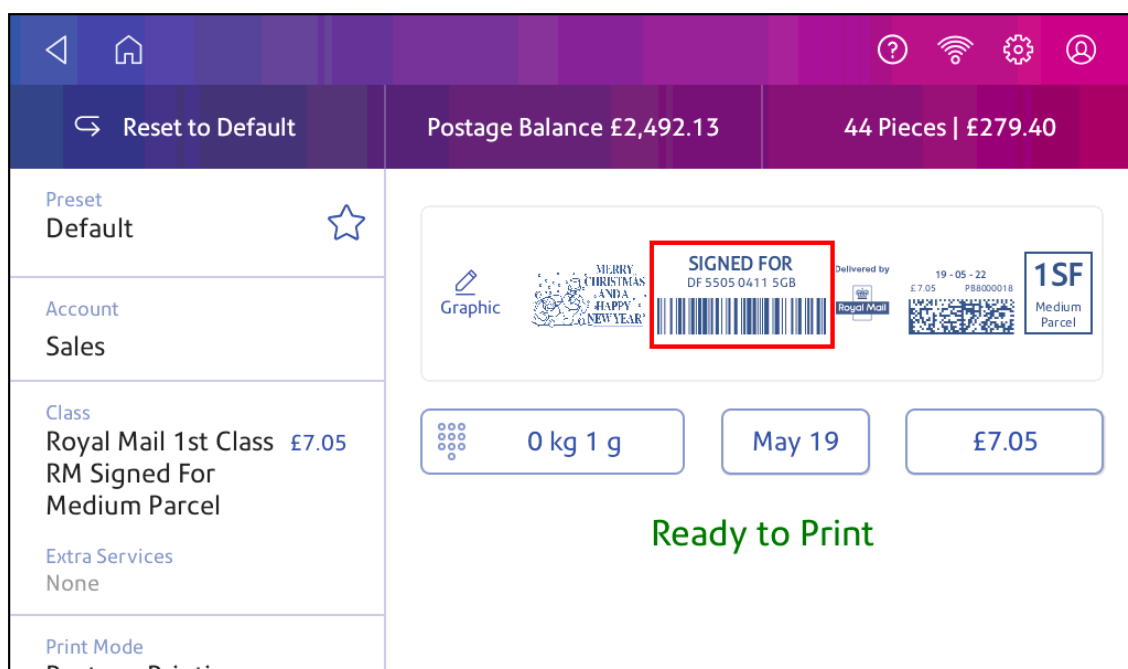

**Important:** You can only print a custom graphic or a custom text message along with a Signed For tracking barcode.

## Viewing printed Signed For tracking numbers

1. Tap **SendPro Apps** on the Home screen.
2. Tap **Manage Accounts**.
3. If necessary, tap **Got It** at the **No Sync Required** prompt.
4. Tap **Reports**.

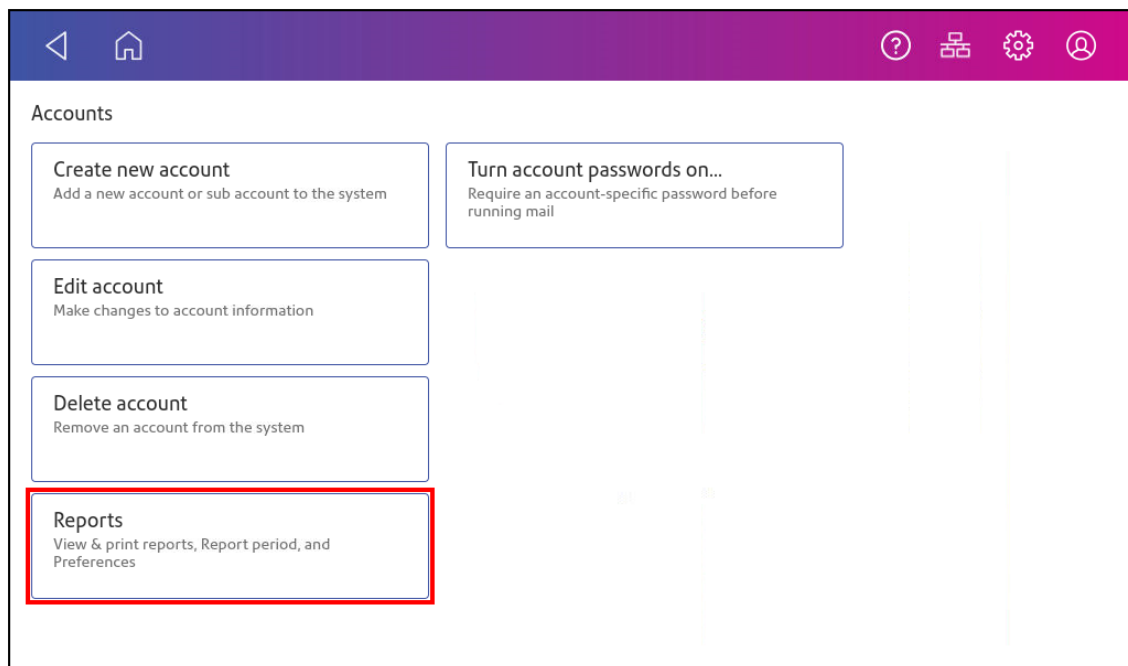

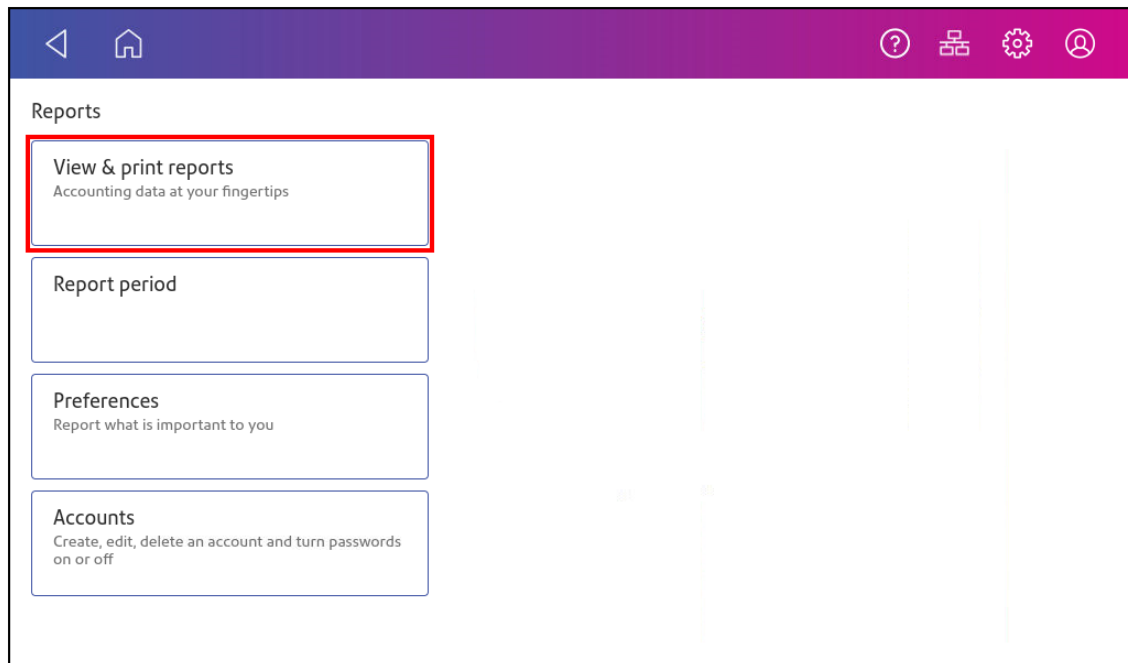
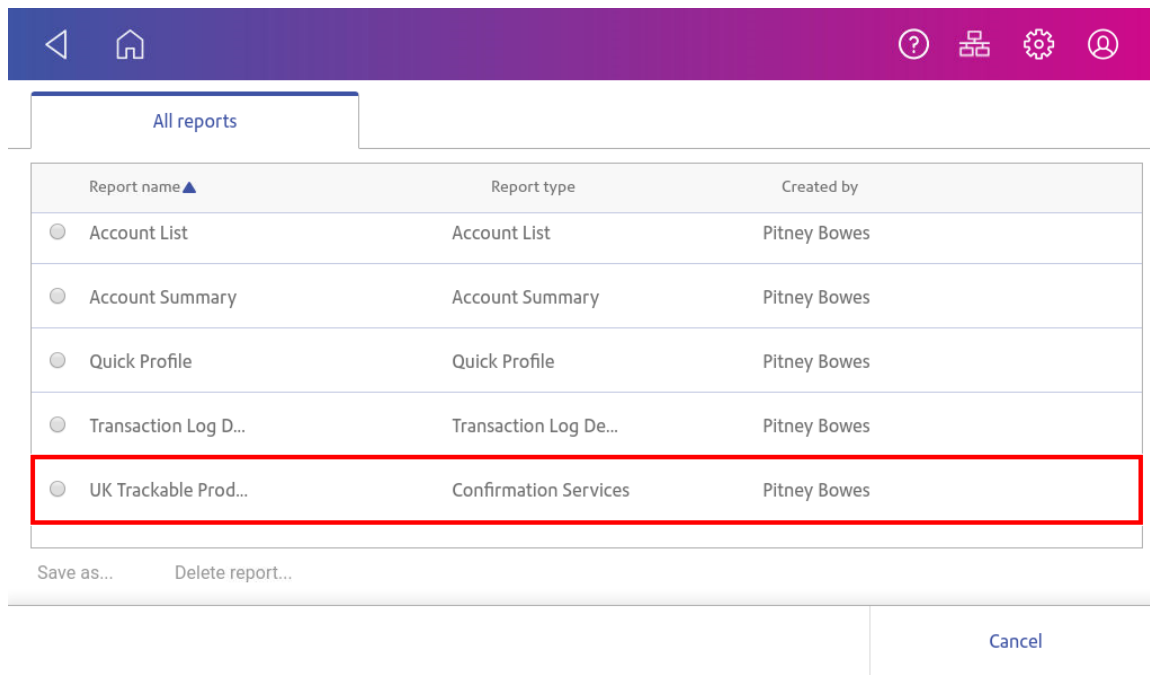

5. Tap **View & print reports**.6. Tap the **UK Trackable Products** report. You may need to scroll to locate this report.7. Tap **Next**, then set the time period you want the report to provide.

8. Tap **View report** to view the report information on your device.

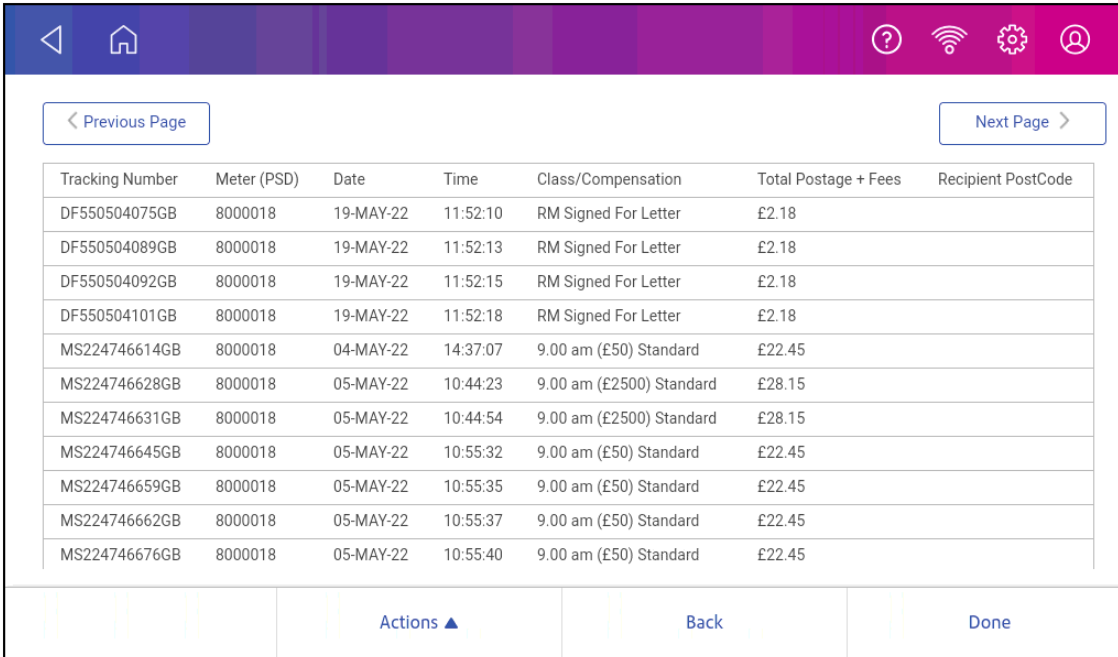

Tracking Number	Meter (PSD)	Date	Time	Class/Compensation	Total Postage + Fees	Recipient PostCode
DF550504075GB	8000018	19-MAY-22	11:52:10	RM Signed For Letter	£2.18	
DF550504089GB	8000018	19-MAY-22	11:52:13	RM Signed For Letter	£2.18	
DF550504092GB	8000018	19-MAY-22	11:52:15	RM Signed For Letter	£2.18	
DF550504101GB	8000018	19-MAY-22	11:52:18	RM Signed For Letter	£2.18	
MS224746614GB	8000018	04-MAY-22	14:37:07	9.00 am (£50) Standard	£22.45	
MS224746628GB	8000018	05-MAY-22	10:44:23	9.00 am (£2500) Standard	£28.15	
MS224746631GB	8000018	05-MAY-22	10:44:54	9.00 am (£2500) Standard	£28.15	
MS224746645GB	8000018	05-MAY-22	10:55:32	9.00 am (£50) Standard	£22.45	
MS224746659GB	8000018	05-MAY-22	10:55:35	9.00 am (£50) Standard	£22.45	
MS224746662GB	8000018	05-MAY-22	10:55:37	9.00 am (£50) Standard	£22.45	
MS224746676GB	8000018	05-MAY-22	10:55:40	9.00 am (£50) Standard	£22.45	

9. Alternatively, tap **Actions** then **Email Report** to email the report.

## Viewing and exporting Special Delivery and Signed For tracking numbers in Inview

You can view a report showing Special Delivery and Signed For tracking numbers in Inview. You can also export the report in a xls, csv or PDF format. You can use this report to add additional information such as a recipient post code.

**Important:** You must sync the transaction data from your device before you view and export the report within Inview.

- [Syncing the transaction data](#)
- [Viewing and exporting reports in Inview](#)

### Syncing the transaction data

1. Tap **Settings**.



2. Tap **Sync Transaction Data**.
3. Tap **Got It** at the **Transaction Data Sent** or **No Sync Required** prompt.

## Viewing and exporting reports in Inview

1. [Sign in](#) to the Pitney Bowes Your Account online portal.
2. Scroll down to **Inview Total Meter Reporting**, then click **Launch**. Alternatively, from the Your Products drop-down in the top navigation bar, select **Inview Analytics**.
3. Click **Meter Reports**.
4. If necessary, select your franking machine from the **Choose Meters edit/view** link.

**INVIEW™ Total Meter Reporting** Welcome | YOUR ACCOUNT | Sign out

Postage Reports Meter Reports Account Reports My Reports Preferences

Search

Support

Choose Report: Meter Balance [About this report](#)

Choose Meters: All Meters (98) selected [edit/view](#)

Choose Time Period: [Calendar icon]

Run Save Setting

**Meter Balance Report** ⚠ Meter data incomplete for 80 meter(s) [Fix this](#) Export to... Print Help

**Meter Balances**  
01 April 2022 to 30 April 2022

Summary  Details

Location	Start Funds Available	Refill/Refund	Postage Used	End Funds Available
ALSTON,	£7,350,160	£250,000	£0,780	£7,599,380
BRADFORD,	£485,490	£0,000	£41,180	£444,310
HARLOW,	£10,086,540	£21,650,000	£8,608,100	£23,128,440
LONDON	£38,649,670	£478,889,450	£420,672,710	£96,866,410
London2	£68,330,770	£50,000	£59,342,220	£9,038,550
<b>Totals</b>				<b>£137,077,090</b>

[View Meter Report Criteria](#)

5. Click **UK Trackable Products** from the **Choose Report** drop-down.

The screenshot shows the INVIEW Total Meter Reporting dashboard. The 'Choose Report' dropdown menu is open, displaying 'UK Trackable Products' and 'About this report'. The 'Run' button is visible, and the 'Choose Time Period' is set to 'Custom' from 19/05/2022 to 19/05/2022. Below the dropdown, a table of tracking data is visible.

Tracking Number	Meter (PSD)	Date	Time	Class/Compensation	Total Postage + Fees	Recipient Postcode
DF550504027GB	8000018	19-MAY-22	11:29:37	RM Signed For Letter	£2.18	
DF550504035GB	8000018	19-MAY-22	11:29:40	RM Signed For Letter	£2.18	
DF550504044GB	8000018	19-MAY-22	11:29:42	RM Signed For Letter	£2.18	
DF550504058GB	8000018	19-MAY-22	11:29:44	RM Signed For Letter	£2.18	
MS225141035GB	8000018	19-MAY-22	11:29:06	9.00 am (£50) Standard	£22.45	
MS225141044GB	8000018	19-MAY-22	11:29:09	9.00 am (£50) Standard	£22.45	
MS225141058GB	8000018	19-MAY-22	11:29:11	9.00 am (£50) Standard	£22.45	
MS225141061GB	8000018	19-MAY-22	11:29:13	9.00 am (£50) Standard	£22.45	
MS225141075GB	8000018	19-MAY-22	11:29:16	9.00 am (£50) Standard	£22.45	

6. Select the dates you want your report to show in the **Choose Time Period** calendars.

The screenshot shows the INVIEW Total Meter Reporting dashboard. The 'Choose Time Period' dropdown menu is open, displaying 'Custom' and the date range '19/05/2022 to 19/05/2022'. The 'Run' button is visible. Below the dropdown, a table of tracking data is visible.

Tracking Number	Meter (PSD)	Date	Time	Class/Compensation	Total Postage + Fees
DF550504061GB	8000018	19-MAY-22	11:52:07	RM Signed For Letter	£2.18
DF550504075GB	8000018	19-MAY-22	11:52:10	RM Signed For Letter	£2.18
DF550504089GB	8000018	19-MAY-22	11:52:13	RM Signed For Letter	£2.18
DF550504092GB	8000018	19-MAY-22	11:52:15	RM Signed For Letter	£2.18
DF550504101GB	8000018	19-MAY-22	11:52:18	RM Signed For Letter	£2.18
MS225141035GB	8000018	19-MAY-22	11:29:06	9.00 am (£50) Standard	£22.45
MS225141044GB	8000018	19-MAY-22	11:29:09	9.00 am (£50) Standard	£22.45
MS225141058GB	8000018	19-MAY-22	11:29:11	9.00 am (£50) Standard	£22.45
MS225141061GB	8000018	19-MAY-22	11:29:13	9.00 am (£50) Standard	£22.45
MS225141075GB	8000018	19-MAY-22	11:29:16	9.00 am (£50) Standard	£22.45

7. Click **Run**. You can now view the report.

The screenshot shows the INVIEW Total Meter Reporting dashboard. At the top, there's a navigation bar with 'Postage Reports', 'Meter Reports', 'Account Reports', 'My Reports', and 'Preferences'. Below this, there are filters for 'Choose Report' (UK Trackable Products), 'Choose Meters' (Custom (1) selected), and 'Choose Time Period' (Custom, 19/05/2022 to 19/05/2022). A 'Run' button is highlighted with a red box. Below the filters, there's a table titled 'UK Trackable Products Report' for the period '19 May 2022 to 19 May 2022'. The table has columns for product ID, meter ID, date, time, service, and cost.

Product ID	Meter ID	Date	Time	Service	Cost
DF550504061GB	8000018	19-MAY-22	11:52:07	RM Signed For Letter	£2.18
DF550504075GB	8000018	19-MAY-22	11:52:10	RM Signed For Letter	£2.18
DF550504089GB	8000018	19-MAY-22	11:52:13	RM Signed For Letter	£2.18
DF550504092GB	8000018	19-MAY-22	11:52:15	RM Signed For Letter	£2.18
DF550504101GB	8000018	19-MAY-22	11:52:18	RM Signed For Letter	£2.18
MS225141035GB	8000018	19-MAY-22	11:29:06	9.00 am (£50) Standard	£22.45
MS225141044GB	8000018	19-MAY-22	11:29:09	9.00 am (£50) Standard	£22.45
MS225141058GB	8000018	19-MAY-22	11:29:11	9.00 am (£50) Standard	£22.45
MS225141061GB	8000018	19-MAY-22	11:29:13	9.00 am (£50) Standard	£22.45
MS225141075GB	8000018	19-MAY-22	11:29:16	9.00 am (£50) Standard	£22.45

8. To export the report, click **Export to** and click **CSV**, **Excel** or **PDF**.

The screenshot shows the same INVIEW Total Meter Reporting dashboard as in the previous image. The 'Export to' dropdown menu is open, showing options for 'CSV', 'Excel', and 'PDF'. The 'Export to' button and the dropdown menu are highlighted with a red box. The table data is the same as in the previous image.

9. Click **OK** to include the report criteria.

# 7 - Address Management

## In this section

---

Using the Address Book .....	91
Adding new addresses to the Address Book .....	91
Searching addresses in the Address Book .....	91
Editing addresses in the Address Book .....	91
Deleting addresses from the Address Book .....	92

## Using the Address Book

The Address Book app allows you to add, edit, and delete addresses for everyone you ship to. Once you add an address to the Address Book app, you can select it when you print shipping labels.

To open the Address Book:

- Tap **SendPro Apps** on the Home screen, then tap **Address Book**.

## Adding new addresses to the Address Book

Once you add an address to the Address Book app, you can select it when you print shipping labels. The Address Book can hold up to 1000 addresses.

1. To open the Address Book:
  - Tap **SendPro Apps** on the Home screen, then tap **Address Book**.
2. Tap **Recipients** if the new address is a recipient. Alternatively, tap **Senders**.
3. Tap **+**.
4. Enter the address information.
5. Tap **Save** when done.

## Searching addresses in the Address Book

Use the search feature in the Address Book to quickly find an address. This feature is helpful if you have many addresses stored in your address book.

1. To open the Address Book:
  - Tap **SendPro Apps** on the Home screen, then tap **Address Book**.
2. Search for an address by typing a portion of the contact (name, company etc.) in the search field. The Address Book shows matching addresses.
3. Tap **Sort by** to sort the Address Book, then select how you wish to sort (name, company, city).

You can print a Parcel Shipping label once you find an address. Select the address, then tap **Print shipping label**.

## Editing addresses in the Address Book

Edit addresses in the Address Book when you want to change any of the information.

- To open the Address Book:
  - Tap **SendPro Apps** on the Home screen, then tap **Address Book**.
- Tap the address you want to edit.
- Tap **Edit**.

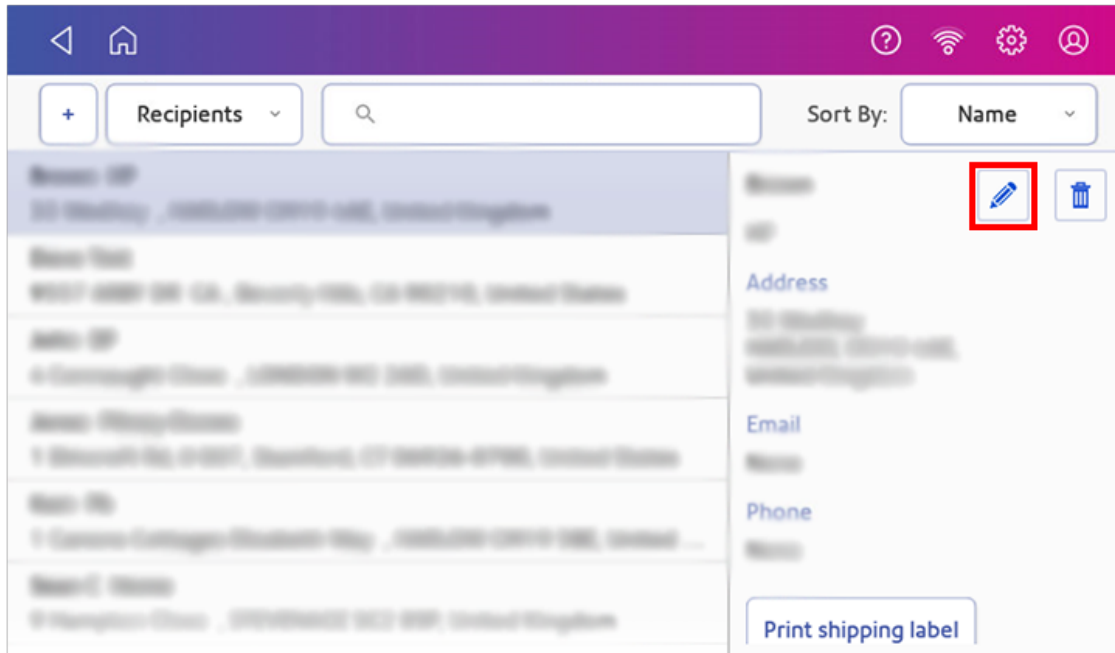

- Make your changes to the address information, then tap **Update**.

## Deleting addresses from the Address Book

You can delete addresses from the Address Book if you no longer use them. You cannot restore an address if you delete it.

- To open the Address Book:
  - Tap **SendPro Apps** on the Home screen, then tap **Address Book**.
- Select the address you want to delete.



3. Tap **Delete**.

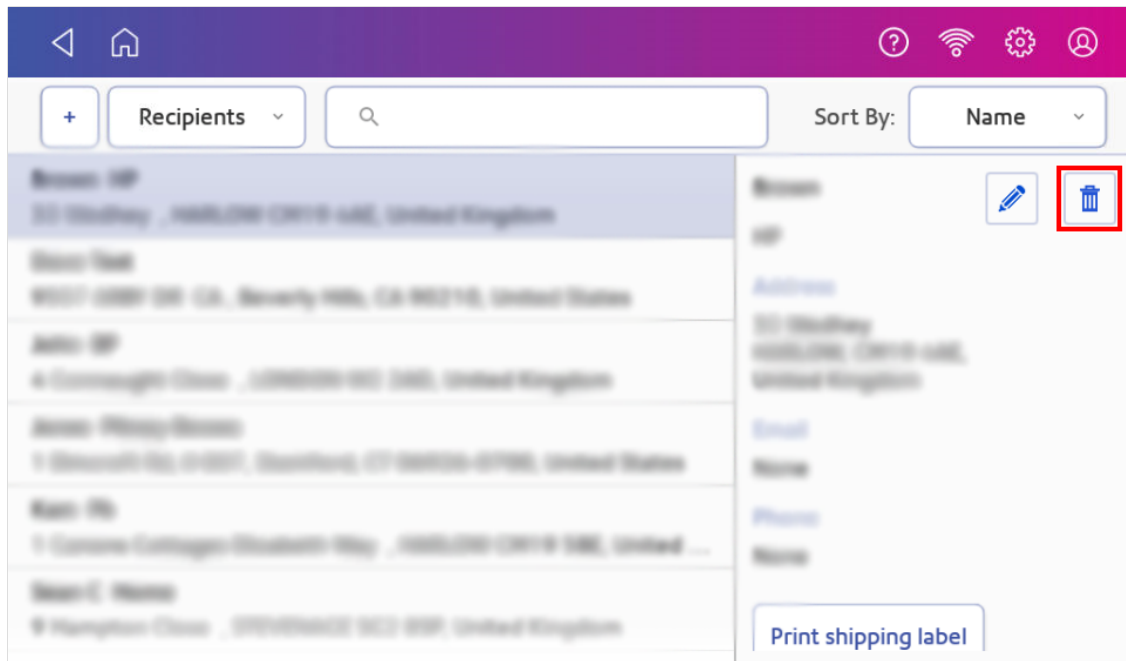

4. Tap **Delete** to confirm.

# 8 - Sealing

## In this section

Filling the moistener tank.....	95
Sealing envelopes when you print postage.....	95
Sealing envelopes without printing postage.....	97
Avoiding envelope sealing issues.....	98

## Filling the moistener tank

Your device will need refills of E-Z Seal® in order to seal envelopes. Follow these steps to fill the moistener tank.

1. Check the level of E-Z Seal® in your moistener tank **(1)**.

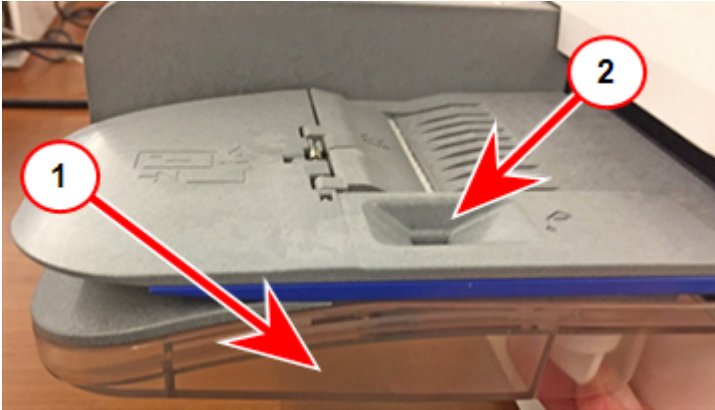

2. Add enough E-Z Seal® to bring the sealant level up to the bottom of the fill hole **(2)**. Do not overfill the tank.
3. If the tank is empty, allow 30 minutes for the moistener brush and wick to get completely wet.

## Sealing envelopes when you print postage

You can seal envelopes and print postage at the same time with your SendPro C, SendPro+.

1. Check the level of sealing solution in the moistener tank. Add more if required.
2. Slide the envelope flap under the edge of the feed deck so the moistener can wet the flap.

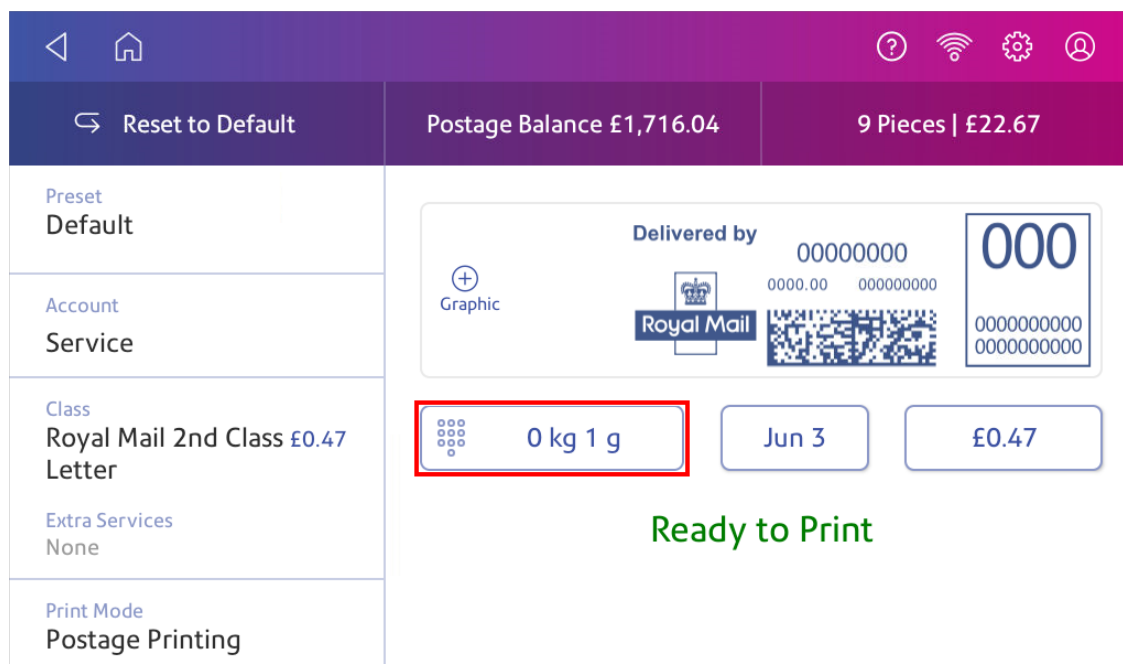

3. Tap **Envelope Printing** on the Home screen.
4. Tap **Account**, then select an account.

5. Tap **Weight**.

6. Tap **Scale**.
7. Place the envelope on the scale. You must do this before the next step or else **Apply** remains inactive.
8. Tap **Class** then select the class of mail you want.
9. Tap **Graphic** then select a graphic, if necessary.
10. Tap **Apply** to continue.
11. Insert the envelope into the device. The device prints the postage .

**Important:** If the moistener tank is full and your envelopes do not seal correctly, clean the moistener brush and wick.

## Sealing envelopes without printing postage

Use Seal Only mode to seal envelopes without printing anything.

1. Tap **Envelope Printing** on the Home screen.
2. Tap **Print Mode**. You may need to swipe up on the screen to see this option.
3. Select **Seal Only**.
4. Tap **Apply**.

5. Place your envelope face up, flap down into the feeder. Be sure to slide the envelope flap under the edge of the feed deck.



6. Insert the envelope into the device. The device seals the envelope.



## Avoiding envelope sealing issues

Prevent sealing issues by:

- Having enough sealant in the moistener tank.
- Placing the envelope correctly on the feed deck.
- Maintaining the wick or brush in the moistener.

1. Check the level of sealant in the moistener tank. Add more if required.

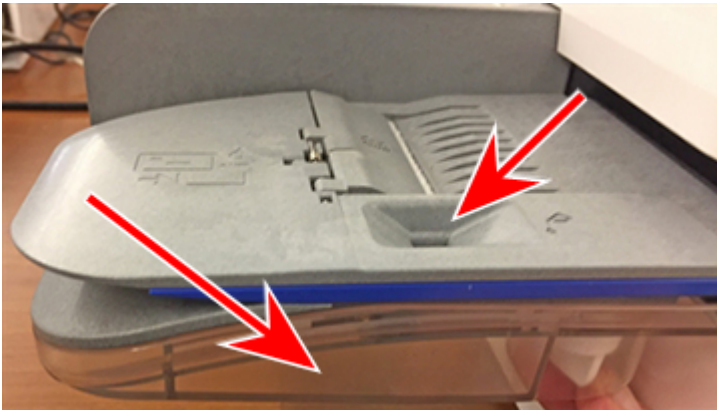

2. Slide the envelope flap under the edge of the feed deck when inserting an envelope. Otherwise, the moistener cannot wet the flap.

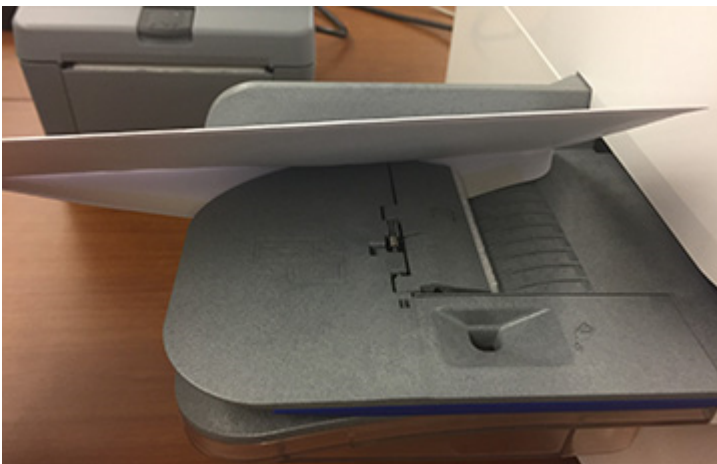

3. If the moistener tank is full, and your envelopes are still not sealing correctly, clean your moistener brush and wick.

# 9 - History and Reports

## In this section

Viewing a postage refill receipt for Envelope Printing.....	101
Viewing the total spent on printing postage.....	101
Printing a funds report.....	101
Running postage printing account reports.....	102
Setting the postage printing account report period.....	103
Setting the account report preferences.....	104
Emailing an account report.....	105



## Viewing a postage refill receipt for Envelope Printing

View receipts of previous postage refills by using the Print Refill Receipt or History and Reports apps.

**Important:** At this time, you can only view the report.

1. Tap **SendPro Apps** on the Home screen.
2. Tap **Print Refill Receipt**.
3. Tap **Refill History**.
4. Tap the receipt you want to view.
5. Tap **Cancel** then **Close** to return to the Home screen.

## Viewing the total spent on printing postage

View the total amount you have spent on postage and the total number of pieces printed.

1. Tap **Settings**.



2. Scroll down to the Envelope Printer Settings section.
3. Tap **Postage Refills**.
4. Tap **Advanced** to view the total amount of postage spent and the number of pieces printed.

## Printing a funds report

Print a funds report if you need a report showing the total number of mailpieces sent.

The funds report provides the following information about your device:

- **Used:** The total amount used over the lifetime of the device.
- **Available:** The amount currently available to print.
- **Total Pieces:** The total number of mailpieces run over the lifetime of the device.
- **Control Sum:** The control sum is the total of the amount used and available.
- **Batch Count:** The current Batch Count.
- **Batch Value:** The current Batch Total.
- **PBP Serial No:** The serial number of the device.
- The date and time the report was printed.

To print a funds report:

1. Tap **Envelope Printing** on the Home screen.
2. Tap the piece count in the upper right.
3. Tap **Print Report**.
4. Tap **SendPro C Envelope Printer**.
5. Insert an envelope into the device. The device prints the report.
6. Tap the **back arrow** to return to the Envelope Printing app.

## Running postage printing account reports

Run account reports to show how you spent your postage for a specific account or for all accounts over various time periods.

1. Tap **Envelope Printing** on the Home screen.
2. Tap **Account**.
3. Tap **Manage Accounts**.

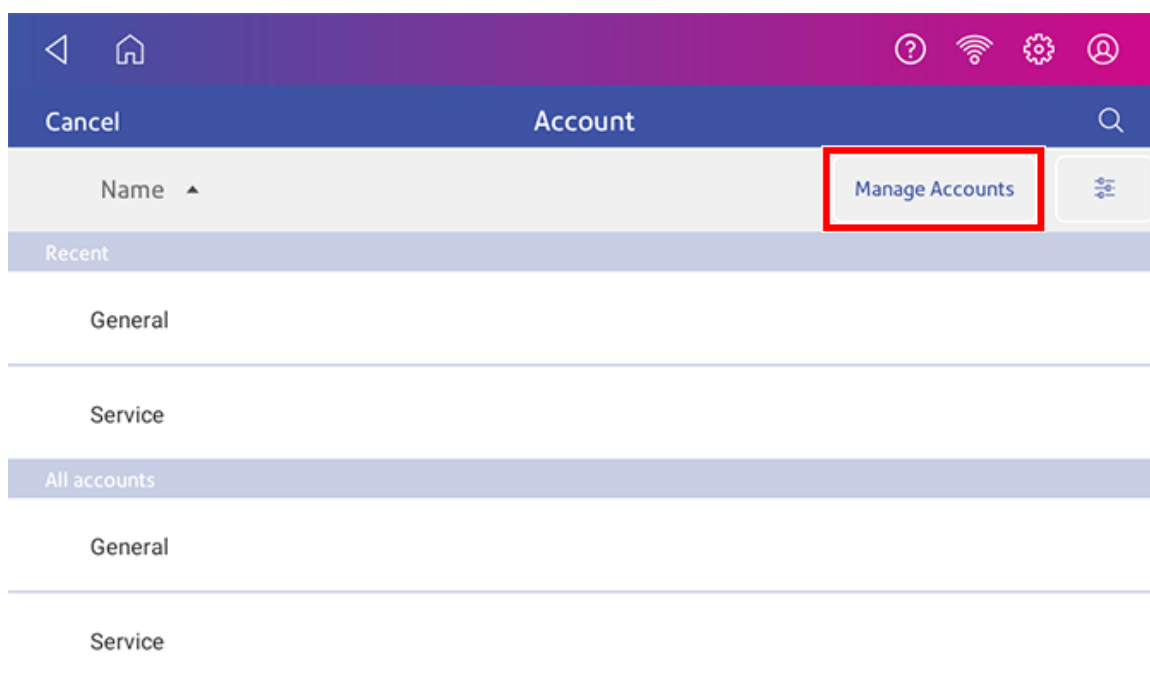

4. Tap the **Reports** link in the Accounts section.
5. If this is the first time you are running a report:
  - a. Tap **Report Period** and set the time range for your reports.
  - b. Tap **Preferences** and set how you wish to identify the accounts.
6. Set the report period.
7. Tap **View & print reports**.
8. Tap to select a report.

9. Tap **Next**.
10. Choose what to do with the report:
  - To view the report on the screen, tap **View Report**.
  - Tap **Actions** to save the report under a new name, delete, print, or email the report.

## Setting the postage printing account report period

Set the reporting period of an account report by setting the start and end dates of the report.

1. Tap **Envelope Printing** on the Home screen.
2. Tap **Account**.
3. Tap **Manage Accounts**.

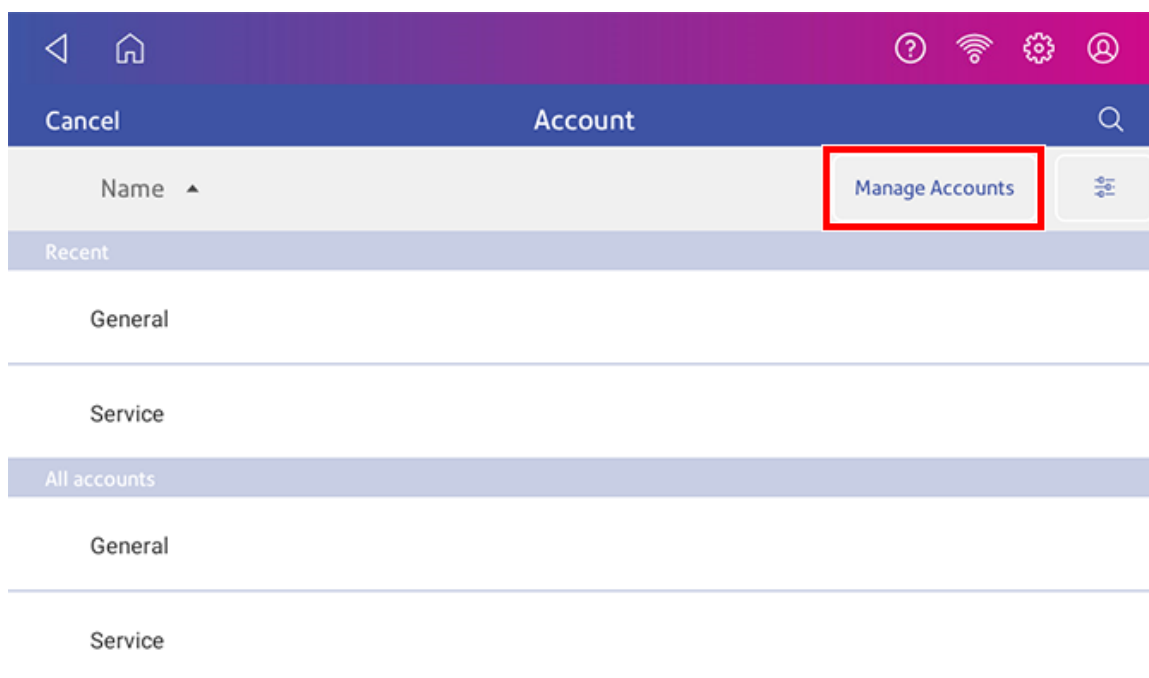

4. Tap **Reports**.
5. Tap **Report period**.
6. Select **calendar** next to the **Start date of fiscal year** field.
  - a. Select a date on the calendar.
  - b. Select **SET**.

The End date of the fiscal year is set based on the start date you enter. You cannot enter this date manually.
7. Select the **Default reporting period** field.
  - a. Select a report period type.
  - b. Select **OK**.

8. (Optional) Tap **Previous year** and **Next year** to view the reporting periods for the previous and next year. Tap **up** and **down** to scroll through the list of reporting periods for the current year.
9. Tap **OK** to return to the Reports screen.

## Setting the account report preferences

Set the account report preferences to select the account level you wish to report on (Account, Sub account or Sub sub account).

You can also choose how you want to identify accounts; by Name or by Code.

1. Tap **Envelope Printing** on the Home screen.
2. Tap **Account**.
3. Tap **Manage Accounts**.

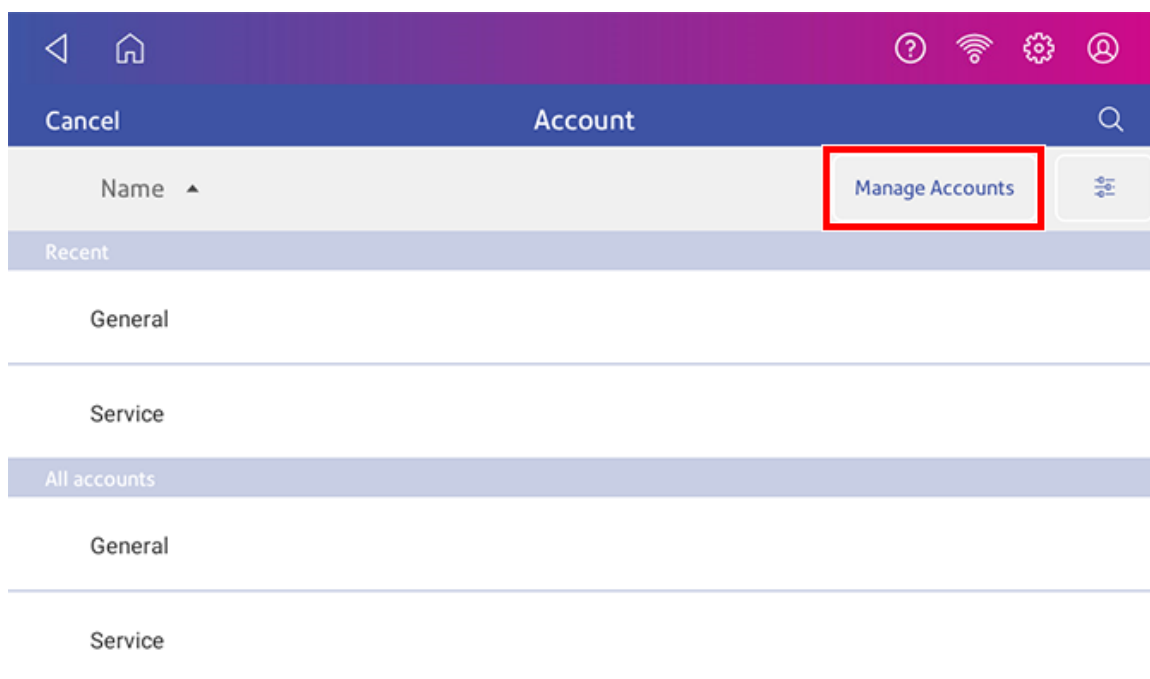

4. Tap **Reports**.
5. Tap **Preferences**.
6. Tap to select how you want to identify accounts: by **Name** or by **Code**.
7. Select the account level you wish to report on: **Account**, **Sub account** or **Sub sub account**.
8. Tap **OK** to return to the Reports screen.

## Emailing an account report

Email an account report to keep a record of how much departments or clients have spent on their postage over specific time periods.

1. Tap **SendPro Apps** on the Home screen.
2. Tap **Manage Accounts**.
3. Tap **Got It** at the No Sync Required prompt.
4. Tap **Reports**.
5. Tap **View & print reports**.
6. Tap the report to select it.
7. Tap **Next**.
8. Tap **Actions** or **View Reports** at the bottom of the screen.
9. Tap **Email Report**.

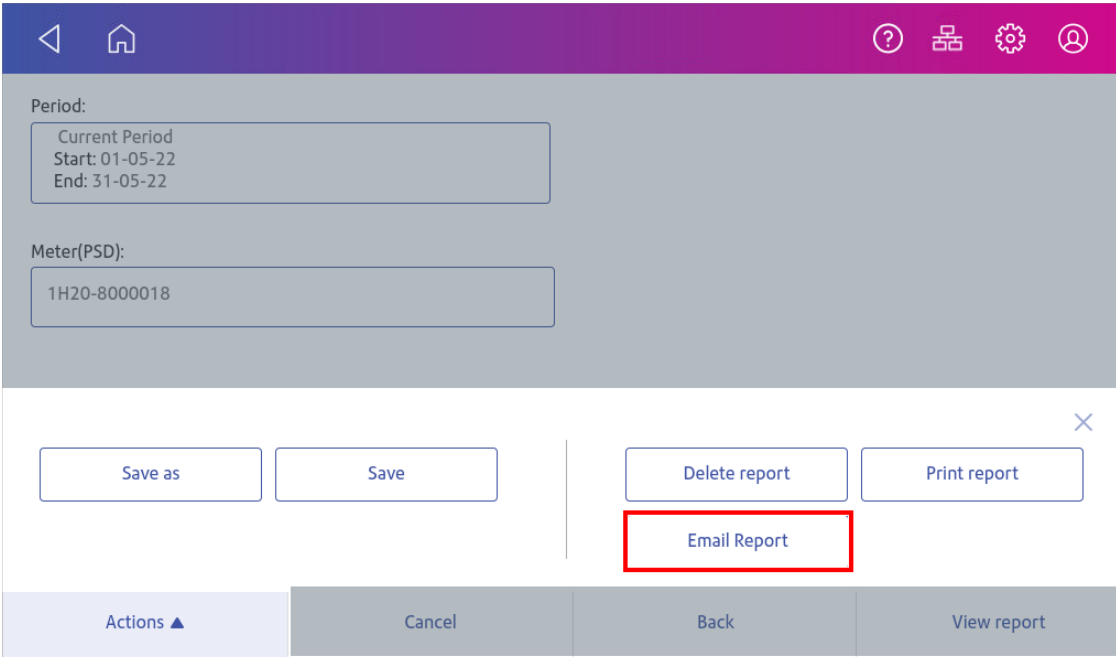

The screenshot shows a mobile application interface for generating and emailing a report. At the top, there is a purple navigation bar with icons for back, home, help, reports, settings, and profile. Below the bar, the screen is divided into sections. The first section, labeled 'Period:', contains a text box with the text 'Current Period Start: 01-05-22 End: 31-05-22'. The second section, labeled 'Meter(PSD):', contains a text box with the text '1H20-8000018'. Below these sections, there is a white area with a close button (X) in the top right corner. This area contains four buttons: 'Save as', 'Save', 'Delete report', and 'Print report'. The 'Email Report' button is highlighted with a red border. At the bottom of the screen, there is a grey bar with four buttons: 'Actions ▲', 'Cancel', 'Back', and 'View report'.

10. Tap in the **Please enter the recipient mail address** box and enter the recipient's email address. The email address you enter will remain until you turn off then turn on the device.

\* Please enter the recipient mail address:

\* Attach report as file type:

.xlsx

.csv

.pdf

\* Required fields

Cancel Send

11. Tap the file type you wish to send: **xlsx** (Excel), **csv** (comma-separated values), **pdf** (Portable Data Format).
12. Tap **Send**. The report appears from no-reply@pb.com.

# 10 - Printing

## In this section

---

What are print modes.....	108
Printing a custom or standard graphic.....	108
Adding a custom text message.....	111
Printing a graphic without printing postage.....	111
Printing only the date and time.....	112
Printing a test pattern.....	112

## What are print modes

As well as printing postage, your device uses other ways to print and feed mail. Tap **Print Mode** in the Envelope Printing app to see the available options.

- **Date and Time Stamp** - Print just the date and time. Your device will not print any postage.
- **Graphic only** - Print a graphic. Your device will not charge you for printing a graphic only.
- **Postage printing** - Postage printing is the default mode for printing mail.
- **Seal only** - Seal your envelopes. Your device will not print when you select Seal Only.

## Printing a custom or standard graphic

Customise your mail by adding a custom logo or standard graphic.

You can upload a graphic via Your Account. [Sign in](#) to the Pitney Bowes Your Account online portal.

### Downloading Custom Graphics

Tap **SendPro Apps** on the Home screen, then tap **Rates and Updates**. Your graphic downloads will then be available for printing.



## Standard graphics

Your device has a set of standard graphic images that you can add when you print postage.

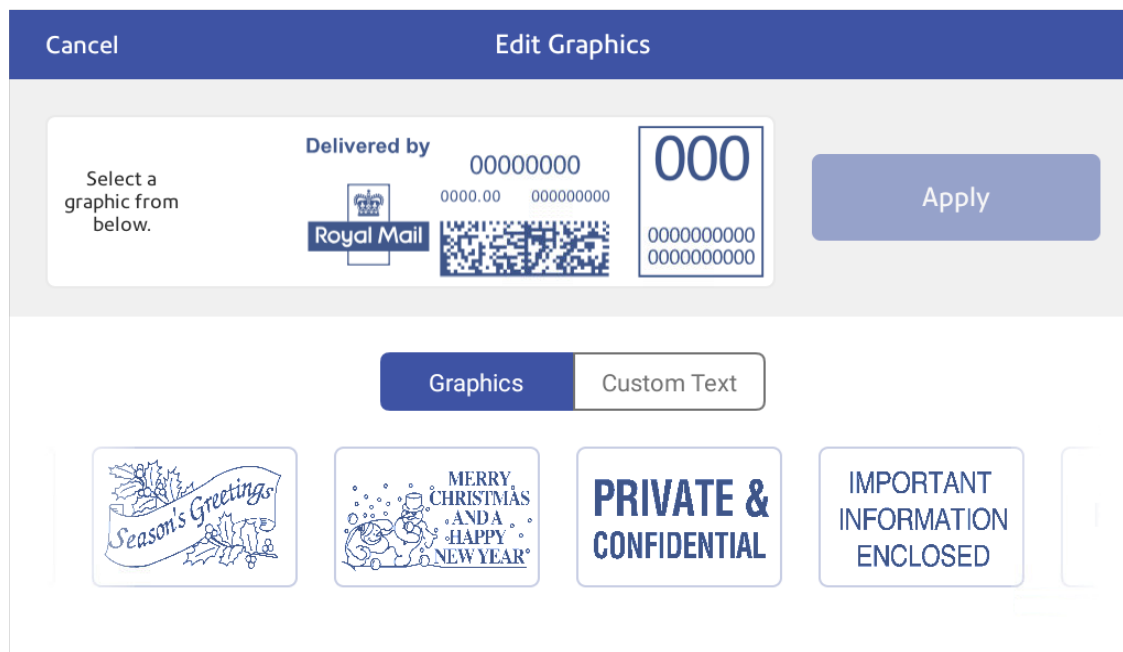

## Printing a custom or standard graphic

1. Tap **Envelope Printing** on the Home screen.
2. Tap **Account**, then select an account.

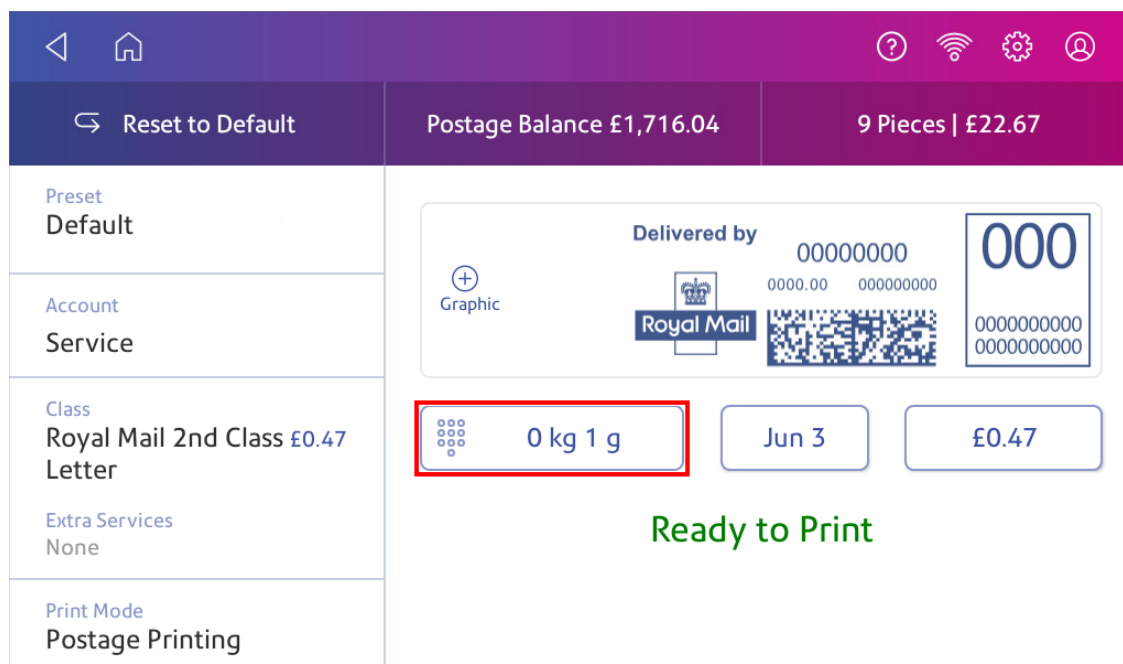
3. Tap **Weight**.4. Tap **Scale**.

5. Place the envelope on the scale. You must do this before the next step or else the **Apply** button remains inactive.

6. Tap **Class** then select the class of mail you want.

7. Tap **Graphic**.

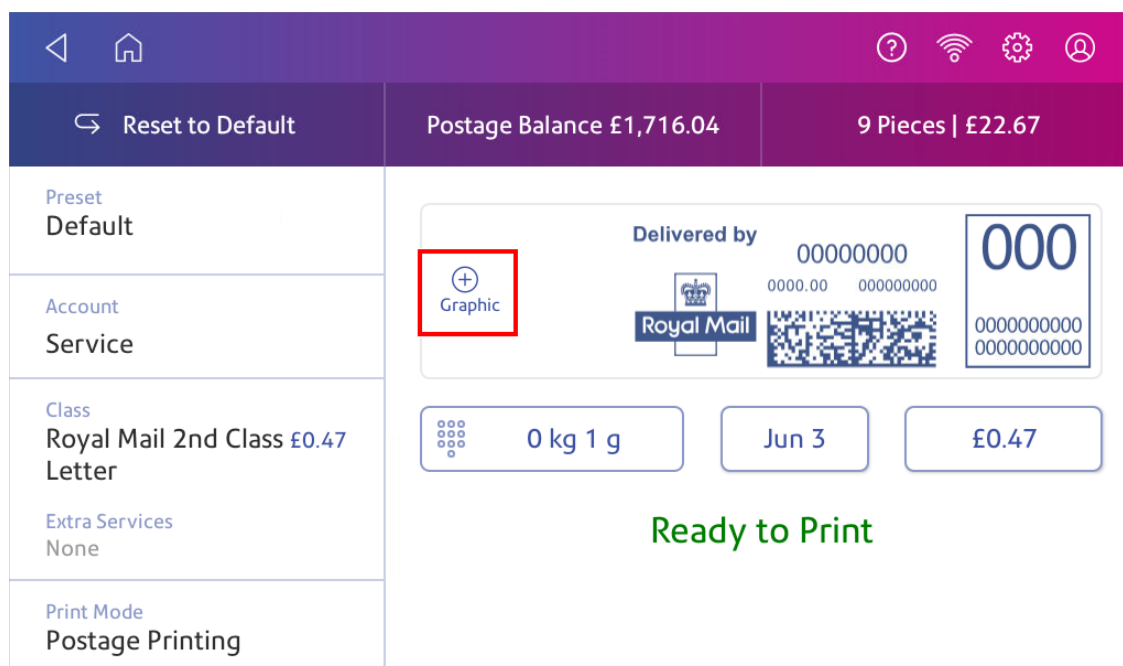

8. Select the graphic you want from the list.
9. Tap **Apply**.
10. Insert the envelope into the device to verify that the envelope prints correctly.

## Adding a custom text message

Add a text message to print a return address or to print your own personalised message. Your message must comply with the postal rules for your country.

Your message can be up to five lines, with 20 characters per line. The message prints on the left side of the envelope.

1. Tap **Envelope Printing** on the Home screen.
2. Weigh your envelope, select a class, and select special services, if required.
3. Tap **Graphic +**.
4. Tap **Custom Text**.
5. Tap **+ Add**.
6. Tap **Accept & Continue** to comply with the postal rules.
7. Enter a name for the message. The name can be up to 20 characters.
8. Tap **Save**.
9. Enter the message, line by line.
10. Tap **Apply** twice.
11. Insert the envelope into the device. The device prints the postage.

## Printing a graphic without printing postage

Print a graphic without printing postage, such as the Received graphic on incoming mail.

1. Tap **Envelope Printing** on the Home screen.
2. Tap **Print Mode**.
3. Select **Graphic Only**.
4. Tap **Apply**.
5. Tap **Graphic**.
6. Tap **Graphics**, then select your graphic.
7. Confirm with **Apply**.
8. Print the graphic on the envelope or tape.

## Printing only the date and time

Print the date and time to keep a record of when you receive incoming mail.

1. Tap **Envelope Printing** on the Home screen.
2. Tap **Print Mode** (you may have to scroll down to see this).

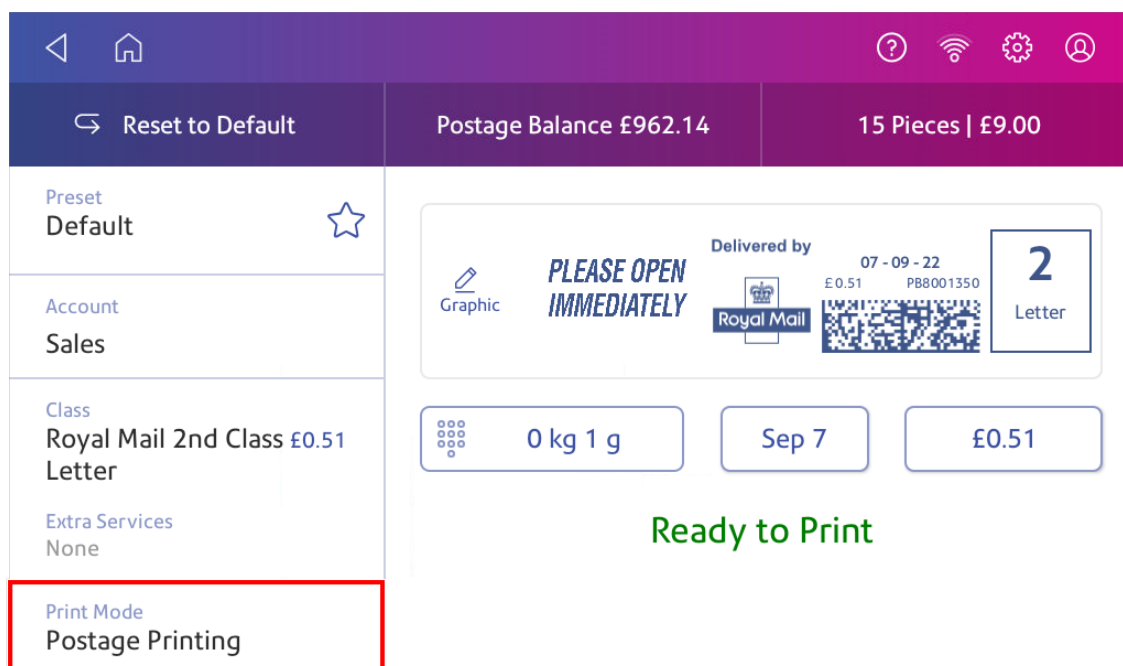

3. Select **Date and Time Stamp**.
4. Tap **Apply**.
5. Insert the envelope into the device. The device prints the envelope.

## Printing a test pattern

Print a test pattern to see if the printhead is working properly or if you have enough ink in the cartridge.

1. Tap **Settings**.



2. Scroll down and tap **Envelope Printer Maintenance**.
3. Tap **Print Test Pattern**.
4. Insert the envelope into the device when the message "Print a Test Pattern?" appears.

## 5. Examine the pattern printed on the envelope:

- Tap **Done** if the lines are unbroken and match the "Good" test pattern shown on the display.
- Tap **Clean Printhead** if the test pattern has missing or incomplete lines
  - Once the cleaning operation completes, you must print another test pattern.
  - If this new pattern still has broken or missing lines, you may need to replace the ink cartridge or clean or replace the printhead.
  - If you see no improvement in print quality, do not repeat the cleaning, as cleaning the print nozzles consumes ink.

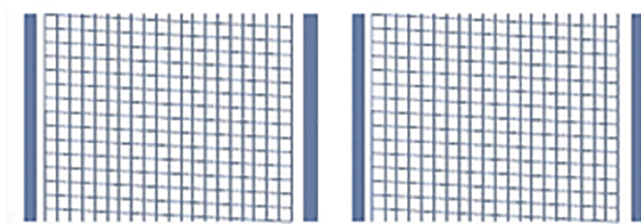
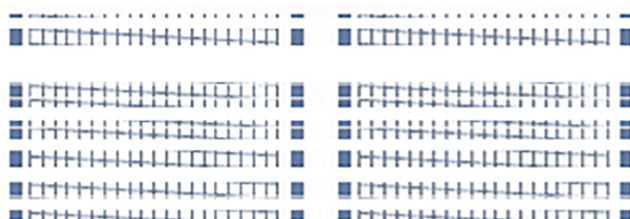
**Good Test Pattern****Bad Test Pattern**

# 11 - Feeding and Jamming

## In this section

---

Preventing envelope feeding problems.....	115
---	-----

## Preventing envelope feeding problems

Ensure you feed envelopes correctly to help prevent feeding problems.



### Feeding mail

1. For your first envelope, hold the far edge of the envelope against the back wall of the feeder.
2. Slide the envelope into the feeder until you feel it touch the rollers. You hear the motor begin. Do not release the envelope until the feeder grabs it to pull it through the device.



3. You hear the motor continue to run for about 5 seconds once it prints postage on the envelope.

4. Continue to insert envelopes one at a time. Make sure you press the edge of each envelope against the back wall of the feeder and into the feeder until it touches the rollers.
  - Make sure the envelopes fully exit the feeder and do not pile up on the edge of the feeder.
  - If you are using a stacker, you may need to extend the stacker tray so that the envelopes exit the feeder completely.

## Hold the envelope against the back wall to avoid skews

If you don't hold the envelope against the back wall it can skew. A skewed envelope can either exit the device with no postage applied or cause a jam. The message Clear Paper Jam appears. This could deduct funds. Even a minor skew that may be difficult to see can cause a jam.

## Cleaning the feeder

Using a can of non-flammable compressed air, blow on the feed deck on the left side and work toward the transport deck on the right side of the device. Make sure to remove all the dust and debris.



# 12 - Ink

## In this section

Checking the ink level.....	118
Ordering ink cartridges.....	118
Replacing the ink cartridge.....	119

## Checking the ink level

Check the ink level to ensure you have enough ink in your device.

1. Tap **Settings**.



2. Scroll down and tap **Envelope Printer Maintenance**.
3. View the level of remaining ink.

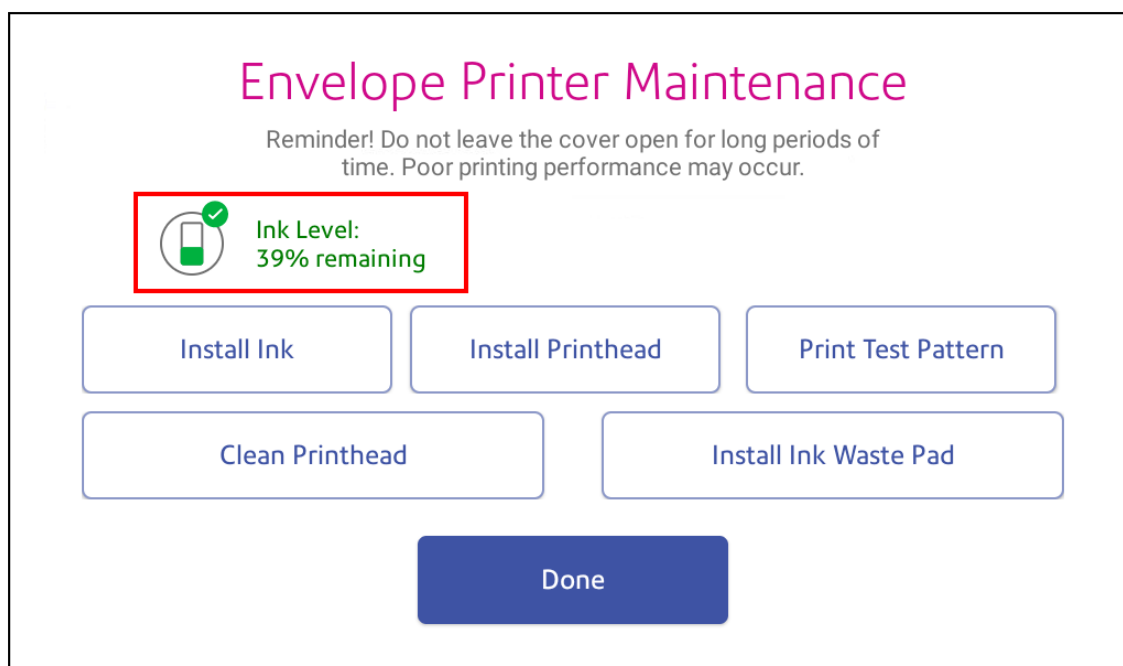

4. Tap **Done** to exit the screen.

## Ordering ink cartridges

Use postal approved ink cartridges. Non-postal approved ink cartridges can damage your device.

If you use the AutoInk program, you will receive an ink cartridge automatically when the low ink warning appears. To enroll in the in the AutoInk program, please contact Pitney Bowes.

## Replacing the ink cartridge

Replace the ink cartridge when the low ink warning appears. This ensures your device is in optimal working condition.

1. Tap **Settings**.



2. Scroll down and tap **Envelope Printer Maintenance**.
3. Tap **Install Ink**.
4. Lift the top cover. The ink cartridge moves to the front position.
5. Remove the ink cartridge, as shown on the label next to the cartridge holder.

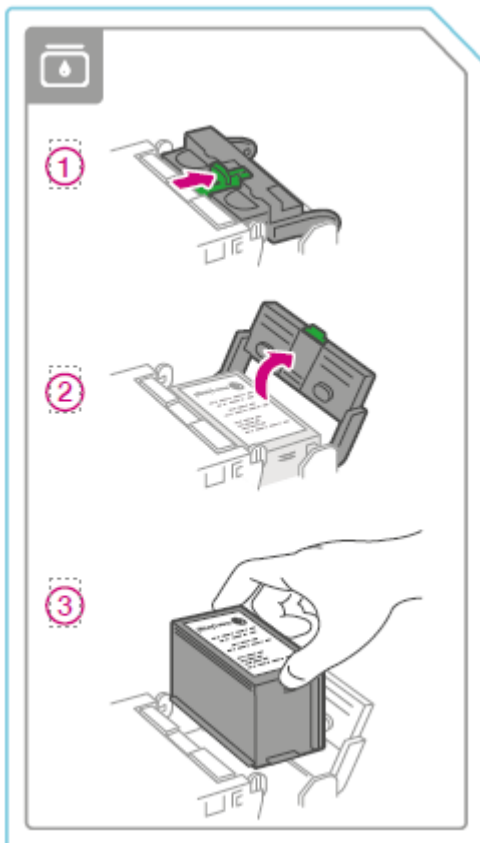

6. Insert the new ink cartridge, then close the ink cartridge guard.

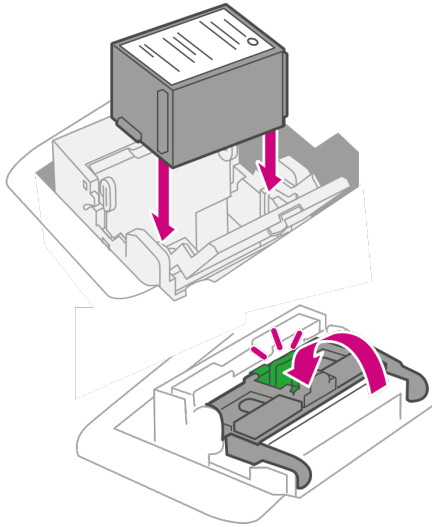

7. Close the top cover.

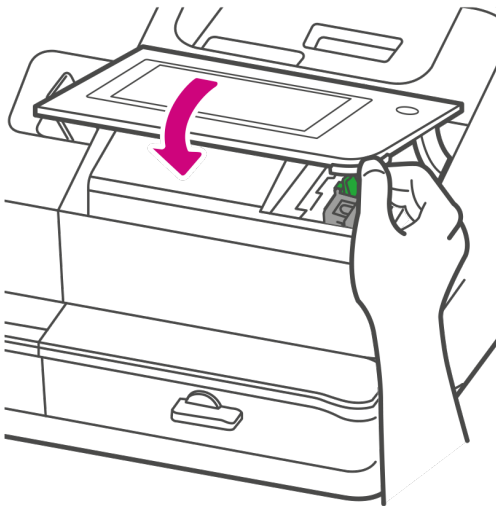

8. The cartridge repositions itself and the Envelope Printer Maintenance screen appears.
9. Print a test pattern to ensure that your ink cartridge installs properly.

# 13 - Settings

## In this section

---

What are presets.....	122
Adding presets.....	122
Selecting a preset.....	124
Renaming a Preset.....	124
Setting the default preset reset timer.....	126
Deleting a Preset.....	126
Advancing the date.....	127
Adjusting display brightness.....	127
Using the Toolbar.....	128
Adjusting the scale location code.....	129
Clearing or resetting the number of mailpieces sent.....	130
Creating or disabling the security PIN.....	130
Uploading postage transactions.....	131
Uploading system logs.....	132

## What are presets

A preset is a group of commonly-used settings that you use to quickly select the same settings in the future. Presets can store settings such as a postage class, an account and a graphic. The maximum number of presets you can create is twenty one. This includes the default preset.

Your device adds a default preset automatically once the installation is complete. You can edit the default preset to suit your own settings.

When your SendPro C, SendPro+ enters sleep mode or when you switch it off, it also reverts to the default preset.

## Adding presets

Add presets to store a group of settings. Presets can store settings such as a postage class, an account, and a graphic.

- *Define the settings you want to save*
- *Save the preset*

The maximum number of presets you can have is twenty one. This includes the default preset.

**Important:** Make sure there is nothing on the scale when you add the preset as the device will also save the weight of the mailpiece.

## Define the settings you want to save

1. Tap **Envelope Printing** on the Home screen.
2. Make sure your scale reads zero grams.
3. Define the settings:
  - a. Tap **Account** then select the desired account.
  - b. Tap **Class**.
  - c. Tap **Start Over**.
  - d. Select the desired class and any additional services you may require. Tap **Apply** to continue.
  - e. Tap **Graphic** to save a logo (Envelope Message) then select the logo you want.

## Save the preset

1. Tap the star in the Preset box.

**Important:** You must modify something in the Envelope Printing screen for the Preset star to appear.

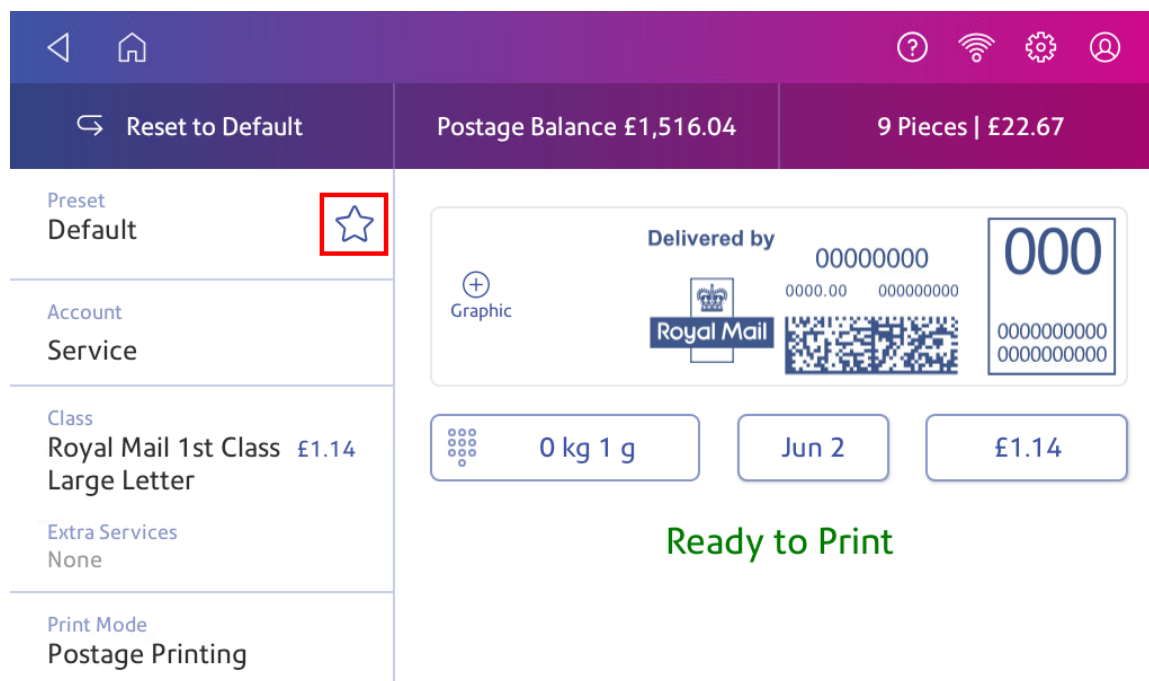

2. Tap **Save New Preset** to save it. If you wish to save it and replace the default setting, tap **Replace Default Preset**.

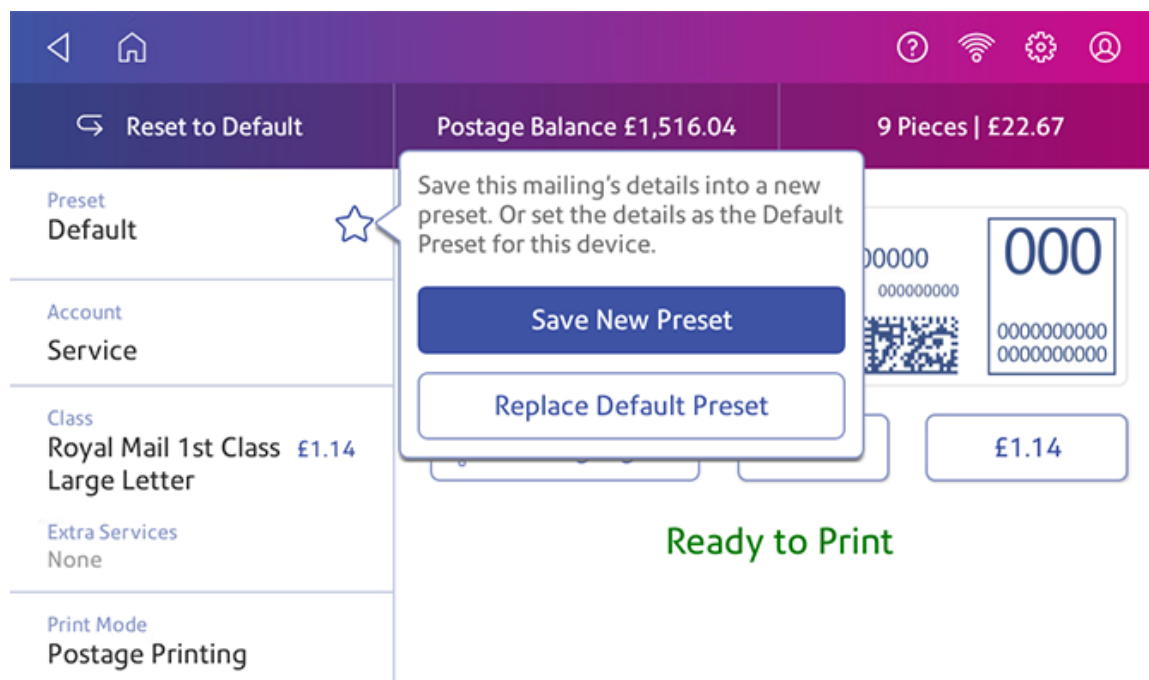

- For a new preset, enter a name, then tap **Enter** when complete.

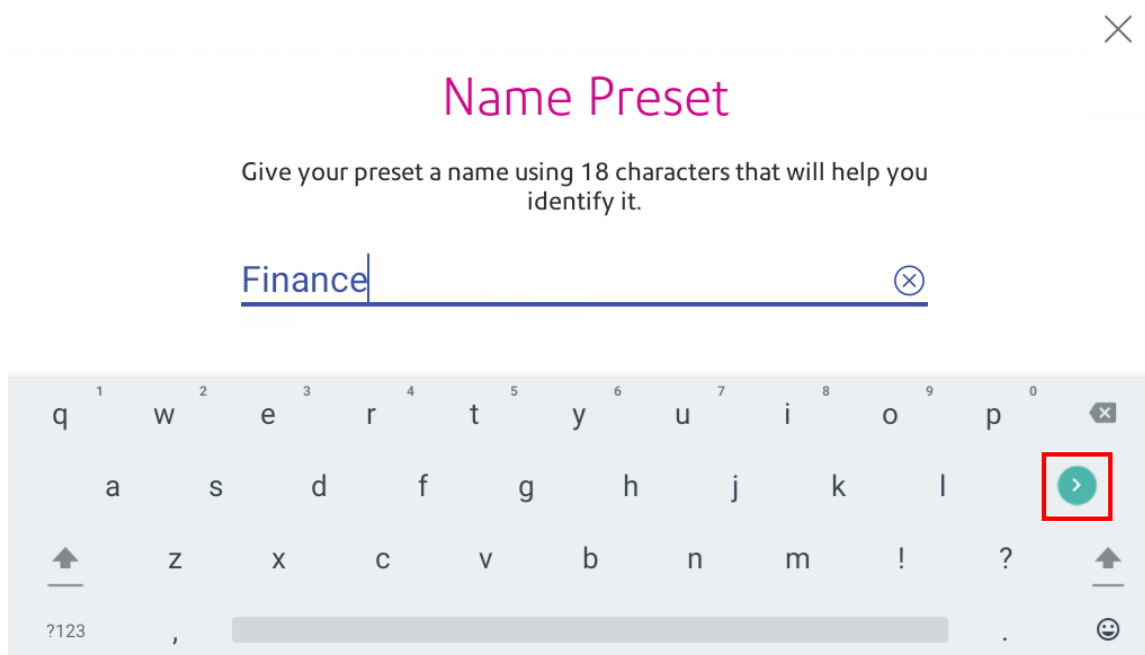

## Selecting a preset

Select a preset to quickly select a commonly-used group of settings.

- Tap **Envelope Printing** on the Home screen.
- Tap **Preset**.
- Tap the preset you want to use, then tap **Apply Preset**.

If you select a preset and do not use it within about one minute, the Envelope Printing app restores the default preset values. The same is true when you switch your device off or it enters sleep mode

## Renaming a Preset

Rename a preset when you change settings such as an account name or class.

- Tap **Envelope Printing** on the Home screen.
- Tap **Preset**.
- Tap the preset you want to rename.

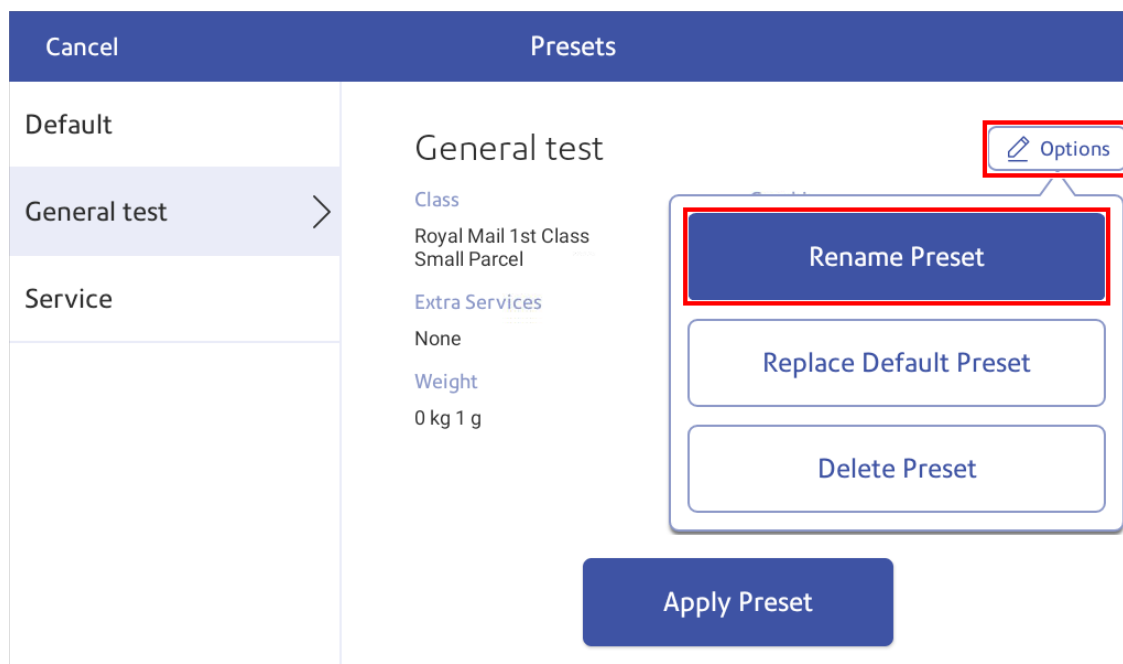
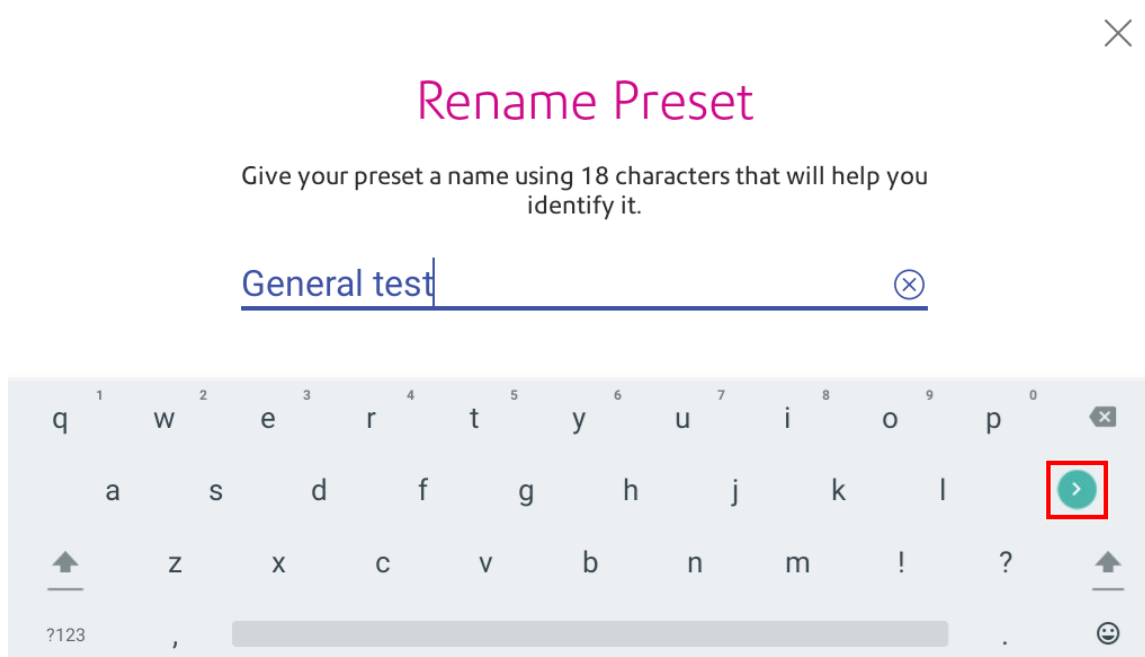

4. Tap **Options**.5. Tap **Rename Preset**.6. Enter the new preset name. Tap **Enter** to confirm.7. Tap **Cancel** to return to the Envelope Printing app.

## Setting the default preset reset timer

The default preset timer will reset your device to your most commonly-used settings. By default, the preset timer resets your device after one minute of inactivity. You can change this time if necessary.

1. Tap **Settings**.



2. Scroll down to the Envelope Printer Settings section.
3. Tap **Postage Refills**.
4. Tap **Default Preset Timer**.
5. Use the slider to set the time between 1 and 9 minutes.

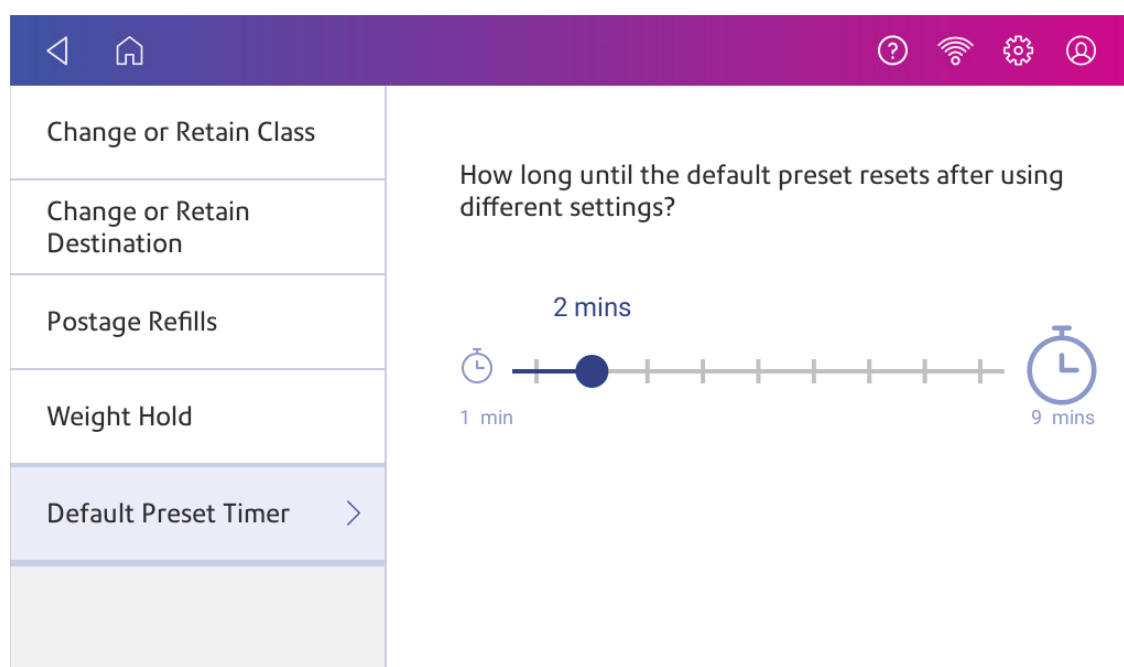

6. To save the value and exit the screen, tap the **back arrow** or **Home**.

## Deleting a Preset

Delete a preset when you no longer use this group of settings on your device.

1. Tap **Envelope Printing** on the Home screen.
2. Tap **Preset**.
3. Tap the preset you want to delete.

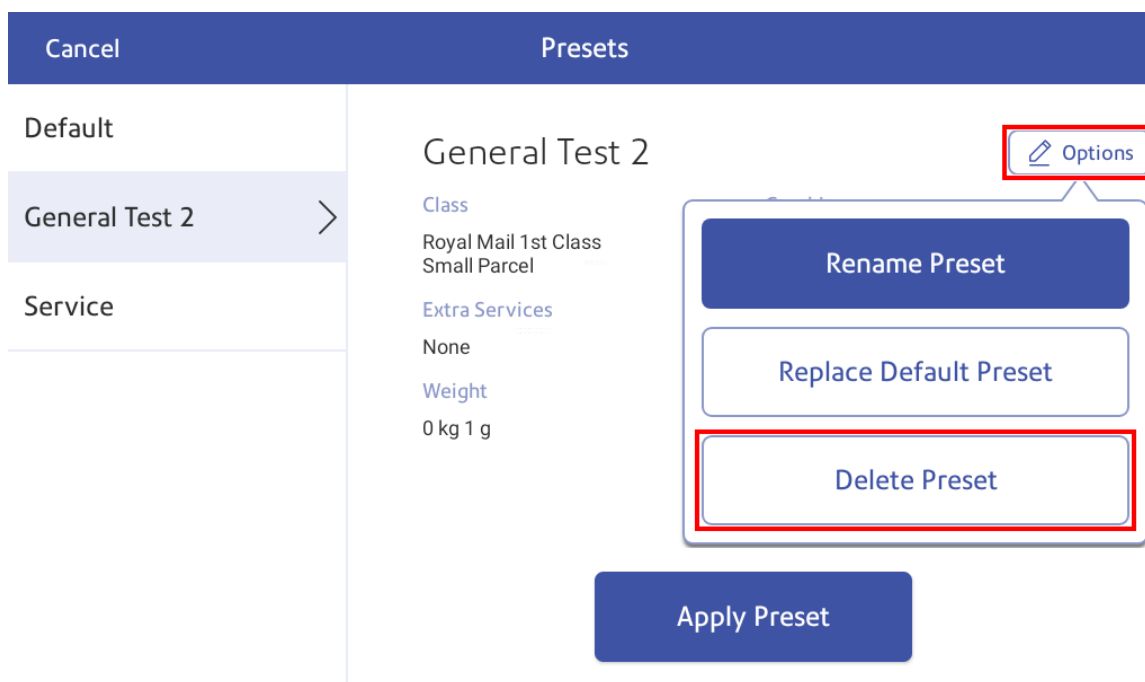
4. Tap **Options**.5. Tap **Delete Preset** twice.6. Tap **Cancel** to return to the Envelope Printing app.

## Advancing the date

Advance the date to print postage up to thirty days before you need to send it.

1. Tap **Envelope Printing** on the Home screen.
2. Tap the date. The calendar appears.
3. Tap **Tomorrow** or **Another Date**, depending on the date you wish to print.
4. When you see the future date highlighted on the calendar, tap **Apply**.
5. Insert the envelope into the device. The device prints the postage.

**Important:** The date on the postage should match the date when your mail goes to the post office. Your device automatically advances the printed date on the device stamp (as well as its internally held date) when the device time reaches 5:00 PM. You cannot change this time.

## Adjusting display brightness

Set the brightness of the display to suit your work space.

1. Tap **Settings**.



2. Tap **Display Brightness** in the Device & Network section of the screen.
3. Move the slider to adjust the brightness.
4. Tap the **back arrow** or **Home** image to exit the Settings screen.

## Using the Toolbar

The toolbar is located at the top of every screen.

Use the toolbar to:

- View and change settings and default values for your device.
- View online help.
- View information for your network type and wireless signal strength.



1. **Back** - Return to the previous screen.
2. **Home** - Return to the Home screen from any screen.
3. **Support** - Search support content and get help on how to perform tasks.
4. **Network** - View the current network type (wireless or wired) status and strength (for wireless connection). Allows you to turn wireless connection on or off. The icon here shows a wireless connection.
5. **Profile** - Lock your device when you have enabled the security PIN.
6. **Settings** - View or change your device and app settings. This includes changing the screen brightness, setting sound levels, and viewing wireless or wired connection information.

## Adjusting the scale location code

When you move your device to a new address in a different region or install a new scale, you need to check the location code is correct.

1. Tap **Settings**.



2. Tap **Location & Time Zone**.
3. Check the location code is correct.

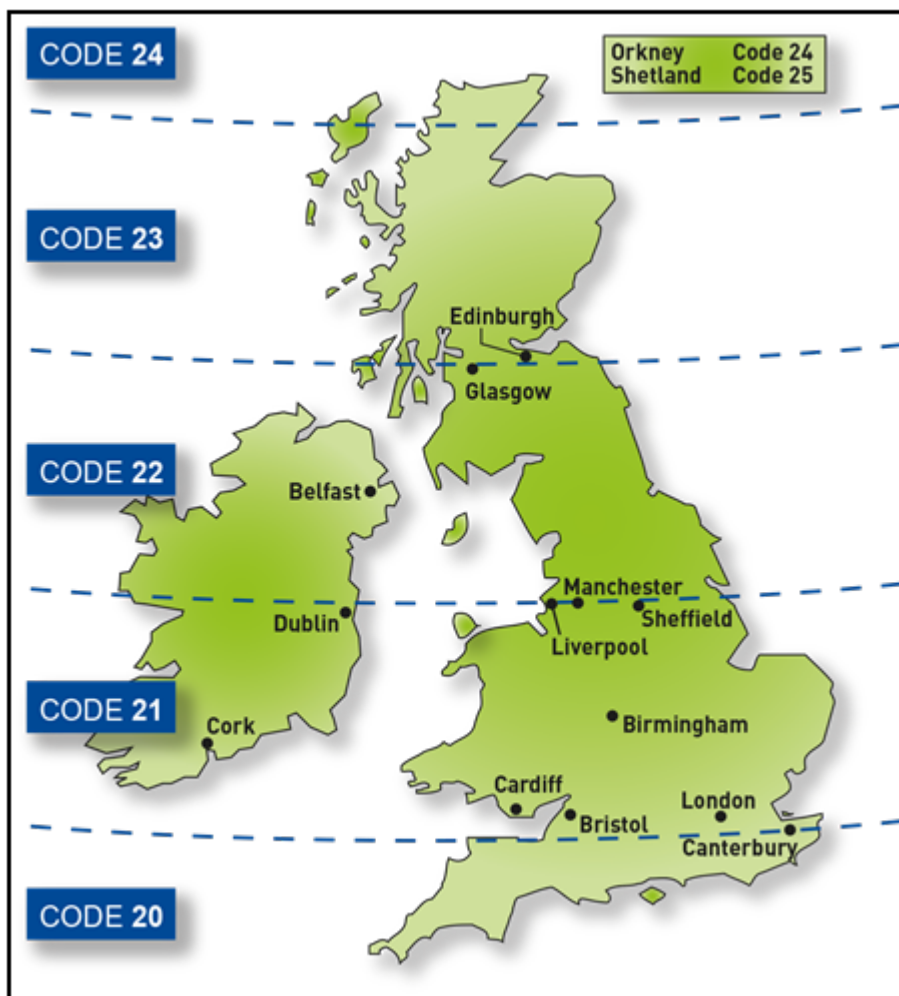

4. Tap **Apply** to confirm.

## Clearing or resetting the number of mailpieces sent

Reset the piece counter to delete the piece count information.

Make certain that you wish to delete the piece count information. Once you do so, you cannot restore the deleted data.

1. Tap **Envelope Printing** on the Home screen.
2. Tap **Pieces**.
3. Tap **Reset Counter to 0**.

## Creating or disabling the security PIN

Create a security PIN to prevent unauthorised use of your device.

If you created a security PIN when you installed your device, you must enter it when you turn your device on or after it enters sleep mode.

### Create a security pin

1. Tap **Settings**.



2. Tap **Security PIN** in the Device & Network section.
3. Tap **Create PIN**.
4. Enter a 4-digit numeric PIN using the keyboard on the display.
5. Verify your PIN by entering it again.

### Change or disable the security PIN

1. Tap **Settings**.



2. Tap **Security PIN** in the Device & Network section.
3. Tap **Change PIN** or **Turn OFF Security PIN**.
4. Enter the current security PIN for either option.

## Manually lock your device

1. Tap the user profile image.



2. Tap **Lock this device**. The screen saver displays shortly after the Device is Locked screen appears.

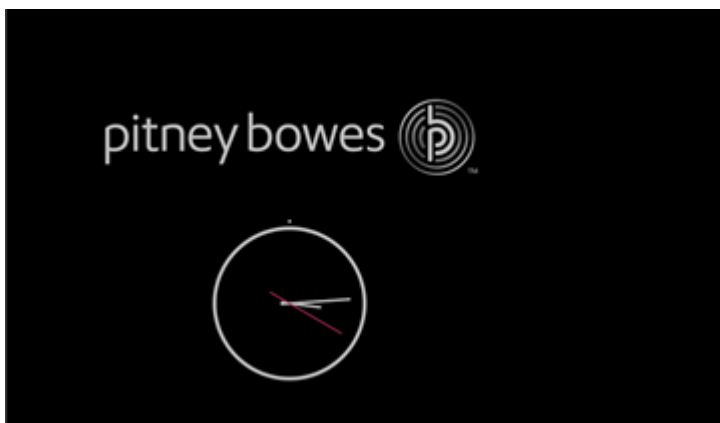

If you forget your Security PIN, tap on the **Forgot PIN?** link to get help.

## Uploading postage transactions

### Automatic upload of your postage transactions

- Your device automatically uploads your postage transactions to the Pitney Bowes Data Center. This occurs at least once during the day and once after hours.
- If you lock your device or turn it off for any extended period, it automatically uploads your transactions when you turn it on again.
- If you see the message "Sync your data", it means you need to upload your transactions.

**Important:** If your device had connection issues recently, it may require multiple uploads to upload transactions. If the device prompts you to upload more than three times, please contact technical support.

## Manual upload of your postage transactions

1. Tap **Settings**.



2. Scroll down to the Envelope Printer Settings section.
3. Tap **Sync Transaction Data**.
  - A series of messages appear, starting with "Preparing Transaction Data" followed by "Sending Transaction Data."
  - Once the upload is complete, the message "Transaction Data Sent" appears.
  - The message "No Sync Required" appears if there are no new transactions to upload.

## Uploading system logs

Your device creates system logs that monitor operations on your device. If you need to upload system logs to a Pitney Bowes support representative, you can find them in the Advanced Device Options section under Settings.

1. Tap **Settings**.



2. Scroll down to the Advanced device Options section.
3. Tap **System Log Upload**.
4. Select the logs you want to upload.
5. Tap **Upload Selected Logs**.



6. Once the upload completes, an upload message bar appears at the bottom of the screen.
7. Tap **OK** or **Got It** in the message bar.
8. Tap **Home** to exit.

# 14 - Rate Change

## In this section

Updating postal rates or software.....	135
--	-----

## Updating postal rates or software

### Update software and rates automatically

Your device updates postal rates and software automatically.

Keep your device turned on and connected to the internet to receive automatic updates. The device downloads updates during the evening hours.

### Check for rate or software updates manually at any time

Even though your device checks for updates automatically, you can check for rate and software updates at any time.

1. Tap **SendPro Apps**, then tap **Rates and Updates**.
2. If new rates are available, your device downloads and installs the updates.

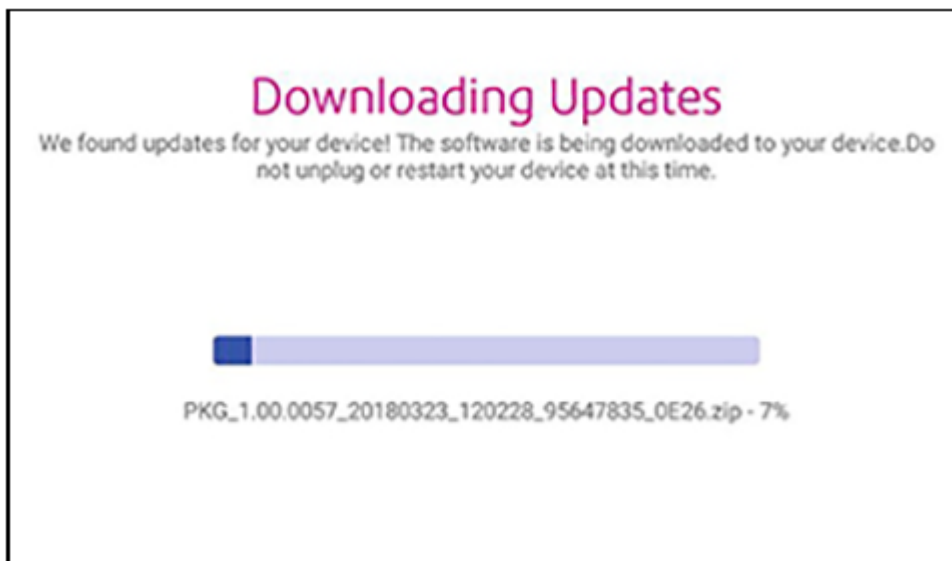

3. Once the download and install process completes, the message "Updates successful" appears.

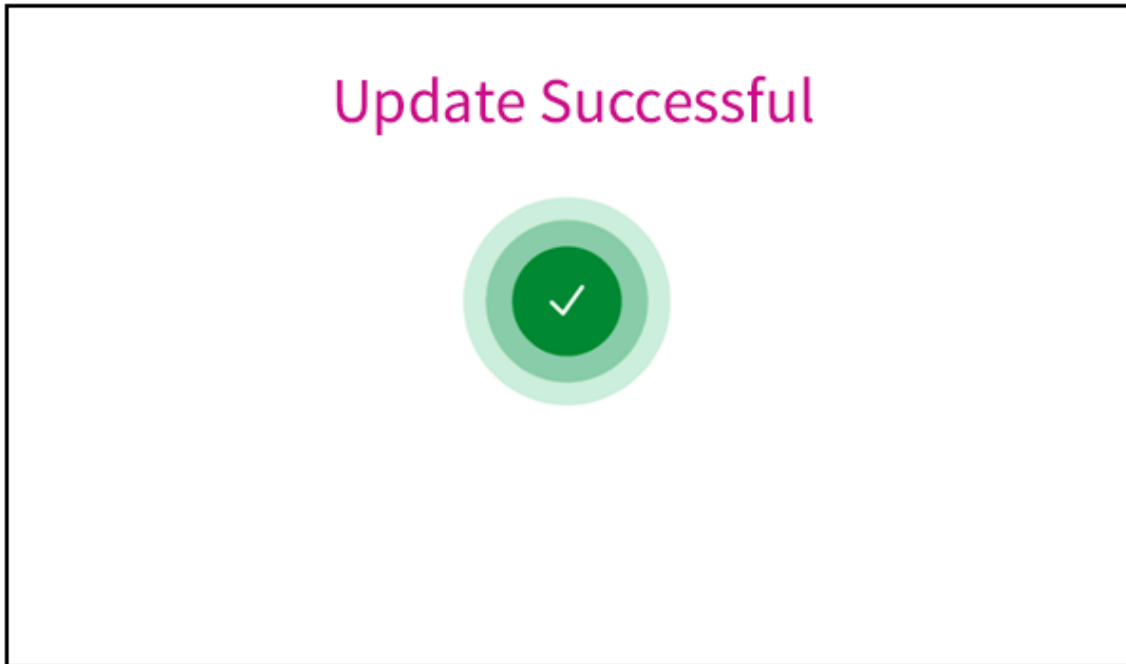

# 15 - Maintenance

## In this section

Cleaning the printhead.....	138
Cleaning the moistener brush and wick assembly.....	141
Ordering supplies.....	146

## Cleaning the printhead

If you clean the print nozzle and you still get a bad test print pattern, try cleaning the printhead.

1. Tap **Settings**.



2. Scroll down and tap **Envelope Printer Maintenance**.
3. Tap **Install Printhead**.
4. Lift the cover. The ink cartridge moves to the front position.
5. Flip the ink cartridge cover open.

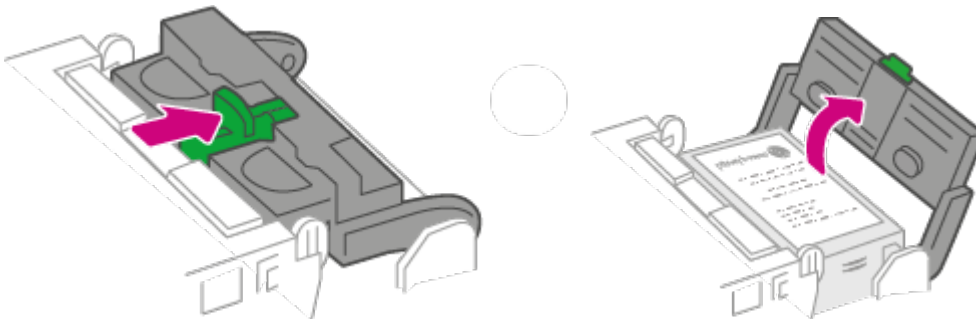

6. Remove the ink cartridge.

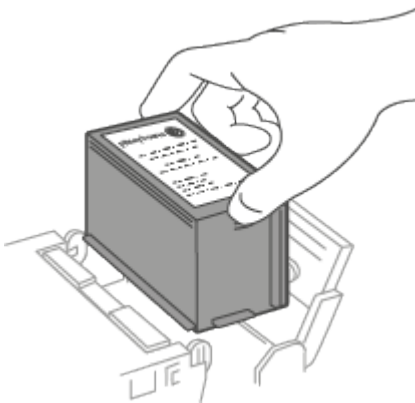

7. Squeeze the tabs on either side of the printhead.

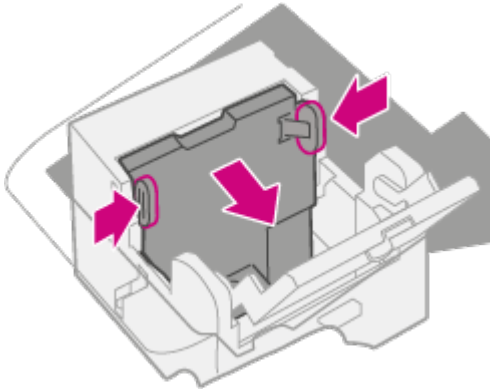

8. While squeezing, lift and tilt to the printhead to the right. The printhead should come up out of the device.

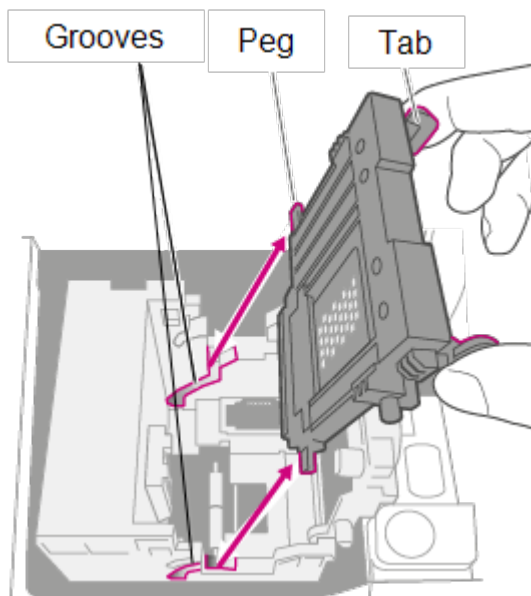

9. Clean off the printhead by wiping the surface of the printhead with a dry, lint-free cloth or a foam swab.

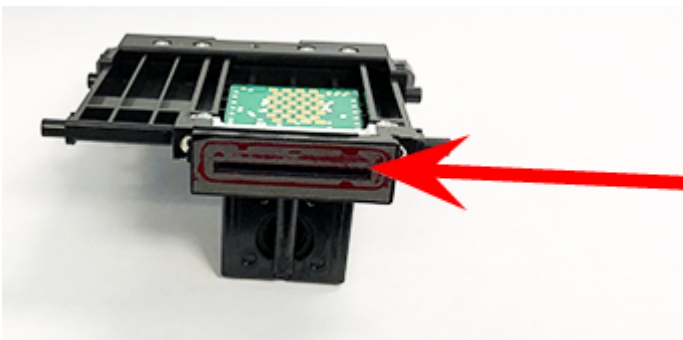

10. Squeeze the tabs and slide the printhead pegs into the lower set of grooves.

**Warning:** If you do not seat the printhead correctly it can damage the device.

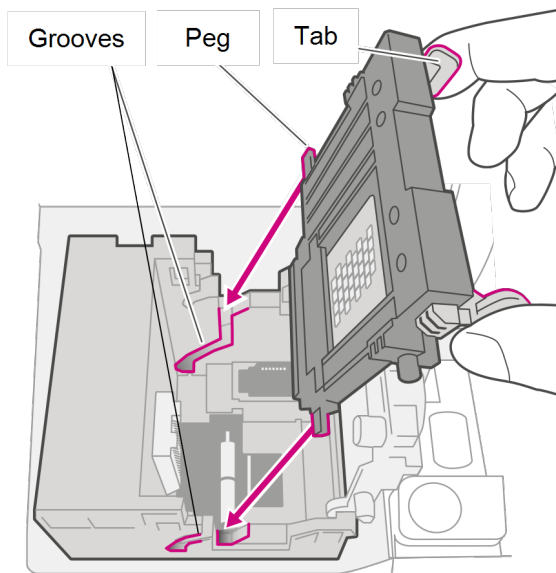

11. Keep squeezing the tabs and push the printhead flush against the wall. The tabs snap outward when placed correctly.

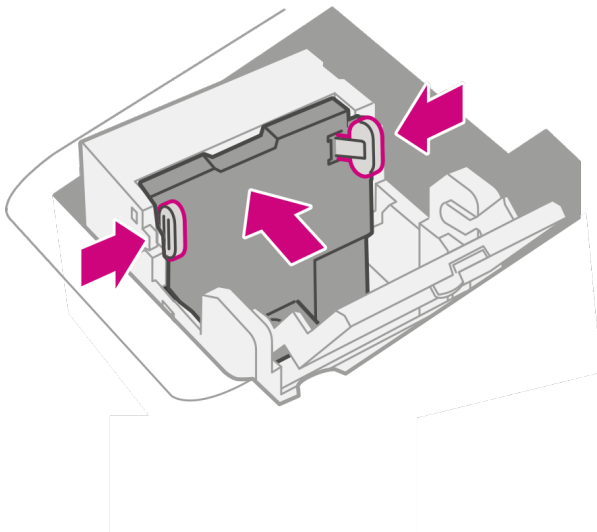



12. Install the ink cartridge and close the guard.

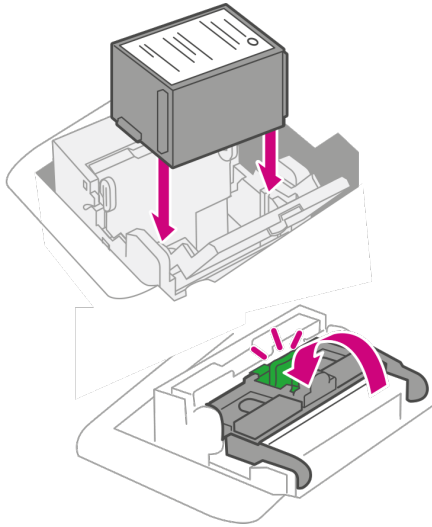

13. Close the cover. The ink cartridge moves back to the original position.

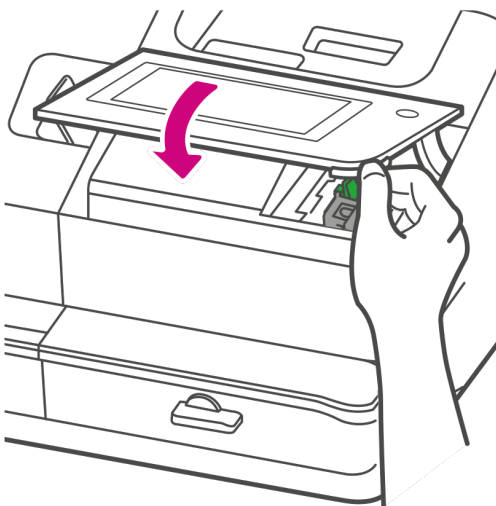

14. Tap **Done**.
15. Print a print test pattern to be sure that your printhead is functioning properly.
16. If the test pattern looks good, tap **Done**.

## Cleaning the moistener brush and wick assembly

Clean the moistener brush and wick if the moistener tank is full and your envelopes are not sealing properly.

1. Unscrew the plastic thumbscrew under the moistener base.

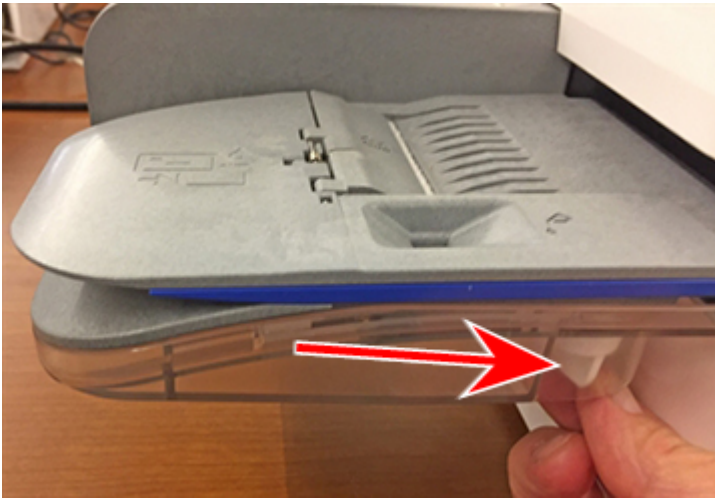

2. Lift the moistener brush assembly off the top of the moistener base.



3. Turn the assembly over and slide the moistener brush out of the holder.

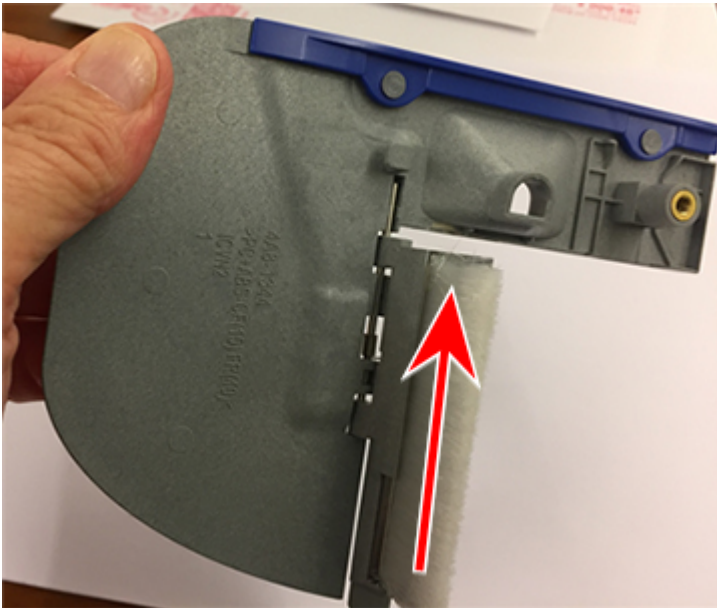

4. Locate the wick on the moistener base.

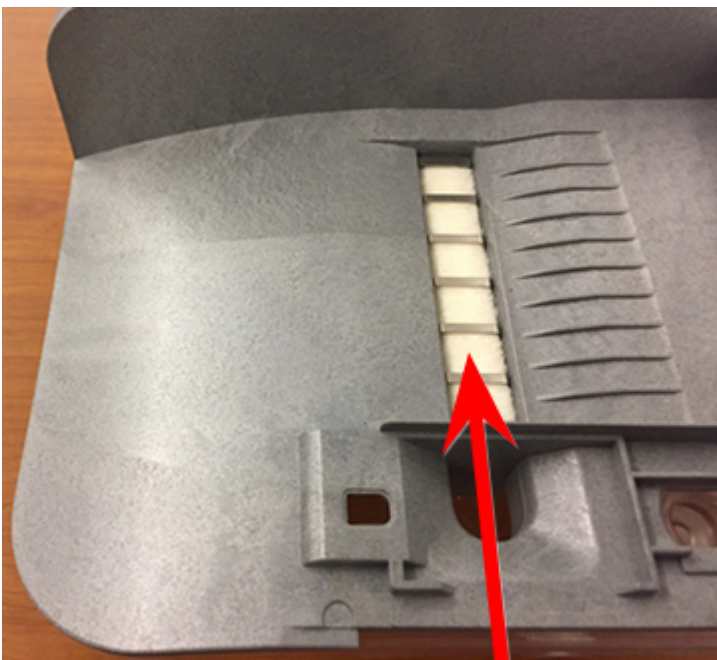

Wick

5. Remove the metal grate and wick from the moistener base.

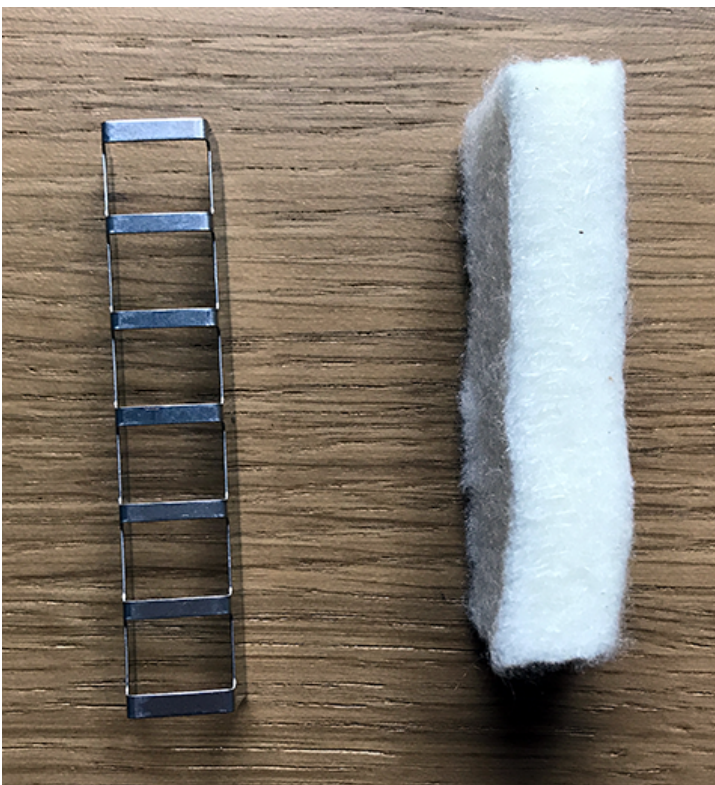
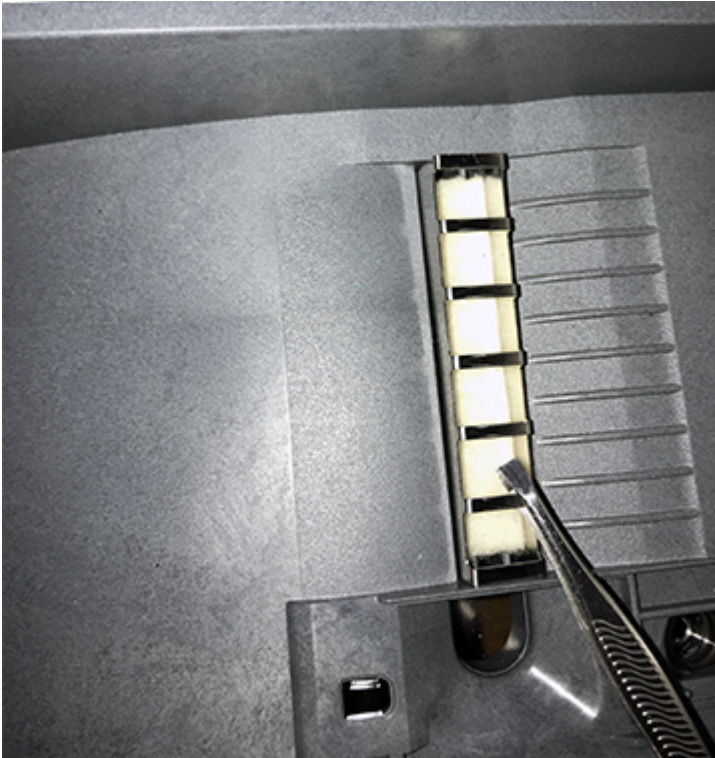

6. Clean the brush and wick with water and rinse thoroughly.

7. Place the wick back in the metal grate and replace the grate in the moistener base.
8. Slide the moistener brush back into the holder.
9. Replace the moistener brush assembly on top of the moistener base and secure with the plastic thumbscrew.

## Ordering supplies

Visit our [supplies website](#) to order supplies for your device.



# 16 - Product Information

## In this section

Finding the Product Code Number (PCN) and serial number	148
Navigating the Home screen	149
Navigating the Envelope Printing app	149
Connections on the back	150
Royal Mail requirements	151
Parts of the SendPro C, SendPro+	151
Parts of a postal frank	152
Postal Security Device	153
Specifications	153
Material specifications	156
Moving the SendPro C, SendPro+	158
Important safety notes	158
Contacting Pitney Bowes	160
Third party software	161

## Finding the Product Code Number (PCN) and serial number

In order to find the correct information for your device, you need to know the model number.

To locate the **(1) Product Code Number (PCN)** and the **(2) 7-digit serial number**, check the label on the rear of the device or under the display cover. The serial number appears as zeros here for security reasons.

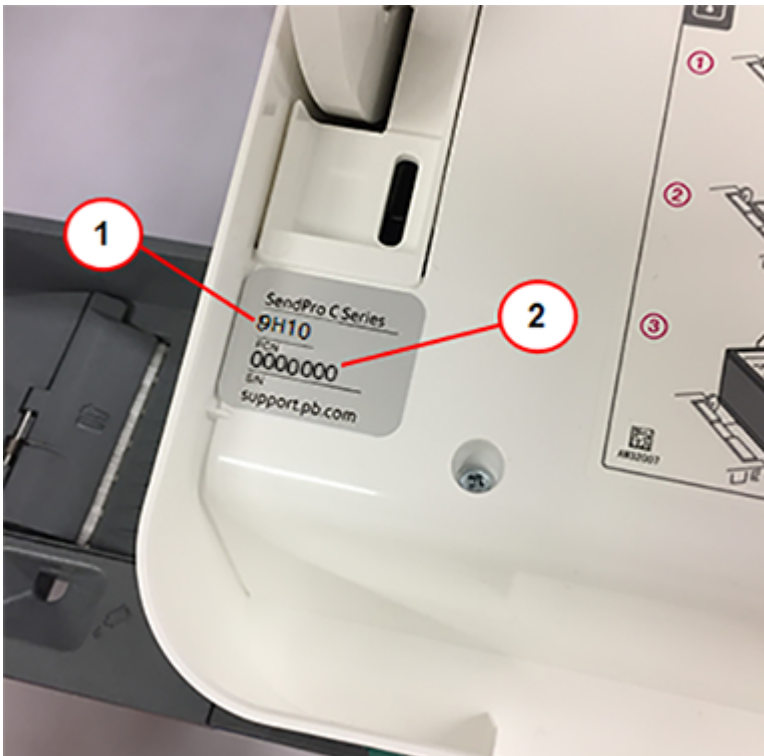



## Navigating the Home screen

The Home screen is the first screen you see after switching the device on or if you wake it from sleep mode. The Home screen provides the starting point for printing a Parcel Shipping label or printing postage.

Tap the Home icon in any screen to return to the Home screen.

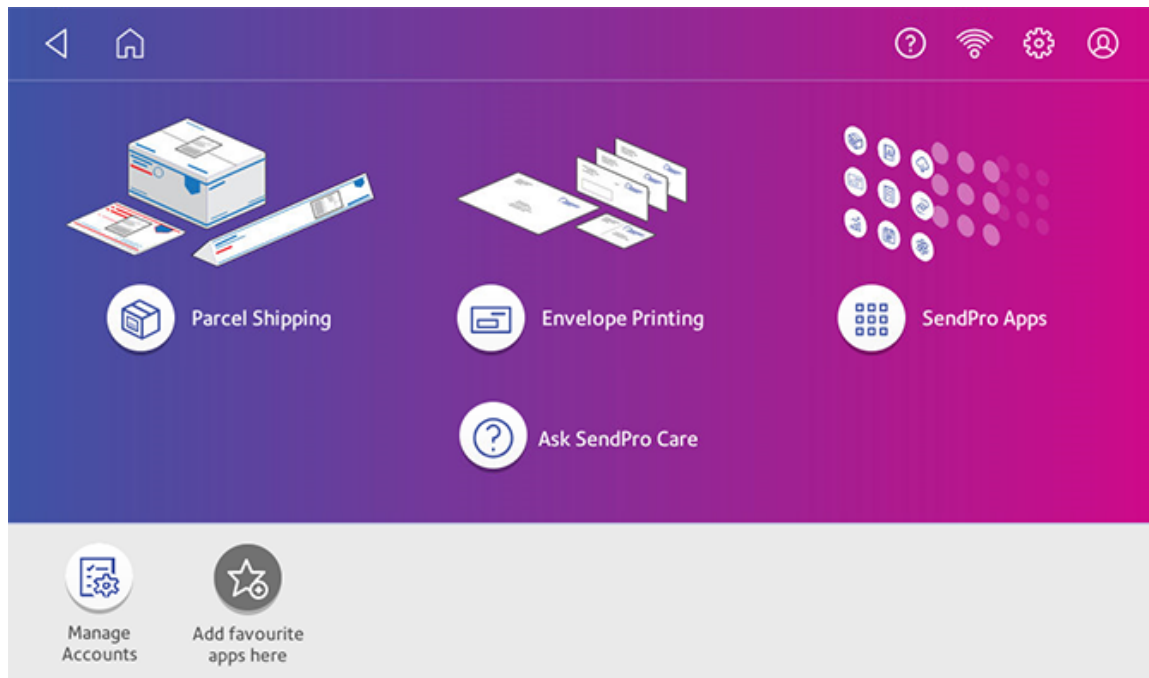

- **Parcel Shipping:** Tap **Parcel Shipping** to print Parcel Shipping labels for important large envelopes or parcels using Royal Mail or ParcelForce.
- **Envelope Printing:** Tap **Envelope Printing** to print envelopes, post cards and small parcels.

## Navigating the Envelope Printing app

The Envelope Printing app is the starting point for printing postage on an envelope or tape. It also allows you to change what you print.

Tap **Envelope Printing** to open the Envelope Printing app.

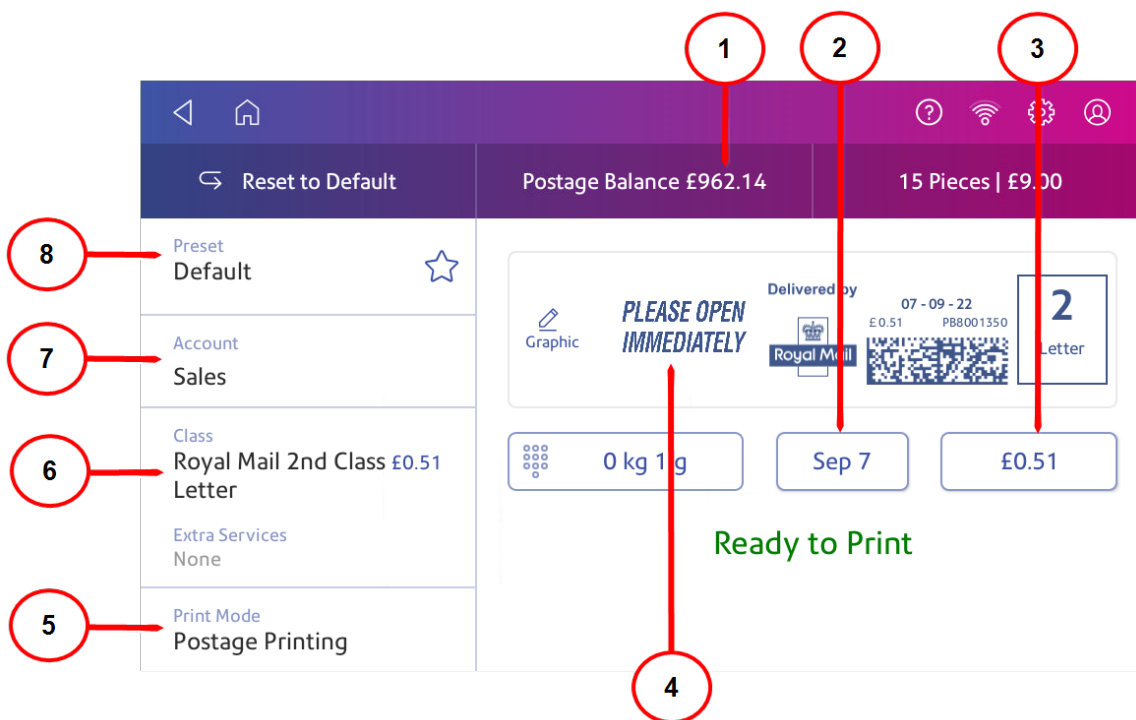

On this screen, you can:

1. **Postage Balance** - View the balance of funds you have left in your device.
2. **Date** - Tap the date to view the date options.
3. **Total postage amount** - View the total postage amount.
4. **Graphic** - Tap **Graphic** to preview or add graphics. You can also add a custom text message.
5. **Print Mode** - View the available printing modes such as printing a graphic only, printing the date and time, or seal envelopes without printing postage.
6. **Class** - Tap **Class** to view available postal classes and any extra services.
7. **Account** - Tap **Account** to charge back postage to departments or clients. Run reports showing how you spent your postage over specific time periods.
8. **Preset** - Tap **Preset** to store a group of commonly-used settings. Presets can store settings such as a postage class, an account and a graphic.

## Connections on the back

Familiarize yourself with the ports on the back of your device.

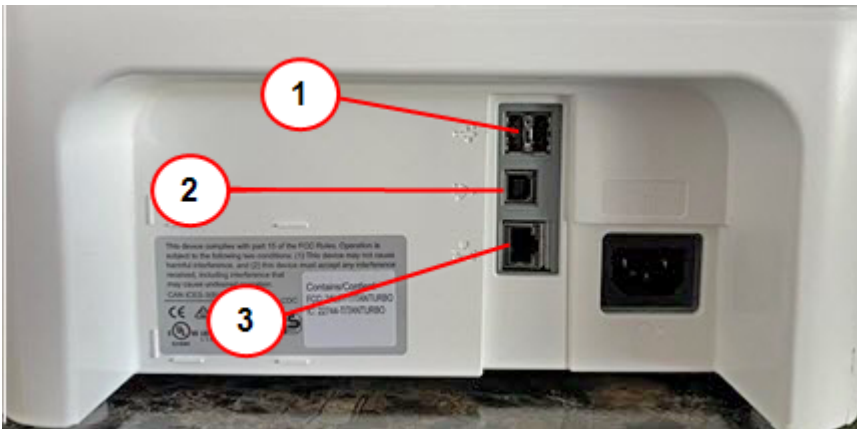

1. **USB port type A host** - Connect a Barcode scanner or external scale to these ports.
2. **USB port, type B host** - Service personnel use only.
3. **RJ45** - Use for a wired network connection.

## Royal Mail requirements

To prevent mail delays or rejections, follow Royal Mail requirements.

Your device (Postal Security Device) has a license with the Postal Authority. Therefore, you must follow a few basic requirements.

- Mail must have the correct date and postage amount shown.
- Always ensure that your postal prints are clear and complete. Poor prints may result in Postal Authority being unable to offer the service you requested. Prevent mail rejections by Postal Authority by ensuring mail is legible.
- If you move to another address, you must update Postal Authority records. Contact your local device supplier for advice.
- Postal printing ink and the tape sheets for putting postage on larger items must conform to postal specifications. For best performance, obtain ink cartridges and tape sheets directly from your device supplier.

## Parts of the SendPro C, SendPro+

Familiarize yourself with the parts of your SendPro C, SendPro+.



1. **Integrated scale** - Weigh envelopes and packages.
2. **Color touchscreen display** - Provides access to the apps available on your device.
3. **Ink access cover** - Allows access to the ink cartridge. Find the model and serial numbers inside.
4. **Envelope stacker** - Mail collects here after the printing process.
5. **Paper jam lever** - If a stall occurs on the transport deck, turn this to clear the envelope, post card or tape strip.
6. **Envelope moistener** - Moistens the flap of the envelope.
7. **Semi-automatic feeder** - Feeds and seals envelopes. Also feeds postcards and tape strips.
8. **Optional thermal label printer** - Prints shipping labels without using ink.

## Parts of a postal frank

The postal frank impression contains components that identify the mailer and the type of mail.

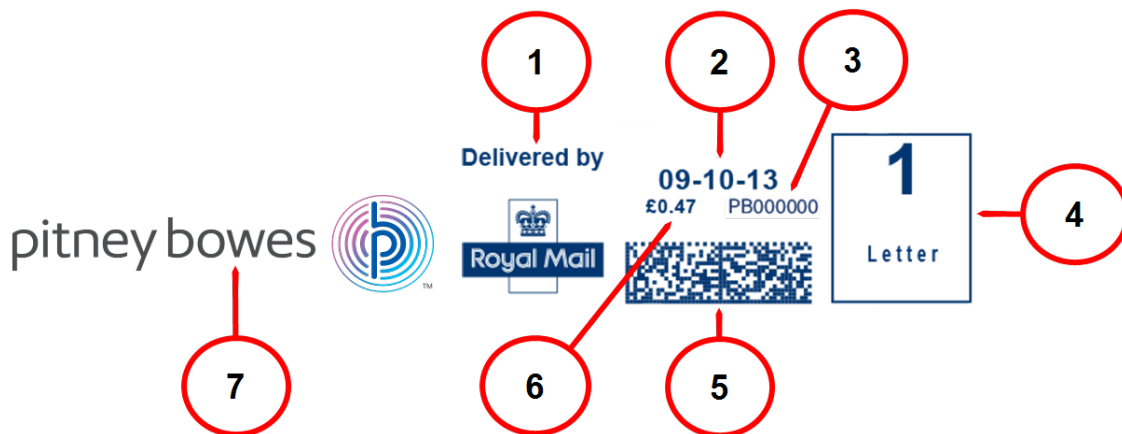

### Required parts

1. Carrier.
2. Date.
3. Device serial number.
4. Class of mail selected.
5. Mailmark barcode.
6. Postage amount

### Optional parts

7. Advertisement (graphic)

## Postal Security Device

The postage meter on your mailing system is a Postal Security Device (PSD) that secures your postage funds. It includes the latest technology approved by Royal Mail. This technology eliminates the need for Royal Mail to perform physical inspections, thereby making your device easier and more convenient for you to use.

## Specifications

Review the specifications of your SendPro C, SendPro+ including the throughput, ink cartridge yield and other component details.

### Power requirements

100-240 VAC, 50/60 Hz, 1.0 A

## Operating Temperature

13°C to 35°C

## Sound Level

Less than or equal to 70 dBA re 20 micro Pascal in accordance with ISO 7779, ISO 3744, or ISO 3741.

## Dimensions

419 mm L x 394 mm W x 286 mm H



## Weight

8 kg

## Throughput (Letters Per Minute)

- Up to 65 letters per minute

Actual throughput varies, depending on the material used, device condition, use of moistener, etc.

## Ink Cartridge Life

- 35 ml cartridge - yields up to 3,000 impressions. (Actual ink yields vary with usage and environmental conditions).

## Ports

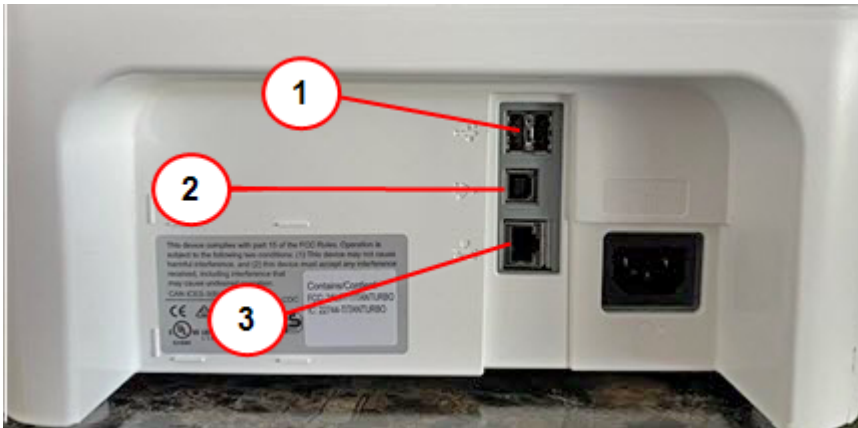

1. **USB port type A host** - Connect a Barcode scanner or external scale to these ports.
2. **USB port, type B host** - Service personnel use only.
3. **RJ45** - Use for a wired network connection.

## Display

7-inch tablet (169 pixels/inch)

## Print Resolution

300 H x 600 V dpi

## Print Image Area

25.4 mm x 180 mm

## Tapes and Strips

Self-adhesive, dual tape strip for use on mailpieces that are too large to run in the device. Ideal for adding postage to oversized envelopes, priority mail and packages.

## Graphics

Up to 20 graphic ads on the device.

## Material specifications

Review the material specifications including the minimum and maximum envelope sizes, envelope stack height, and tape size details.

### Envelope Size

- Minimum: 76 x 120 mm
- Maximum: 330 x 381 mm

### Envelope Flap Depth

- 72.2 mm

### Envelope Thickness

- Minimum: 0.20 mm
- Maximum: 8 mm

### Stack Height for Mail

- 76.2 mm – This is the height of the inner edge of the side guide

### Envelope Weight

- Minimum: 1 g
- Maximum: 450 g

### Tape Size

- Minimum: 44.2 x 100 mm
- Maximum: 44.7 x 200 mm



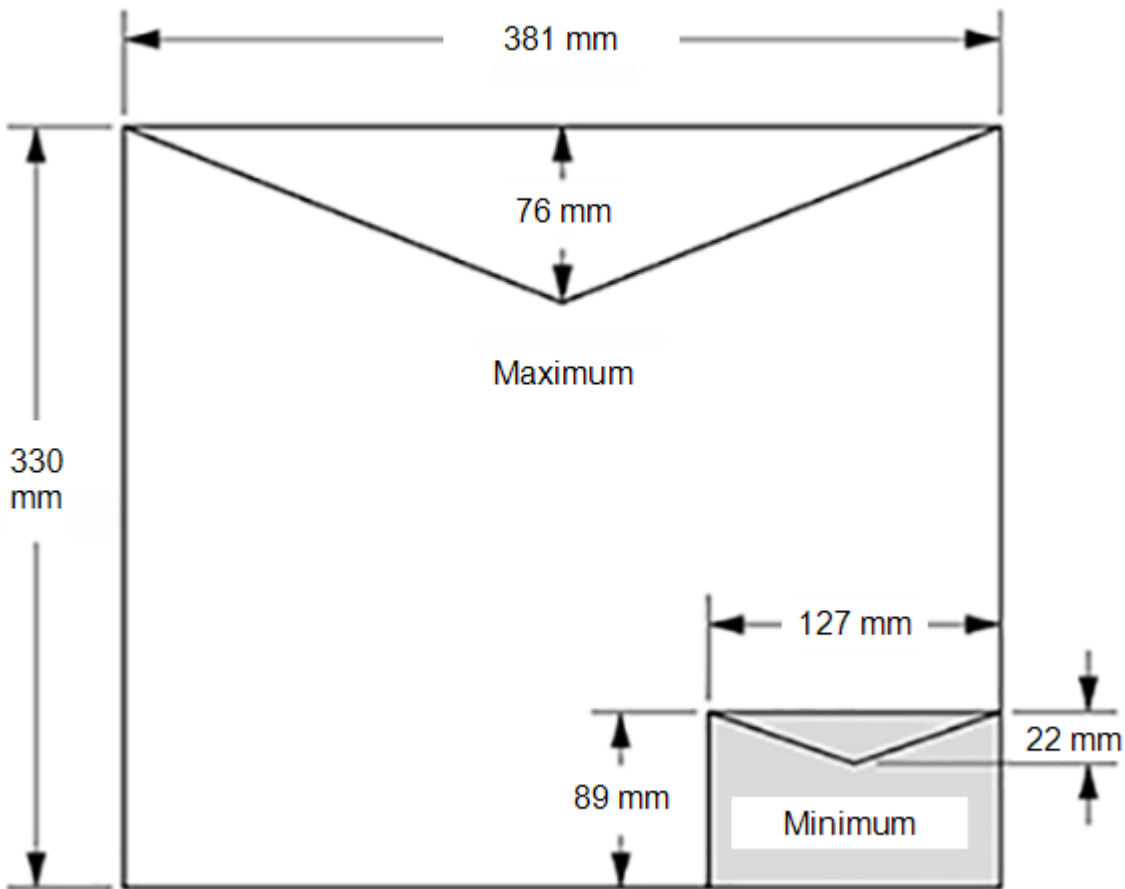

For a proper seal, the envelope's minimum flap angle must meet the following criteria:

- For envelopes with a flap length from 25-60 mm, the minimum flap angle is 18 degrees.
- For envelopes with a flap length greater than 60 mm to the maximum flap length for the particular model, the minimum flap angle is 21 degrees.

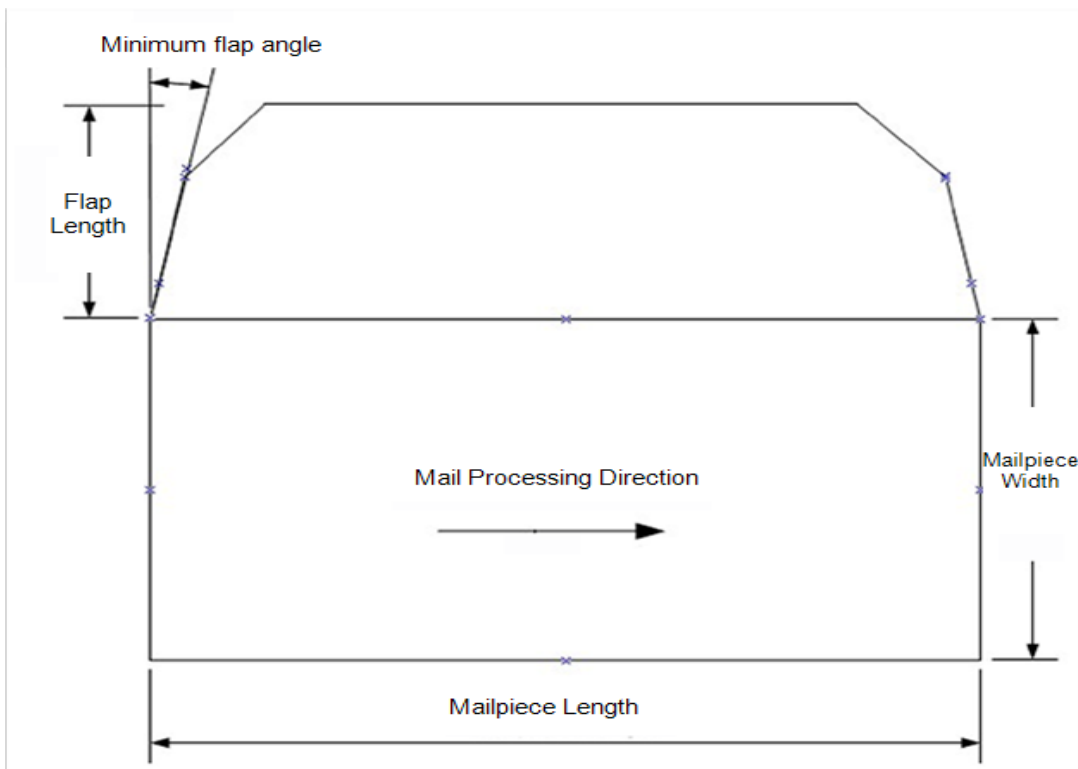

## Moving the SendPro C, SendPro+

Move your device safely, whether you are moving it across the room or to a new facility.

1. If you have a scale, remove it from the device.
2. Remove the moistener assembly. Once you have removed and cleaned the assembly, place it in a zip-top bag to prevent any remaining fluid from leaking.
3. Remove the ink cartridge. Once you get the ink cartridge out, place it in a zip-top bag.
4. Close the top cover.
5. Remove all USB cables and optional peripherals such as scanners. Pack them with the device.
6. Unplug the power cord and pack it with the device.
7. Once in the new location, re-install all USB cables and peripherals.
8. Plug the power cord into the device and power outlet.
9. Re-install the ink cartridge.
10. Re-install the moistener assembly.

## Important safety notes

Visit [pitneybowes.com/uk/support](https://www.pitneybowes.com/uk/support) for the latest product documentation.

Follow the normal safety precautions for all office equipment.

- Please read all instructions before you attempt to operate the system. Save these instructions for future use.
- Use only Pitney Bowes approved supplies, in particular aerosol dusters. Improper storage and use of aerosol dusters or flammable aerosol dusters can cause an explosive-like condition that could result in personal injury and / or property damage. Never use aerosol dusters labelled flammable and always read instructions and safety precautions on the duster label.
- To obtain supplies, please contact our Supply Line™ to place orders.
- Material Safety Data Sheets can be obtained through the web or from our Supply Line™.
- Use the power cord supplied with the machine and plug it into a properly grounded wall outlet located near the machine and easily accessible. Failure to properly ground the machine can result in severe personal injury and / or fire.
- Avoid touching moving parts or materials while the machine is in use. Keep hands, loose clothing, jewellery and long hair away from all moving parts.
- Do not remove covers or defeat safety interlock switches. Covers enclose hazardous parts that should only be accessed by properly trained service personnel. Immediately report to service any damaged or non-functioning components that renders the unit unsafe.
- Place the unit in an accessible location to allow for proper venting of the equipment and to facilitate servicing.
- The power cord wall plug is the primary means of disconnecting the machine from the AC supply.
- If the unit becomes damaged unplug the power cord from the wall.
- Do not use an adapter plug on the line cord or wall outlet.
- Do not remove the ground pin from the line cord.
- Do not use wall outlets that are controlled by wall switches and avoid sharing an outlet with other equipment.
- Do not route the power cord over sharp edges or trap between furniture.
- Ensure there is no strain on the power cord and that it does not become jammed between the equipment, walls or furniture.
- Be certain the area in front of the wall receptacle into which the machine is plugged is free from obstruction.
- Before clearing a stoppage, be sure machine mechanisms come to a stop.
- When removing stalled material, avoid using too much force to protect against minor personal injury and damaging equipment.
- To prevent overheating, do not cover any vent openings.
- Operation of this equipment without periodic maintenance will inhibit optimum operating performance and could cause the equipment to malfunction. Contact your machine supplier for required service schedule.
- Read all instructions before attempting to operate the equipment. Use this equipment only for its intended purpose.
- Always follow the specific occupational safety and health standards for your workplace.

- This product contains a lithium ion battery. The battery must be recycled or disposed of properly. If you are leasing this product, you must return it to Pitney Bowes. Alternatively, contact your local waste disposal or recycle facility for instructions on how to dispose of it properly.
- This equipment contains a Radio Frequency Transmitter operating at 2.4 or 5 GHZ ISM band.

## Contacting Pitney Bowes

### Your device information

Always have the following information before contacting Pitney Bowes Technical Support:

- **Product Name:** SendPro C, SendPro+
- **PCN and serial number:** Check the label under the front cover of the device.
- **Problem Description:**
  - What is happening and when.
  - Are there any error messages?
- **Attempts to fix:**
  - What have you already tried to fix the problem?
  - If you tried, what happened?

### Technical and Account Support:

Visit our website at:

<https://www.pitneybowes.com/uk/support>

### Pitney Bowes Supply Line

Visit our website at:

<https://www.pitneybowes.co.uk/shop/home/en-uk/storeuk>

Customer service representatives are available 9 am to 5 pm, Mon-Fri excluding public holidays.

## Third party software

Third party software may have been incorporated into this product by Pitney Bowes Inc. (“PBI”) under permission from PBI’s licensors. Any special terms and conditions that apply to such software are provided below:

This product contains the following software:

- Okhttp3 which is licensed under the Apache License, Version number 2.0. The license can be downloaded from: <http://www.apache.org/licenses/LICENSE-2.0.html>. The source code for this software is available from <http://square.github.io/okhttp/>.
- Retrofit which is licensed under the Apache License, Version number 2.0. The license can be downloaded from: <http://www.apache.org/licenses/LICENSE-2.0.html>. The source code for this software is available from <https://square.github.io/retrofit/>.
- Okio which is licensed under the Apache License, Version number 2.0. The license can be downloaded from: <https://github.com/square/okio/blob/master/LICENSE.txt>. The source code for this software is available from <https://github.com/square/okio>.
- Commons-codec which is licensed under the Apache License, Version number 2.0. The license can be downloaded from: <http://www.apache.org/licenses/LICENSE-2.0.html>. The source code for this software is available from [https://commons.apache.org/proper/commons-codec/download\\_codec.cgi](https://commons.apache.org/proper/commons-codec/download_codec.cgi).
- Commons-io which is licensed under the Apache License, Version number 2.0. The license can be downloaded from: <http://www.apache.org/licenses/LICENSE-2.0.html>. The source code for this software is available from [https://commons.apache.org/proper/commons-io/download\\_io.cgi](https://commons.apache.org/proper/commons-io/download_io.cgi).
- Org.greenrobot:eventbus which is licensed under the Apache License, Version number 2.0. The license can be downloaded from: <http://www.apache.org/licenses/LICENSE-2.0.html>. The source code for this software is available from <http://greenrobot.org>.
- Org.greenrobot:greendao which is licensed under the Apache License, Version number 2.0. The license can be downloaded from: <http://www.apache.org/licenses/LICENSE-2.0.html>. The source code for this software is available from <http://greenrobot.org/greendao>.
- FasterXml.jackson.core:jackson-core which is licensed under the Apache License, Version number 2.0. The license can be downloaded from: <http://wiki.fasterxml.com/JacksonLicensing>. The source code for this software is available from <http://wiki.fasterxml.com>.
- Aws-android-sdk-core which is licensed under the Apache License, Version number 2.0. The license can be downloaded from: <https://github.com/aws/aws-sdk-android/blob/master/LICENSE.APACHE.txt>. The source code for this software is available from <https://github.com/aws/aws-sdk-android>.
- Aws-android-sdk-iot which is licensed under the Apache License, Version number 2.0. The license can be downloaded from: <https://github.com/aws/aws-sdk-android/blob/master/LICENSE.APACHE.txt>. The source code for this software is available from <https://github.com/aws/aws-sdk-android>.

- `Aws-android-sdk-s3` which is licensed under the Apache License, Version number 2.0. The license can be downloaded from: <https://github.com/aws/aws-sdk-android/blob/master/LICENSE.APACHE.txt>. The source code for this software is available from <https://github.com/aws/aws-sdk-android>.
- `Nv-websocket-client` which is licensed under the Apache License, Version number 2.0. The license can be downloaded from: <http://www.apache.org/licenses/LICENSE-2.0.html>. The source code for this software is available from <https://github.com/TakahikoKawasaki/nv-websocket-client>.
- `bumptech.glide` which is licensed under the Apache License, Version number 2.0. The license can be downloaded from: <http://www.apache.org/licenses/LICENSE-2.0.html>. The source code for this software is available from <https://github.com/bumptech/glide>.
- `Jakewharton:butterknife` which is licensed under the Apache License, Version number 2.0. The license can be downloaded from: <http://www.apache.org/licenses/LICENSE-2.0.html>. The source code for this software is available from <https://github.com/JakeWharton/butterknife>.
- `Caverock:androidsvg` which is licensed under the Apache License, Version number 2.0. The license can be downloaded from: <http://www.apache.org/licenses/LICENSE-2.0.html>. The source code for this software is available from <https://mvnrepository.com/artifact/com.caverock/androidsvg/1.2.1>.
- `Glassfish:javafx.annotation` which is dual licensed under the CDDL, Version 1.0, and the GNU General Public License, Version 2, June 1991, with the Classpath Exception. The licenses can be downloaded from: <https://javaee.github.io/glassfish/LICENSE>. The source code for this software is available from <https://javaee.github.io/glassfish>.
- `CalligraphyXamarin` which is licensed under the Apache License, Version number 2.0. The license can be downloaded from: <http://www.apache.org/licenses/LICENSE-2.0.html>. The source code for this software is available from <https://github.com/mikescandy/Calligraphy-xamarin>.
- `Newtonsoft.JSON.NET` which is licensed under the MIT License. The license can be downloaded from: <https://github.com/JamesNK/Newtonsoft.Json>. The source code for this software is available from <https://github.com/JamesNK/Newtonsoft.Json>.
- `MaterialChips` which is licensed under the Apache License, Version number 2.0. The license can be downloaded from: <http://www.apache.org/licenses/LICENSE-2.0.html>. The source code for this software is available from <https://github.com/DoodleScheduling/android-material-chips>.
- `Android Open Source Project ("AOSP")`, which is licensed under the Apache License, Version number 2.0. The license can be downloaded from: <http://www.apache.org/licenses/LICENSE-2.0.html>. AOSP also contains the Linux kernel which is licensed under GNU General Public License, Version 2, June 1991 ("GPL"). The license can be downloaded from: <http://www.gnu.org/licenses/gpl-2.0.html> Copyright © 1989, 1991 Free Software Foundation. For up to three years from PBI's distribution of this product, you may obtain a complete machine-readable copy of the source code for the Linux kernel under the terms of the GPL, without charge except for the cost of the media, shipping, and handling, upon written request to PBI. Such requests should be sent by e-mail to [iptl@pb.com](mailto:iptl@pb.com).

- This product contains Paho.mqtt.java, which is licensed under the Eclipse Public License - v 2.0 and the Eclipse Distribution License - v 1.0. The licenses can be downloaded from <https://www.eclipse.org/legal/epl-2.0/> and <https://www.eclipse.org/org/documents/edl-v10.php>, respectively. The modified source code can be downloaded from: <https://github.com/PitneyBowes>.



3001 Summer Street  
Stamford, Connecticut 06926  
[www.pitneybowes.com](http://www.pitneybowes.com)

PB Form SV63242-gb Rev.F  
© Pitney Bowes Limited, 2022  
We have made every reasonable effort to assure the accuracy and usefulness of this guide, however we cannot assume responsibility for errors or omissions or liability for the misuse or misapplication of our products.