



Shipping & Mailing
Shipping Label Printer

PitneyShip™ Cube

AX00

User Guide

US English Edition
SV63411 Rev. A
June 16, 2023

©2023 Pitney Bowes Inc.

All rights reserved. This book may not be reproduced in whole or in part in any fashion or stored in a retrieval system of any type or transmitted by any means, electronically or mechanically, without the express written permission of Pitney Bowes.

The use of this information by the recipient or others for purposes other than the training of customers on Pitney Bowes equipment may constitute an infringement of intellectual property rights of Pitney Bowes, and Pitney Bowes assumes no responsibility for any such use of the information.

We have made every reasonable effort to ensure the accuracy and usefulness of this manual. However, we cannot assume responsibility for errors or omissions or liability for the misuse or misapplication of our products.

Except as provided in writing, duly signed by an officer of Pitney Bowes, no license either express or implied, under any Pitney Bowes or third party's patent, copyright or other intellectual property rights is granted by providing this information.

PB Postage™ is a trademark of Pitney Bowes Inc.

The PitneyShip Cube User Guide is designed to assist in the daily operations of the printer and scale. Use this book as a reference, as it includes system operating procedures.

Version History

Document Part Number	Release Date	Comments
SV63411 Rev. A	June 16, 2023	First release of guide.

Other Resources

Visit the Pitney Bowes support site for other resources that may be helpful when working with the PitneyShip Cube.

<https://www.pitneybowes.com/us/support/products/pitneyship-cube-support.html>

Table of Contents

1 - Installation

Installing your PitneyShip Cube	8
Installing PitneyShip Cube on a Windows PC using a USB connection (new user)	9
Installing PitneyShip Cube on a Windows PC using a wireless connection (new user)	15
Installing PitneyShip Cube on a Windows PC using a USB connection (existing user)	22
Installing PitneyShip Cube on a Windows PC using a wireless connection (existing user)	28
Installing PitneyShip Cube on a Mac using a USB connection (new user)	34
Installing PitneyShip Cube on a Mac using a wireless connection (new user)	40
Installing PitneyShip Cube on a Mac using a USB connection (existing user)	46
Installing PitneyShip Cube on a Mac using a wireless connection (existing user)	52
Installing PitneyShip Cube on a mobile device (new user)	58
Installing PitneyShip Cube on a mobile device (existing user)	64

2 - Connectivity

Reconnecting your PitneyShip Cube to the PitneyShip mobile app	71
--	----

3 - Downloads and Drivers

Installing the PitneyShip Cube driver on an additional computer	74
---	----

4 - Feeding and Jamming

Clearing a label jam on the PitneyShip Cube	78
---	----

5 - Maintenance

Changing the label roll on the PitneyShip Cube	80
--	----

6 - Printing

Printing a test label using the PitneyShip Cube with the PitneyShip mobile app	82
--	----

7 - Product Information

Understanding your printer LED light codes for the PitneyShip Cube	84
--	----

8 - Scales and Weighing

Using the PitneyShip Cube scale with the PitneyShip mobile app	87
Zeroing the scale on the PitneyShip Cube	87

9 - PitneyShip mobile app

Installing the PitneyShip mobile app App	89
Refilling postage in the PitneyShip mobile app	89
Creating a Shipping Label in the PitneyShip mobile app	90
Importing an address using your mobile device camera in PitneyShip Mobile	92
Adding an Address to the Address Book in the PitneyShip mobile app	92
Editing an Address in the PitneyShip mobile app	93
Deleting an Address from the Address Book in the PitneyShip mobile app	93
Tracking a Shipment in the PitneyShip mobile app	94
Connecting your Amazon store to the PitneyShip mobile app	94
Connecting your eBay store to the PitneyShip mobile app	95

Connecting your Shopify store to the PitneyShip mobile app	96
Changing your PitneyShip subscription using the PitneyShip mobile app	97

10 - Safety

Important Safety and Compliance Information for Your Printer and Scale	99
--	----

1 - Installation

In this section

Installing your PitneyShip Cube	8
Installing PitneyShip Cube on a Windows PC using a USB connection (new user)	9
Installing PitneyShip Cube on a Windows PC using a wireless connection (new user)	15
Installing PitneyShip Cube on a Windows PC using a USB connection (existing user)	22
Installing PitneyShip Cube on a Windows PC using a wireless connection (existing user)	28
Installing PitneyShip Cube on a Mac using a USB connection (new user)	34
Installing PitneyShip Cube on a Mac using a wireless connection (new user)	40
Installing PitneyShip Cube on a Mac using a USB connection (existing user)	46
Installing PitneyShip Cube on a Mac using a wireless connection (existing user)	52
Installing PitneyShip Cube on a mobile device (new user)	58
Installing PitneyShip Cube on a mobile device (existing user)	64

Installing your PitneyShip Cube

Your PitneyShip Cube can be installed on a Windows PC, Mac, and mobile device. If you are connecting your PitneyShip Cube to a Windows PC or a Mac, you are given the option to connect via USB cable or Wi-Fi. If you are connecting your PitneyShip Cube to a mobile device, you will connect using Wi-Fi. Select an installation article below to see detailed step-by-step instructions for your preferred installation.

- [Installing your PitneyShip Cube using a PC](#)
- [Installing your PitneyShip Cube using a Mac](#)
- [Installing your PitneyShip Cube using your mobile device](#)

Installing your PitneyShip Cube using a PC

If you are new to PitneyShip, select your preferred connection method:

- [Installing PitneyShip Cube on a Windows PC using a USB connection as a new PitneyShip user](#)
- [Installing PitneyShip Cube on a Windows PC using a wireless connection as a new PitneyShip user](#)

If you are an existing PitneyShip user, select your preferred connection method:

- [Installing PitneyShip Cube on a Windows PC using a USB connection as an existing PitneyShip user](#)
- [Installing PitneyShip Cube on a Windows PC using a wireless connection as an existing PitneyShip user](#)

Installing your PitneyShip Cube using a Mac

If you are new to PitneyShip, select your preferred connection method:

- [Installing PitneyShip Cube on a Mac using a USB connection as a new PitneyShip user](#)
- [Installing PitneyShip Cube on a Mac using a wireless connection as a new PitneyShip user](#)

If you are an existing PitneyShip, select your preferred connection method:

- [Installing PitneyShip Cube on a Mac using a USB connection as an existing PitneyShip user](#)
- [Installing PitneyShip Cube on a Mac using a wireless connection as an existing PitneyShip user](#)

Installing your PitneyShip Cube using your mobile device

- [Installing PitneyShip Cube on a mobile device as a new PitneyShip user](#)
- [Installing PitneyShip Cube on a mobile device as an existing PitneyShip user](#)

Installing PitneyShip Cube on a Windows PC using a USB connection (new user)

These instructions will guide you through a first-time installation of your PitneyShip Cube on a Windows PC as a new PitneyShip user. These instructions are for users wanting to connect their PitneyShip Cube using a wired USB cable connection.

1. [Opening the box and unpacking](#)
2. [Creating your PitneyShip account](#)
3. [Connecting your PitneyShip Cube](#)
4. [Performing a test print](#)

1

Opening the box and unpacking

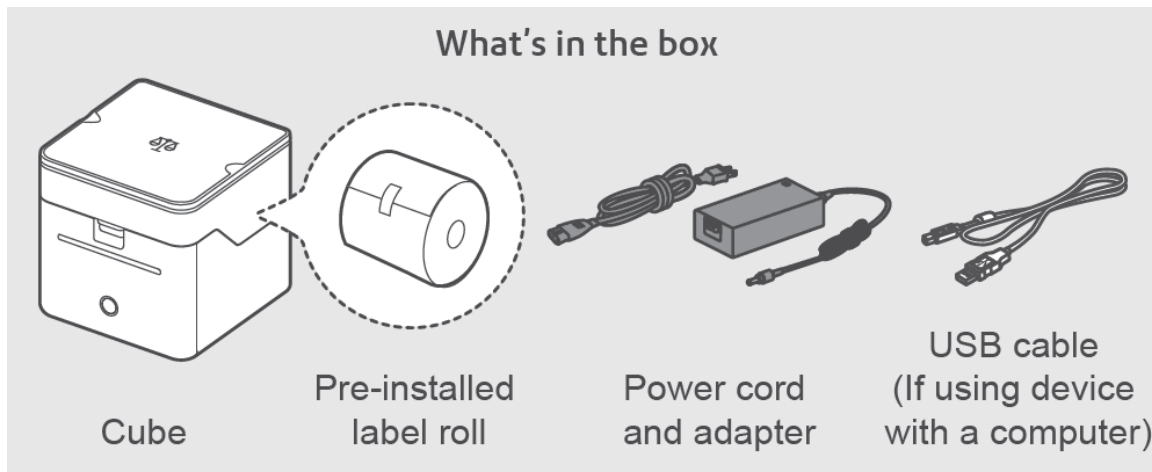

1. Unpack the device and remove the protective scale spacers.

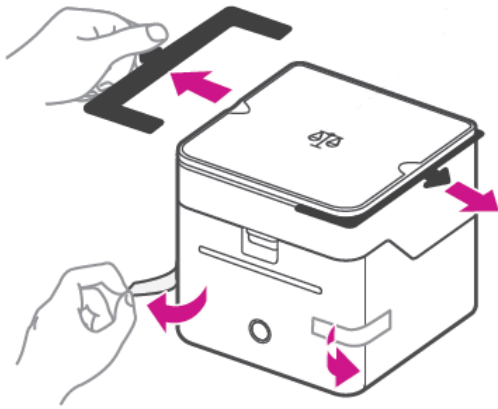

2. Feed the label roll into the slot.
 - a. Open the label roll cover.

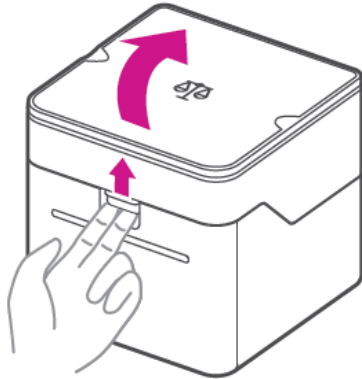

- b. Remove the protective sheet and the tape from the label roll.

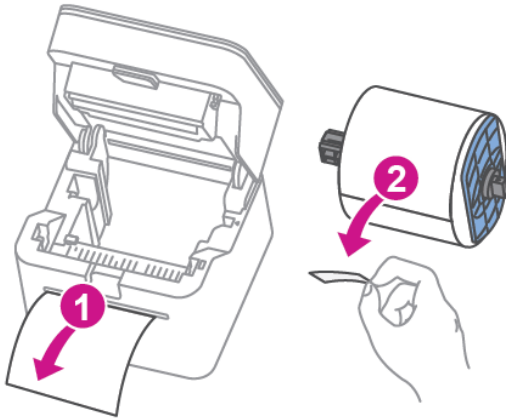

- c. Feed the label roll through the slot, and close the cover.

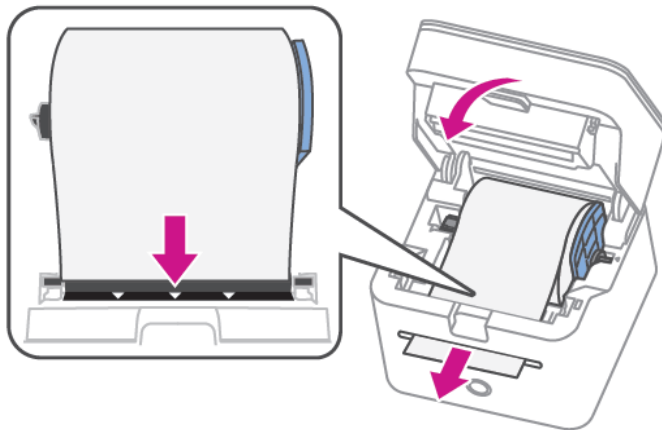

3. Connect the device to a power source and press the power button. The LED will light up orange and then change to flashing white until your PitneyShip Cube is connected.

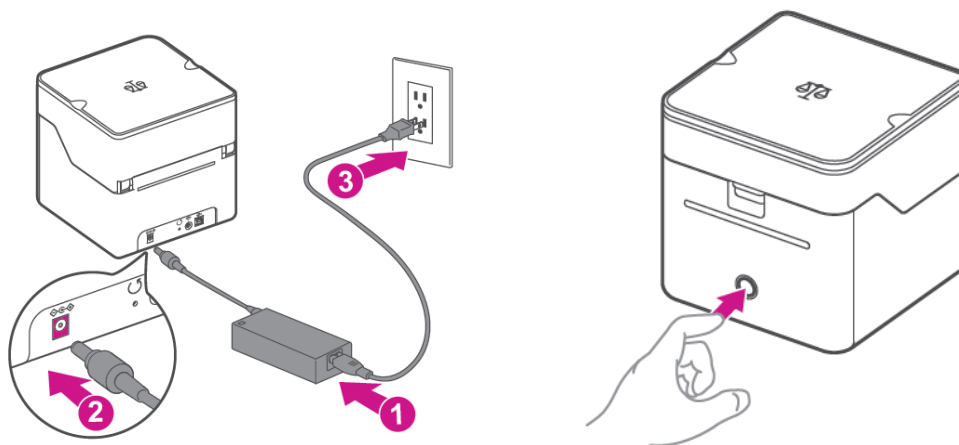

4. Set up and complete the installation using PitneyShip.

2 Creating your PitneyShip account

1. Go to cube.pitneybowes.com.
2. Click **Get Started**.
3. Enter your email address, then click **Next**.
4. The system will recognize you as a new PitneyShip user. Review the 30-day trial, then click **Next**.
5. Select your PitneyShip plan and click **Next**.
6. Fill in your account details.
7. Fill in your legal business name. If you do not have a legal business name, tap the **I am the sole proprietor without a legal business name** check box.

LEGAL BUSINESS NAME

I am the sole proprietor without a legal business name. ⓘ

BUSINESS ADDRESS

8. Fill in your business address fields.
9. Click **Create Account**.

10. Your PitneyShip account creation is complete. Click **Next**.
11. Enter the password you created and click **Sign In**.
12. Click **Get Started**.

3

Connecting your PitneyShip Cube

1. Connect the USB cable to your printer and your PC.

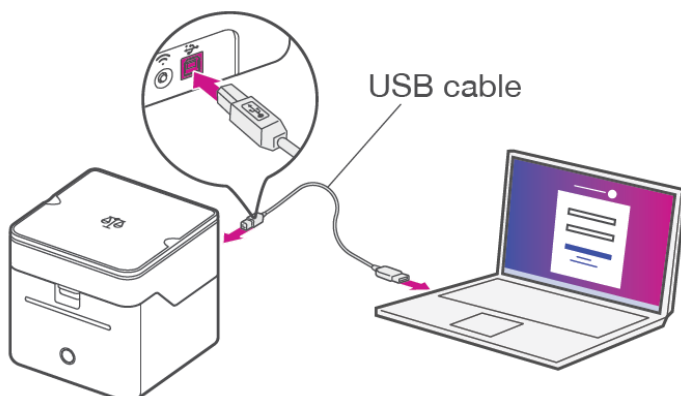

2. When asked, "How do you want to connect your PitneyShip Cube?" select **With USB**.
3. Review the **Before installing** prompt and click **Next**.

Before installing:

Make sure you satisfy the following requirements:

1. You have admin access to install the drivers. If not, contact your system administrator.
2. PitneyShip Cube is turned ON and the light in front of the printer is solid white.



Next

4. Click **Download PitneyShip Cube Driver**.
 - a. Once the download is complete, go to your **Downloads** folder, or your designated page for downloads, and double-click the **PB_Printer_and_Scale_driver.exe** file. This will open the installer. If you are unable to find the file, click **downloading again**.
 - b. Review the license agreement and select "**I accept the terms in the license agreement**", and click **Next**.
 - c. Click **Finish** to start the installation process. The Seagull Driver Wizard will open.
 - d. Select **Install Print Drivers** and click **Next**.
 - e. Select **USB** and click **Next**.
 - f. Select **Install a driver for a Plug and Play printer** and click **Next**.
 - g. Click **Next**.
 - h. Click **Finish**.
 - i. Once the installation is complete, click **Close**.
5. Once the driver is installed, go to **Printers and Scanners** on your computer. Click **Yes** to confirm that your PitneyShip Cube has been added to your printer list.
6. Click **Download DeviceHub**.
 - a. Once the download is complete, go to your **Downloads** folder, or your designated page for downloads, and double-click the **DeviceHubXX.XX.X.exe** file. This will open the installer.
 - b. Click **Install**.
 - c. Once the installation is complete, click **Finish** to close the installer.
 - d. On your computer, check the Systems tray at the bottom of your desktop and find the DeviceHub icon. Click **Yes** to confirm that DeviceHub was successfully installed.
 - e. Click **Activate DeviceHub**. A new tab will open.
 - f. Once DeviceHub activation is successful, close the tab.
7. Click **Continue PitneyShip Cube Setup**.
8. Confirm your location and click **Next**.

Performing a test print

1. Click **Print** to perform a test print.
2. Tap **No** if the test print was unsuccessful. Then, tap **Print Again**. If the second test print was unsuccessful, please contact us using the contact options.
3. Tap **Yes** if your test print was successful.
4. Tap **Get Started**. PitneyShip will now set up your experience. This could take a few minutes to complete.

Your PitneyShip Cube setup is now complete.

Installing PitneyShip Cube on a Windows PC using a wireless connection (new user)

These instructions will guide you through a first-time installation of your PitneyShip Cube on a Windows PC as a new PitneyShip user. These instructions are for users wanting to connect their PitneyShip Cube using a Wi-Fi connection. Before you begin your installation, you will need your mobile device to establish a Wi-Fi connection. .

1. [Opening the box and unpacking](#)
2. [Creating your PitneyShip account](#)
3. [Connecting your PitneyShip Cube](#)
4. [Performing a test print](#)

1

Opening the box and unpacking

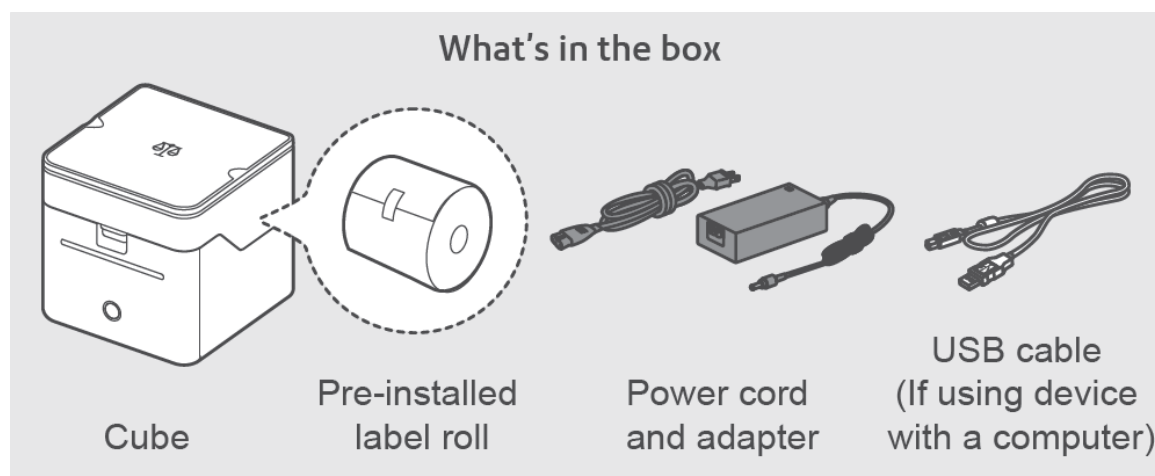

1. Unpack the device and remove the protective scale spacers.

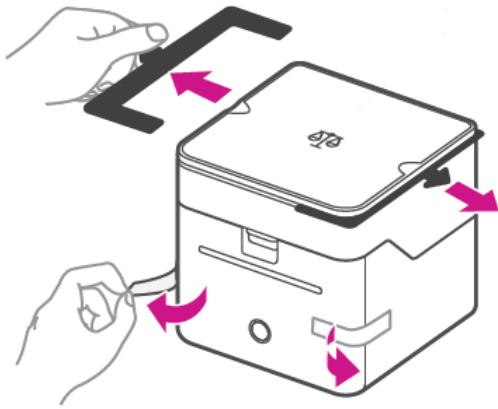

2. Feed the label roll into the slot.
 - a. Open the label roll cover.

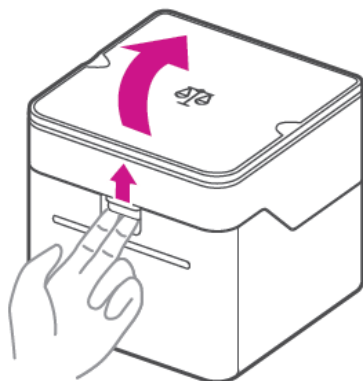

- b. Remove the protective sheet and the tape from the label roll.

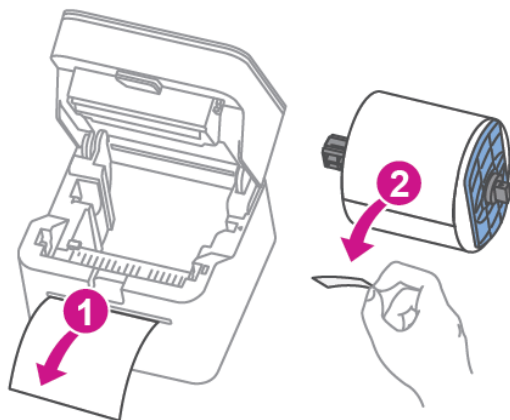

- c. Feed the label roll through the slot, and close the cover.

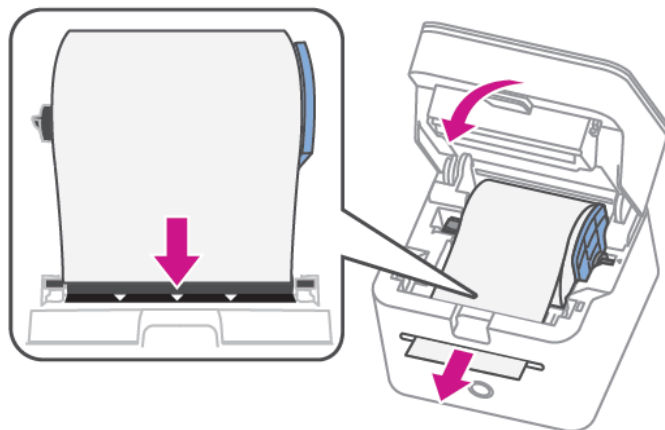

3. Connect the device to a power source and press the power button. The LED will light up orange and then change to flashing white until your PitneyShip Cube is connected.

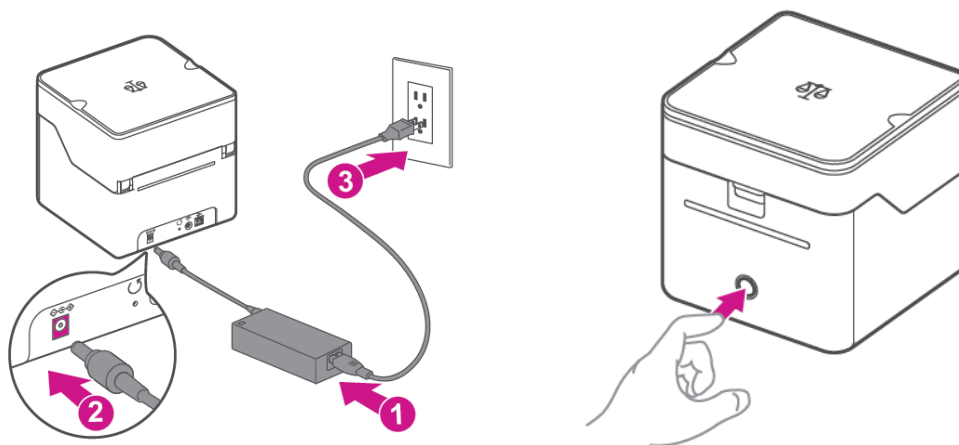

4. Set up and complete the installation using PitneyShip.

2 Creating your PitneyShip account

1. Go to cube.pitneybowes.com.
2. Click **Get Started**.
3. Enter your email address, then click **Next**.
4. The system will recognize you as a new PitneyShip user. Review the 30-day trial, then click **Next**.
5. Select your PitneyShip plan and click **Next**.
6. Fill in your account details.
7. Fill in your legal business name. If you do not have a legal business name, tap the **I am the sole proprietor without a legal business name** check box.

LEGAL BUSINESS NAME

I am the sole proprietor without a legal business name. ⓘ

BUSINESS ADDRESS

8. Fill in your business address fields.
9. Click **Create Account**.

10. Your PitneyShip account creation is complete. Click **Next**.
11. Enter the password you created and click **Sign In**.
12. Click **Get Started**.

3

Connecting your PitneyShip Cube

1. When asked, "How do you want to connect your PitneyShip Cube?" select **With wi-fi**.
2. If you have previously connected your PitneyShip Cube to your phone, click **Yes**. If you have not connected your PitneyShip Cube to your phone, click **No**. You must connect your PitneyShip Cube to your phone before you can connect it wirelessly to your computer. To connect your PitneyShip Cube to your phone:
 - a. Download the PitneyShip mobile app. Scan the QR code below, or search for **PitneyShip - Ship and Track** in your app store.



- b. Log in using your PitneyShip account email and password.
- c. On the home page, tap **Connect now**.



PitneyShip™

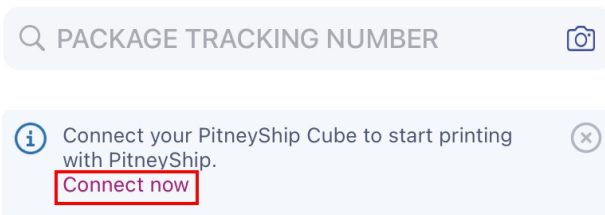

- d. Tap **Yes** if your PitneyShip Cube has a slow blinking light. If your PitneyShip Cube has a fast blinking light, or is showing a different LED color, tap **No**.
- e. Review the app permissions and tap **Next**.
- f. Tap **Join** to connect the PitneyShip mobile app to the PitneyShip Cube Wi-Fi network.
- g. Select your Wi-Fi network and enter your Wi-Fi password. If you do not see a list of Wi-Fi networks, tap **Refresh list** and select your Wi-Fi network.
- h. Your PitneyShip Cube is now connected to your network. Tap **Next**.
- i. Close the PitneyShip mobile app and return to your computer to continue the installation.
- j. Click **Next**.

- Review the **Before installing** prompt and click **Next**.

Before installing:

Make sure you satisfy the following requirements:

- You have admin access to install the drivers. If not, contact your system administrator.
- PitneyShip Cube is turned ON and the light in front of the printer is solid white.

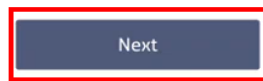

- Click **Download PitneyShip Cube Driver**.
- Once the download is complete, go to your **Downloads** folder, or your designated page for downloads, and double-click the **NetworkAutoInstaller.exe** file. This will open the installer.
- Click **Yes** on the User account control permissions pop-up.
- Select the installation location and click **Next**. The installation will start.
- The Pitney Bowes NetworkAutoInstaller will open. Click **Search**.

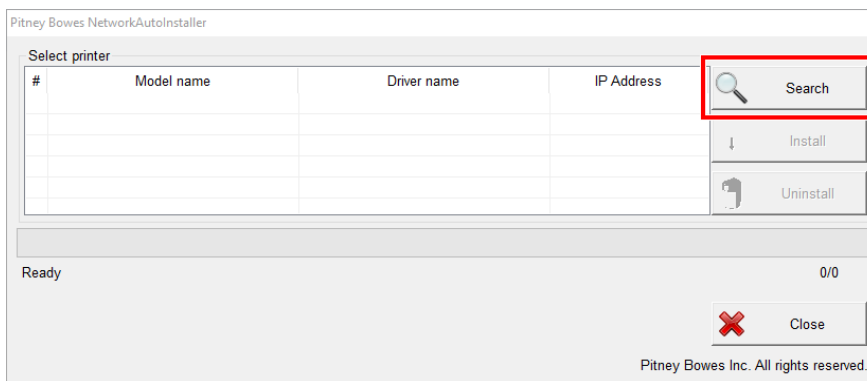

- Select Pitney Bowes Printer and Scale and click **Install**.
- Once the installation is complete, you will see the driver name updated to PitneyBowes Printer and Scale. Click **Close** to complete the installation.
- Go to **Printers and Scanners** on your computer. Click **Yes** to confirm that your PitneyShip Cube has been added to your printer list.

12. Click Download **DeviceHub**.
 - a. Once the download is complete, go to your **Downloads** folder, or your designated page for downloads, and double-click the **DeviceHubXX.XX.X.exe** file. This will open the installer.
 - b. Click **Install**.
 - c. Once the installation is complete, click **Finish** to close the installer.
13. On your computer, check the Systems tray at the bottom of your desktop and find the DeviceHub icon. Click **Yes** to confirm that DeviceHub was successfully installed.
14. Click **Activate DeviceHub**. A new tab will open.
15. Once DeviceHub activation is successful, close the tab.
16. Click **Continue PitneyShip Cube Setup**.
17. Confirm your location and click **Next**.

4 Performing a test print

1. Click **Print** to perform a test print.
2. Tap **No** if the test print was unsuccessful. Then, tap **Print Again**. If the second test print was unsuccessful, please contact us using the contact options.
3. Tap **Yes** if your test print was successful.
4. Tap **Get Started**. PitneyShip will now set up your experience. This could take a few minutes to complete.

Your PitneyShip Cube setup is now complete.

Installing PitneyShip Cube on a Windows PC using a USB connection (existing user)

These instructions will guide you through a first-time installation of your PitneyShip Cube on a Windows PC as an existing PitneyShip user. These instructions are for users wanting to connect their PitneyShip Cube using a wired USB cable connection.

1. [Opening the box and unpacking](#)
2. [Logging in to your PitneyShip account](#)
3. [Connecting your PitneyShip Cube](#)
4. [Performing a test print](#)

1

Opening the box and unpacking

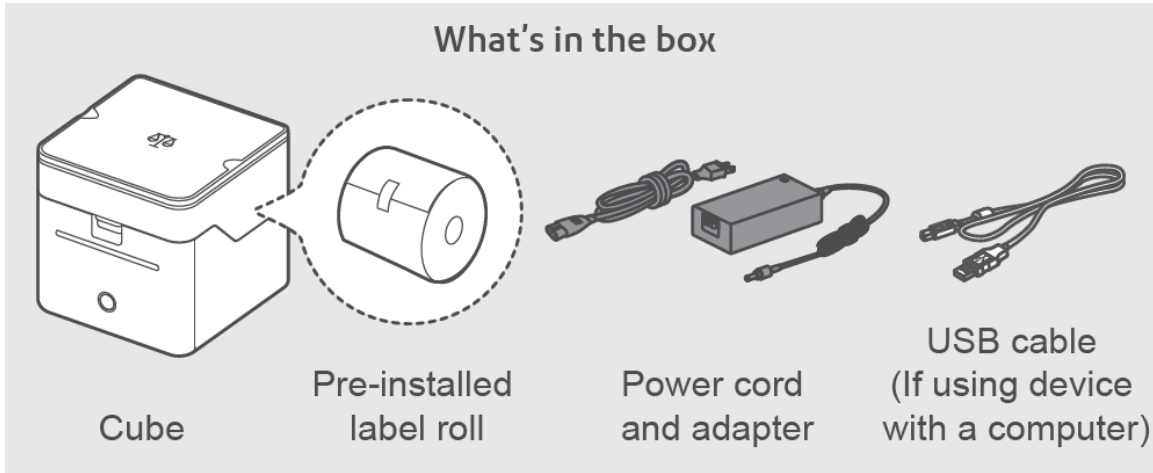

1. Unpack the device and remove the protective scale spacers.

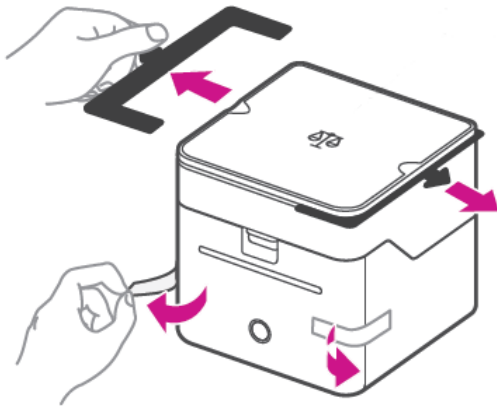

2. Feed the label roll into the slot.
 - a. Open the label roll cover.

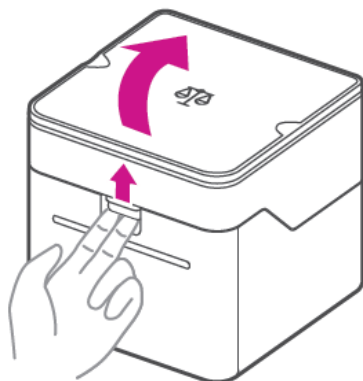

- b. Remove the protective sheet and the tape from the label roll.

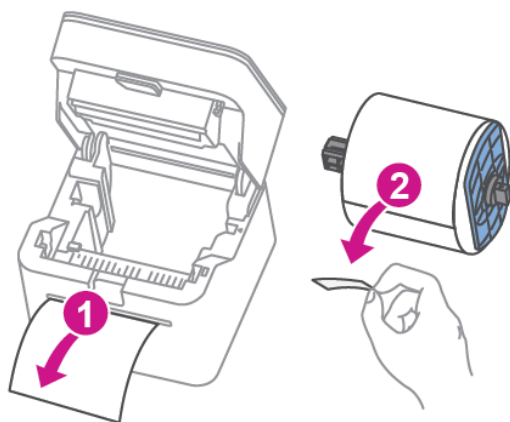

- c. Feed the label roll through the slot and close the cover.

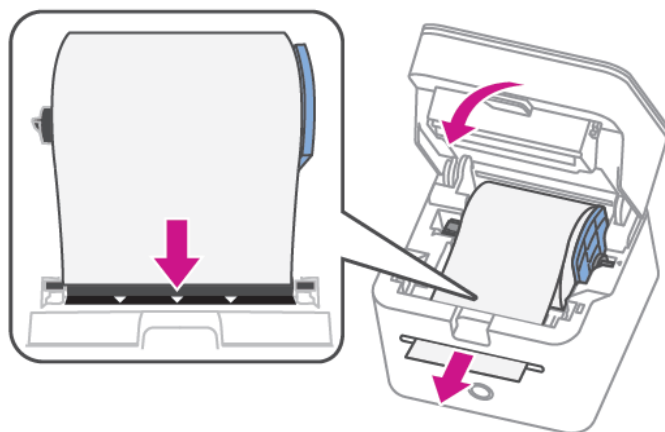

3. Connect the device to a power source and press the power button. The LED will light up orange and then change to flashing white until your PitneyShip Cube is connected.

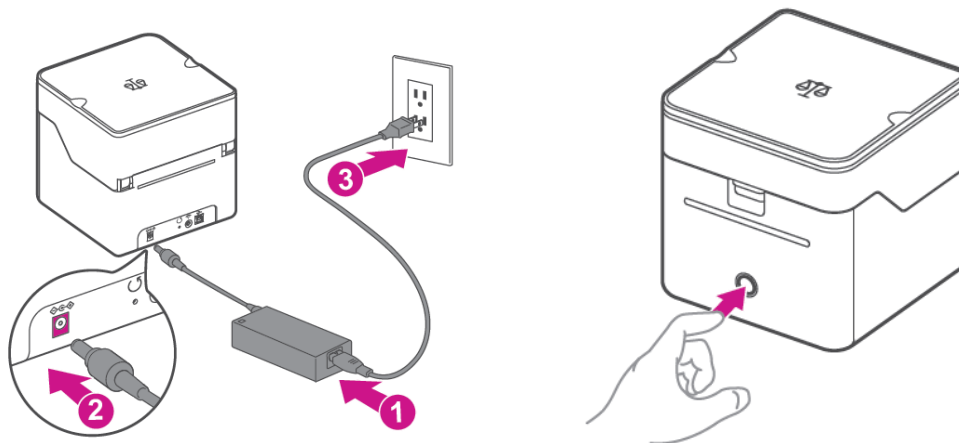

4. Set up and complete installation using PitneyShip.

2

Logging in to your PitneyShip account

1. Go to cube.pitneybowes.com.
2. Click **Sign in**. You will be redirected to the login screen.
3. Enter your email address and password and click **Sign In**.
4. Click on **Get Started** to begin your PitneyShip Cube installation.

3

Connecting your PitneyShip Cube

1. Connect the USB cable to your printer and your PC.

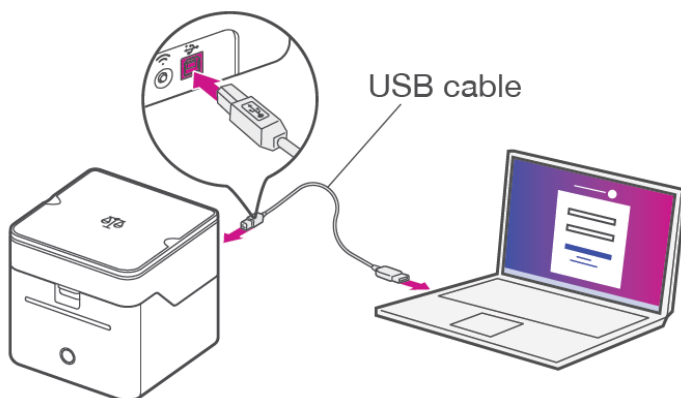

2. When asked, "How do you want to connect your PitneyShip Cube?" select **With USB**.
3. Review the **Before installing** prompt and click **Next**.

Before installing:

Make sure you satisfy the following requirements:

1. You have admin access to install the drivers. If not, contact your system administrator.
2. PitneyShip Cube is turned ON and the light in front of the printer is solid white.



Next

4. Click **Download PitneyShip Cube Driver**.
 - a. Once the download is complete, go to your **Downloads** folder, or your designated page for downloads, and double-click the **PB_Printer_and_Scale_driver.exe** file. This will open the installer. If you are unable to find the file, click **downloading again**.
 - b. Review the license agreement and select "**I accept the terms in the license agreement**", and click **Next**.
 - c. Click **Finish** to start the installation process. The Seagull Driver Wizard will open.
 - d. Select **Install Print Drivers** and click **Next**.
 - e. Select **USB** and click **Next**.
 - f. Select **Install a driver for a Plug and Play printer** and click **Next**.
 - g. Click **Next**.
 - h. Click **Finish**.
 - i. Once the installation is complete, click **Close**.
5. Once the driver is installed, go to **Printers and Scanners** on your computer. Click **Yes** to confirm that your PitneyShip Cube has been added to your printer list.
6. Click **Download DeviceHub**.
 - a. Once the download is complete, go to your **Downloads** folder, or your designated page for downloads, and double-click the **DeviceHubXX.XX.X.exe** file. This will open the installer.
 - b. Click **Install**.
 - c. Once the installation is complete, click **Finish** to close the installer.
 - d. On your computer, check the Systems tray at the bottom of your desktop and find the DeviceHub icon. Click **Yes** to confirm that DeviceHub was successfully installed.
 - e. Click **Activate DeviceHub**. A new tab will open.
 - f. Once DeviceHub activation is successful, close the tab.
7. Click **Continue PitneyShip Cube Setup**.
8. Confirm your location and click **Next**.

4 Performing a test print

1. Click **Print** to perform a test print.
2. Tap **No** if the test print was unsuccessful. Then, tap **Print Again**. If the second test print was unsuccessful, please contact us using the contact options.
3. Tap **Yes** if your test print was successful.
4. Tap **Get Started**. PitneyShip will now set up your experience. This could take a few minutes to complete.

Your PitneyShip Cube setup is now complete.

Installing PitneyShip Cube on a Windows PC using a wireless connection (existing user)

These instructions will guide you through a first-time installation of your PitneyShip Cube on a Windows PC as an existing PitneyShip user. These instructions are for users wanting to connect their PitneyShip Cube using a Wi-Fi connection. Before you begin your installation, you will need your mobile device to establish a Wi-Fi connection. .

1. [Opening the box and unpacking](#)
2. [Logging in to your PitneyShip account](#)
3. [Connecting your PitneyShip Cube](#)
4. [Performing a test print](#)

1

Opening the box and unpacking

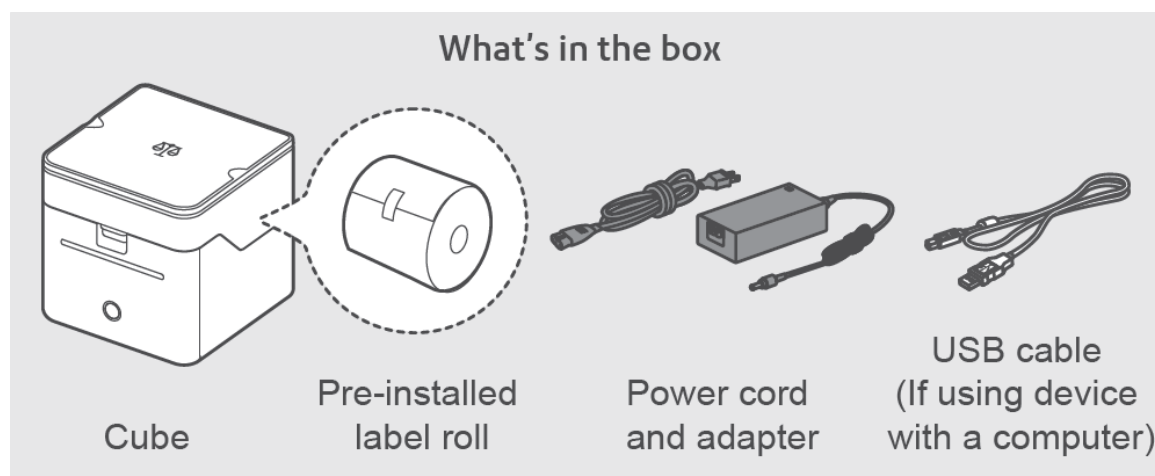

1. Unpack the device and remove the protective scale spacers.

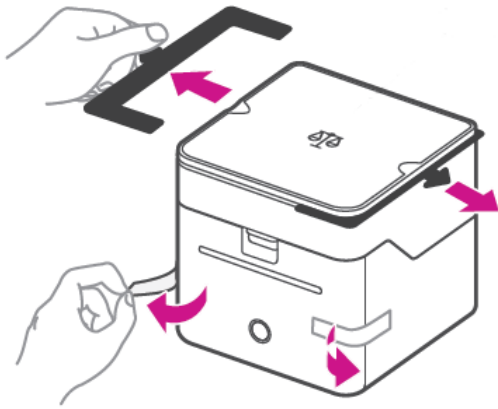

2. Feed the label roll into the slot.
 - a. Open the label roll cover.



- b. Remove the protective sheet and the tape from the label roll.

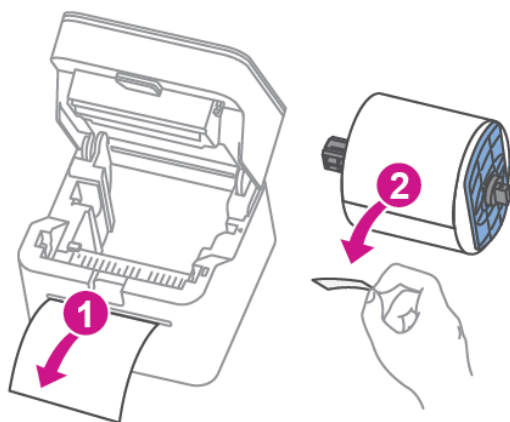

- c. Feed the label roll through the slot and close the cover.

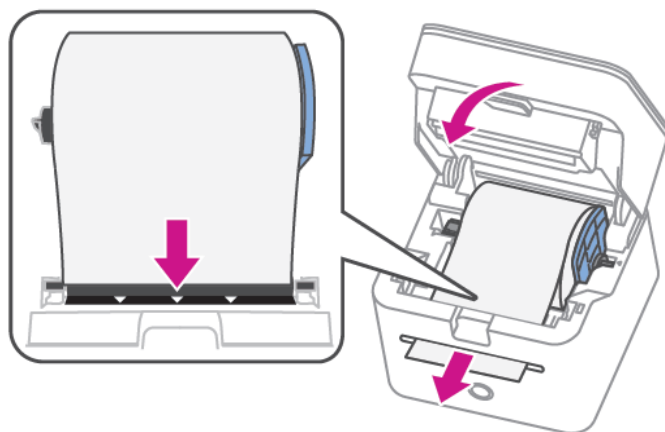

3. Connect the device to a power source and press the power button. The LED will light up orange and then change to flashing white until your PitneyShip Cube is connected.

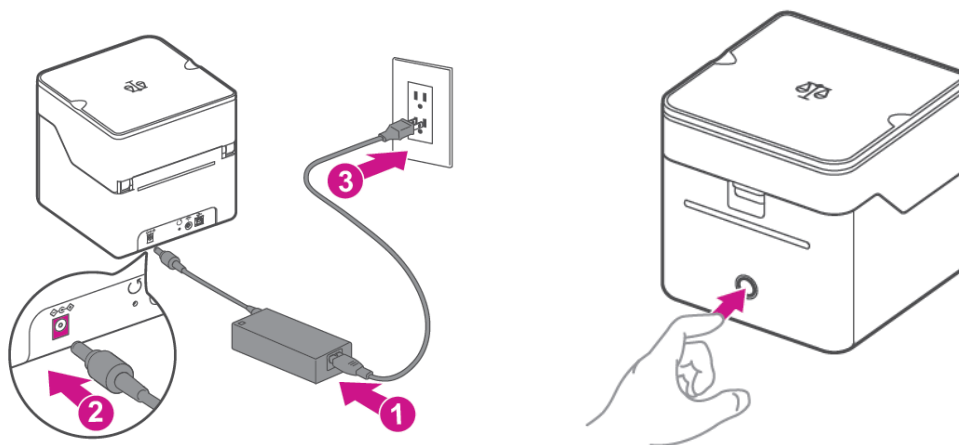

4. Set up and complete installation using PitneyShip.

2

Logging in to your PitneyShip account

1. Go to cube.pitneybowes.com.
2. Click **Sign in**. You will be redirected to the login screen.
3. Enter your email address and password and click **Sign In**.
4. Click on **Get Started** to begin your PitneyShip Cube installation.

3

Connecting your PitneyShip Cube

1. When asked, "How do you want to connect your PitneyShip Cube?" select **With wi-fi**.
2. If you have previously connected your PitneyShip Cube to your phone, click **Yes**. If you have not connected your PitneyShip Cube to your phone, click **No**. You must connect your PitneyShip Cube to your phone before you can connect it wirelessly to your computer. To connect your PitneyShip Cube to your phone:
 - a. Download the PitneyShip mobile app. Scan the QR code below, or search for **PitneyShip - Ship and Track** in your app store.



- b. Log in using your PitneyShip account email and password.
- c. On the home page, tap **Connect now**.



PitneyShip™

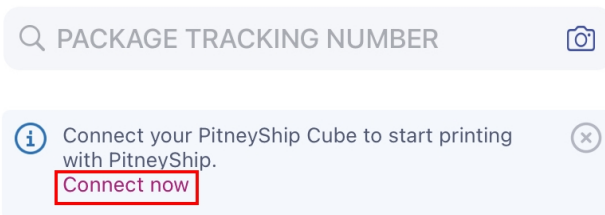

- d. Tap **Yes** if your PitneyShip Cube has a slow blinking light. If your PitneyShip Cube has a fast blinking light, or is showing a different LED color, tap **No**.
- e. Review the app permissions and tap **Next**.
- f. Tap **Join** to connect the PitneyShip mobile app to the PitneyShip Cube Wi-Fi network.
- g. Select your Wi-Fi network and enter your Wi-Fi password. If you do not see a list of Wi-Fi networks, tap **Refresh list** and select your Wi-Fi network.
- h. Your PitneyShip Cube is now connected to your network. Tap **Next**.
- i. Close the PitneyShip mobile app and return to your computer to continue the installation.
- j. Click **Next**.

- Review the **Before installing** prompt and click **Next**.

Before installing:

Make sure you satisfy the following requirements:

- You have admin access to install the drivers. If not, contact your system administrator.
- PitneyShip Cube is turned ON and the light in front of the printer is solid white.



- Click **Download PitneyShip Cube Driver**.
- Once the download is complete, go to your **Downloads** folder, or your designated page for downloads, and double-click the **NetworkAutoInstaller.exe** file. This will open the installer.
- Click **Yes** on the User account control permissions pop-up.
- Select the installation location and click **Next**. The installation will start.
- The Pitney Bowes NetworkAutoInstaller will open. Click **Search**.

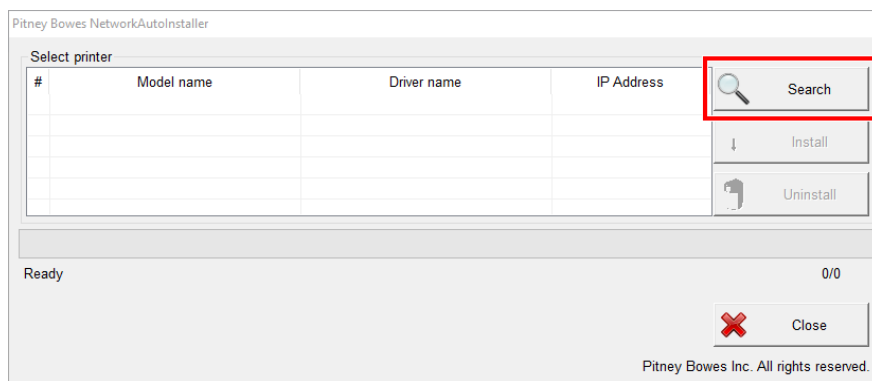

- Select Pitney Bowes Printer and Scale and click **Install**.
- Once the installation is complete, you will see the driver name updated to PitneyBowes Printer and Scale. Click **Close** to complete the installation.
- Go to **Printers and Scanners** on your computer. Click **Yes** to confirm that your PitneyShip Cube has been added to your printer list.

12. Click Download **DeviceHub**.
 - a. Once the download is complete, go to your **Downloads** folder, or your designated page for downloads, and double-click the **DeviceHubXX.XX.X.exe** file. This will open the installer.
 - b. Click **Install**.
 - c. Once the installation is complete, click **Finish** to close the installer.
13. On your computer, check the Systems tray at the bottom of your desktop and find the DeviceHub icon. Click **Yes** to confirm that DeviceHub was successfully installed.
14. Click **Activate DeviceHub**. A new tab will open.
15. Once DeviceHub activation is successful, close the tab.
16. Click **Continue PitneyShip Cube Setup**.
17. Confirm your location and click **Next**.

4 Performing a test print

1. Click **Print** to perform a test print.
2. Tap **No** if the test print was unsuccessful. Then, tap **Print Again**. If the second test print was unsuccessful, please contact us using the contact options.
3. Tap **Yes** if your test print was successful.
4. Tap **Get Started**. PitneyShip will now set up your experience. This could take a few minutes to complete.

Your PitneyShip Cube setup is now complete.

Installing PitneyShip Cube on a Mac using a USB connection (new user)

These instructions will guide you through a first-time installation of your PitneyShip Cube on a Mac device as an existing PitneyShip user. These instructions are for users wanting to connect their PitneyShip Cube using a wired USB cable connection.

1. [Opening the box and unpacking](#)
2. [Creating your PitneyShip account](#)
3. [Connecting your PitneyShip Cube](#)
4. [Performing a test print](#)

1

Opening the box and unpacking

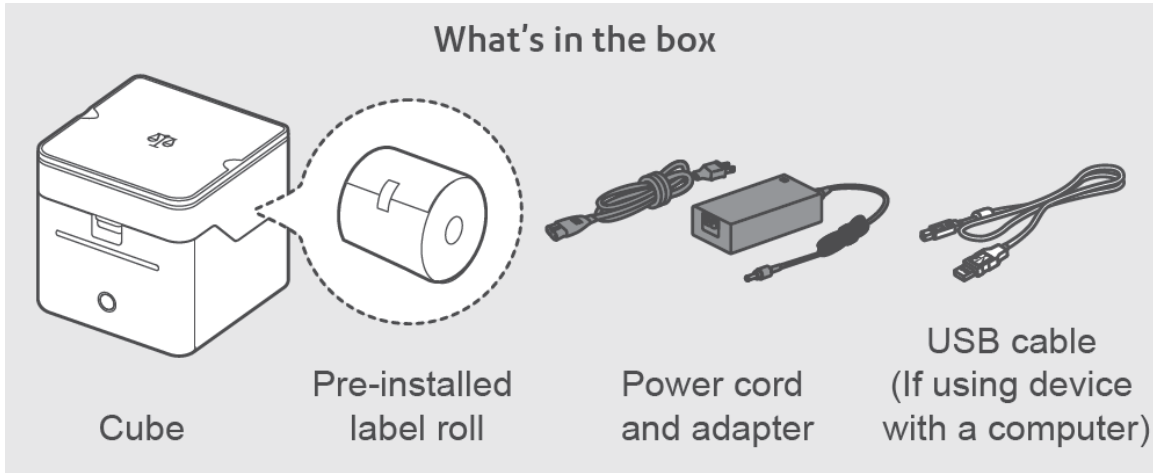

1. Unpack the device and remove the protective scale spacers.

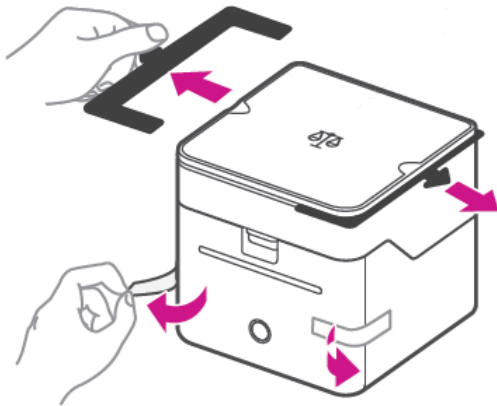

2. Feed the label roll into the slot.
 - a. Open the label roll cover.

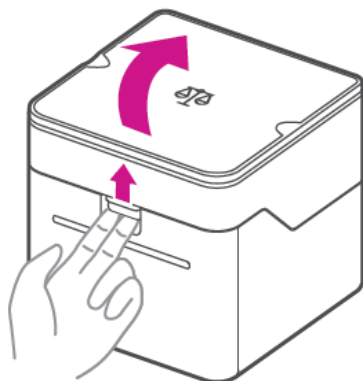

- b. Remove the protective sheet and the tape from the label roll.

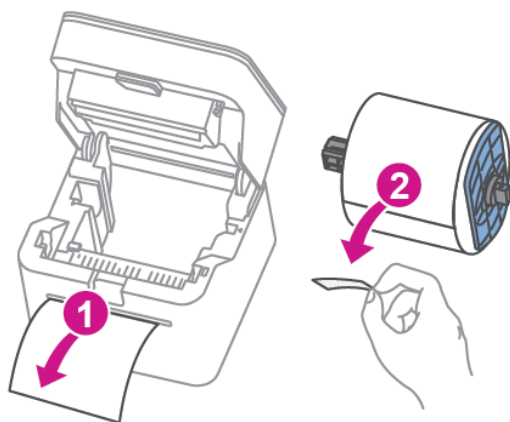

- c. Feed the label roll through the slot, and close the cover.

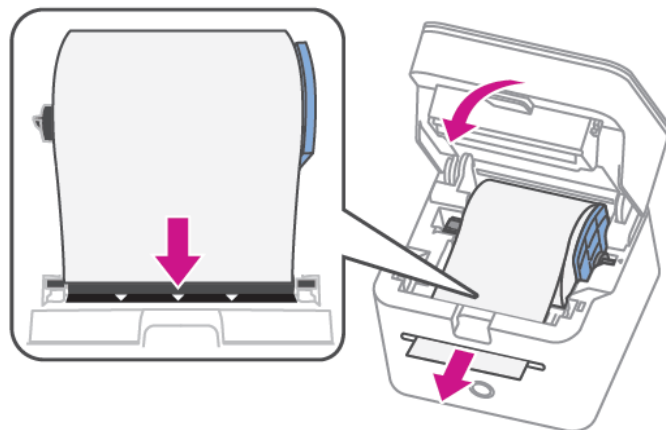

3. Connect the device to a power source and press the power button. The LED will light up orange and then change to flashing white until your PitneyShip Cube is connected.

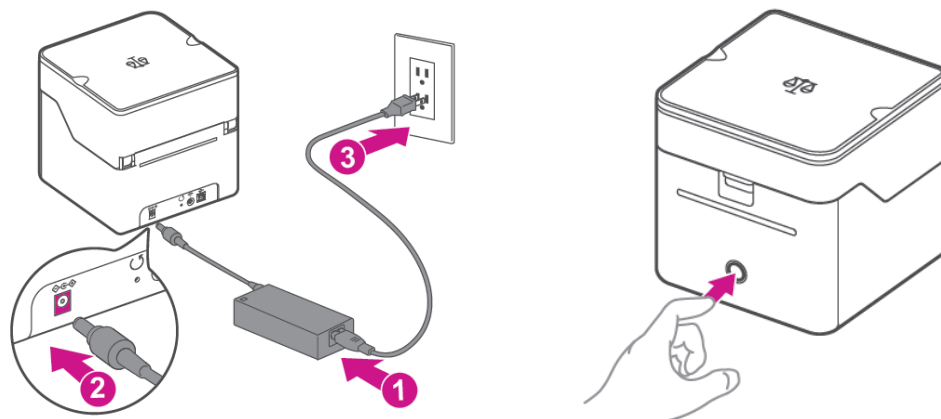

4. Set up and complete the installation using PitneyShip.

2 Creating your PitneyShip account

1. Go to cube.pitneybowes.com.
2. Click **Get Started**.
3. Enter your email address, then click **Next**.
4. The system will recognize you as a new PitneyShip user. Review the 30-day trial, then click **Next**.
5. Select your PitneyShip plan and click **Next**.
6. Fill in your account details.
7. Fill in your legal business name. If you do not have a legal business name, tap the **I am the sole proprietor without a legal business name** check box.

LEGAL BUSINESS NAME

I am the sole proprietor without a legal business name. ⓘ

BUSINESS ADDRESS

8. Fill in your business address fields.
9. Click **Create Account**.
10. Your PitneyShip account creation is complete. Click **Next** to set up your PitneyShip Cube.

3

Connecting your PitneyShip Cube

1. When asked, "How do you want to connect your PitneyShip Cube?" select **With USB**.
2. Review the **Before installing** prompt and click **Next**.

Before installing:

Make sure you satisfy the following requirements:

1. You have admin access to install the drivers. If not, contact your system administrator.
2. PitneyShip Cube is turned ON and the light in front of the printer is solid white.



Next

3. Click **Download PitneyShip Cube Driver**.
 - a. Once the download is complete, go to the **PB_Printer_and_Scale_driver** installer.
 - b. Click **Continue**.
 - c. Click **Install**.
 - d. If prompted, enter your Mac password and click **Install Software**.
 - e. When the installation is complete, click **Close**.
 - f. Connect the USB cable to your printer and your computer.

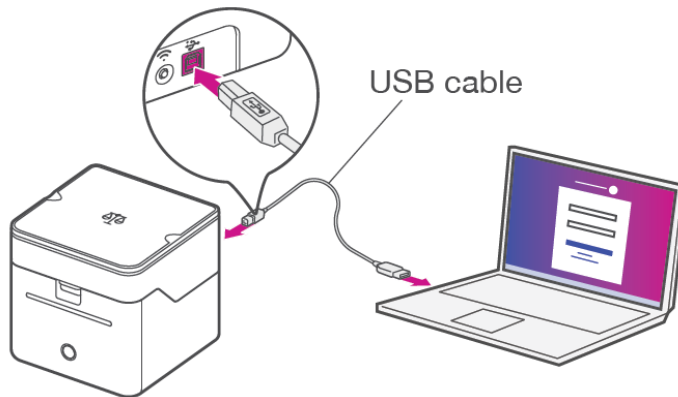

- g. On your computer, select **Finder > Applications > System Preferences > Printers and Scanners**.
 - h. Click **Yes** to confirm that your PitneyShip Cube has been added to your printer list.
4. Click **Download DeviceHub**.
 - a. Once the download is complete, double-click the **DeviceHubXX.XX.X** file. This will open the installer.
 - b. Click **Install**.
 - c. If prompted, enter your Mac password and click **Install Software**.
 - d. Once the installation is complete, click **Close** to close the installer.
 - e. On your computer, check the Menu bar at the top of your desktop screen and find the DeviceHub icon. Click **Yes** to confirm that DeviceHub was successfully installed.
 - f. Click **Activate DeviceHub**. A new tab will open.
 - g. Once DeviceHub activation is successful, close the tab.
5. Click **Continue PitneyShip Cube Setup**.
6. Confirm your location and click **Next**.

4

Performing a test print

1. Click **Print** to perform a test print.
2. Tap **No** if the test print was unsuccessful. Then, tap **Print Again**. If the second test print was unsuccessful, please contact us using the contact options.
3. Tap **Yes** if your test print was successful.
4. Tap **Get Started**. PitneyShip will now set up your experience. This could take a few minutes to complete.

Your PitneyShip Cube setup is now complete.

Installing PitneyShip Cube on a Mac using a wireless connection (new user)

These instructions will guide you through a first-time installation of your PitneyShip Cube on a Mac device as a new PitneyShip user. These instructions are for users wanting to connect their PitneyShip Cube using a Wi-Fi connection. Before you begin your installation, you will need your mobile device to establish a Wi-Fi connection. .

1. [*Opening the box and unpacking*](#)
2. [*Creating your PitneyShip account*](#)
3. [*Connecting your PitneyShip Cube*](#)
4. [*Performing a test print*](#)

1

Opening the box and unpacking

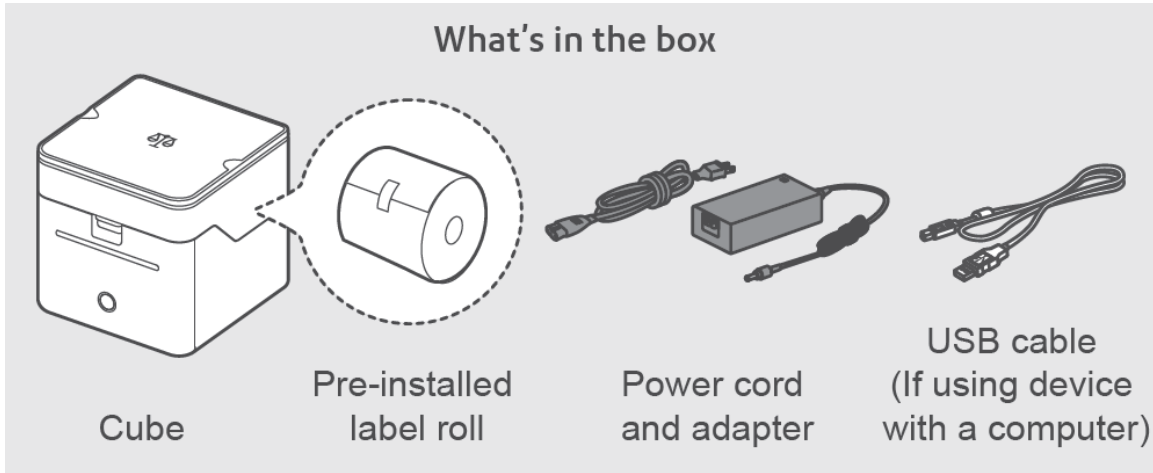

1. Unpack the device and remove the protective scale spacers.

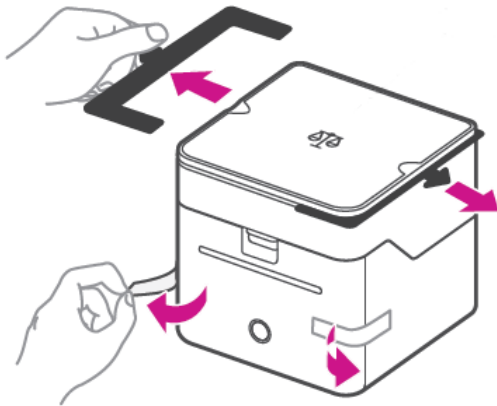

2. Feed the label roll into the slot.
 - a. Open the label roll cover.

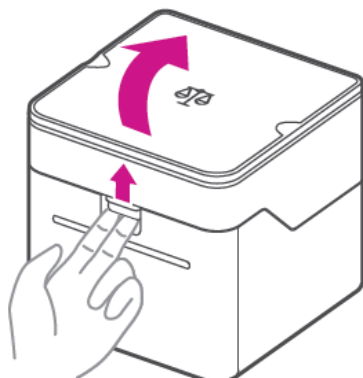

- b. Remove the protective sheet and the tape from the label roll.

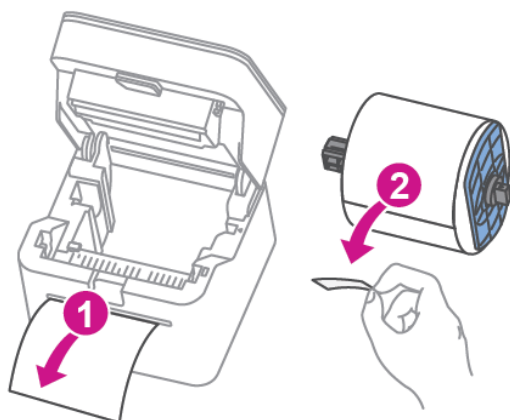

- c. Feed the label roll through the slot, and close the cover.

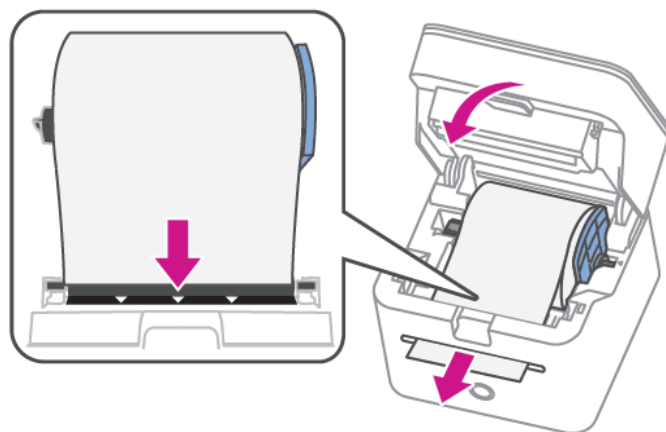

3. Connect the device to a power source and press the power button. The LED will light up orange and then change to flashing white until your PitneyShip Cube is connected.

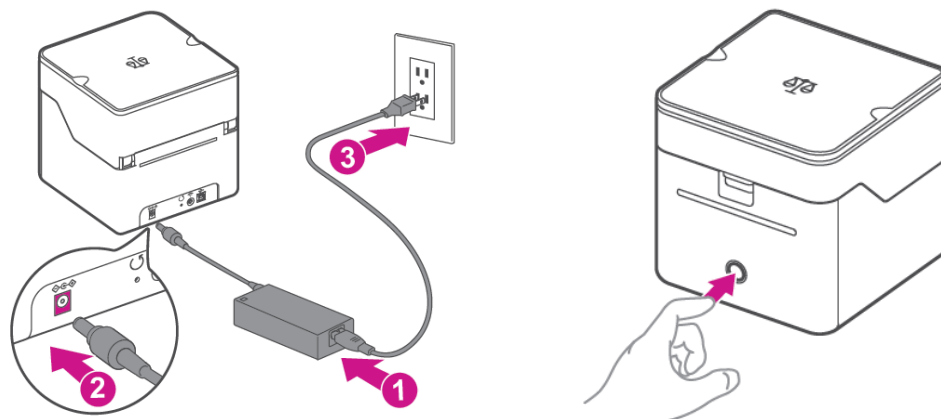

4. Set up and complete the installation using PitneyShip.

2 Creating your PitneyShip account

1. Go to cube.pitneybowes.com.
2. Click **Get Started**.
3. Enter your email address, then click **Next**.
4. The system will recognize you as a new PitneyShip user. Review the 30-day trial, then click **Next**.
5. Select your PitneyShip plan and click **Next**.
6. Fill in your account details.
7. Fill in your legal business name. If you do not have a legal business name, tap the **I am the sole proprietor without a legal business name** check box.

LEGAL BUSINESS NAME

I am the sole proprietor without a legal business name. ⓘ

BUSINESS ADDRESS

8. Fill in your business address fields.
9. Click **Create Account**.
10. Your PitneyShip account creation is complete. Click **Next** to set up your PitneyShip Cube.

3

Connecting your PitneyShip Cube

1. When asked, "How do you want to connect your PitneyShip Cube?" select **With wi-fi**.
2. If you have previously connected your PitneyShip Cube to your phone, click **Yes**. If you have not connected your PitneyShip Cube to your phone, click **No**. You must connect your PitneyShip Cube to your phone before you can connect it wirelessly to your computer. To connect your PitneyShip Cube to your phone:
 - a. Download the PitneyShip mobile app. Scan the QR code below, or search for **PitneyShip - Ship and Track** in your phone's app store.



- b. Log in using your PitneyShip account email and password.
- c. On the home page, tap **Connect now**.



PitneyShip™

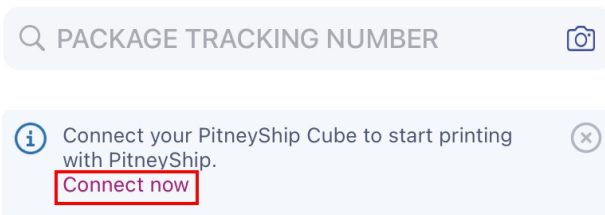

- d. Tap **Yes** if your PitneyShip Cube has a slow blinking light. If your PitneyShip Cube has a fast blinking light, or is showing a different LED color, tap **No**.
- e. Review the app permissions and tap **Next**.
- f. Tap **Join** to connect the PitneyShip mobile app to the PitneyShip Cube Wi-Fi network.
- g. Select your Wi-Fi network and enter your Wi-Fi password. If you do not see a list of Wi-Fi networks, tap **Refresh list** and select your Wi-Fi network.
- h. Your PitneyShip Cube is now connected to your network. Tap **Next**.
- i. Close the PitneyShip mobile app and return to your computer to continue the installation.
- j. Click **Next**.

3. Review the **Before installing** prompt and click **Next**.

Before installing:

Make sure you satisfy the following requirements:

1. You have admin access to install the drivers. If not, contact your system administrator.
2. PitneyShip Cube is turned ON and the light in front of the printer is solid white.

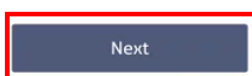

4. Click **Download PitneyShip Cube Driver**.
 - a. Once the download is complete, go to the **PB_Printer_and_Scale_driver** installer.
 - b. Click **Continue**.
 - c. Click **Install**.
 - d. If prompted, enter your Mac password and click **Install Software**.
 - e. When the installation is complete, click **Close**.
 - f. On your computer, select **Finder > Applications > System Preferences > Printers and Scanners**.
 - g. Click the **+** icon on the bottom left panel.
 - h. Select **Bixelon Printer and Scale**.
 - i. Click the **Use** drop down and select **Select Software**.

- j. Select **PitneyBowes Printer and Scale** and click **OK**.
 - k. Click **Add**.
 - l. Click **Yes** to confirm that your PitneyShip Cube has been added to your printer list.

5. Click Download **DeviceHub**.
 - a. Once the download is complete, double-click the **DeviceHubXX.XX.X** file. This will open the installer.
 - b. Click **Install**.
 - c. If prompted, enter your Mac password and click **Install Software**.
 - d. Once the installation is complete, click **Close** to close the installer.
 - e. On your computer, check the Menu bar at the top of your desktop screen and find the DeviceHub icon. Click **Yes** to confirm that DeviceHub was successfully installed.
 - f. Click **Activate DeviceHub**. A new tab will open.
 - g. Once DeviceHub activation is successful, close the tab.
6. Click **Continue PitneyShip Cube Setup**.
7. Confirm your location and click **Next**.

4

Performing a test print

1. Click **Print** to perform a test print.
2. Tap **No** if the test print was unsuccessful. Then, tap **Print Again**. If the second test print was unsuccessful, please contact us using the contact options.
3. Tap **Yes** if your test print was successful.
4. Tap **Get Started**. PitneyShip will now set up your experience. This could take a few minutes to complete.

Your PitneyShip Cube setup is now complete.

Installing PitneyShip Cube on a Mac using a USB connection (existing user)

These instructions will guide you through a first-time installation of your PitneyShip Cube on a Mac device as an existing PitneyShip user. These instructions are for users wanting to connect their PitneyShip Cube using a wired USB cable connection.

1. [Opening the box and unpacking](#)
2. [Logging in to your PitneyShip account](#)
3. [Connecting your PitneyShip Cube](#)
4. [Performing a test print](#)

1

Opening the box and unpacking

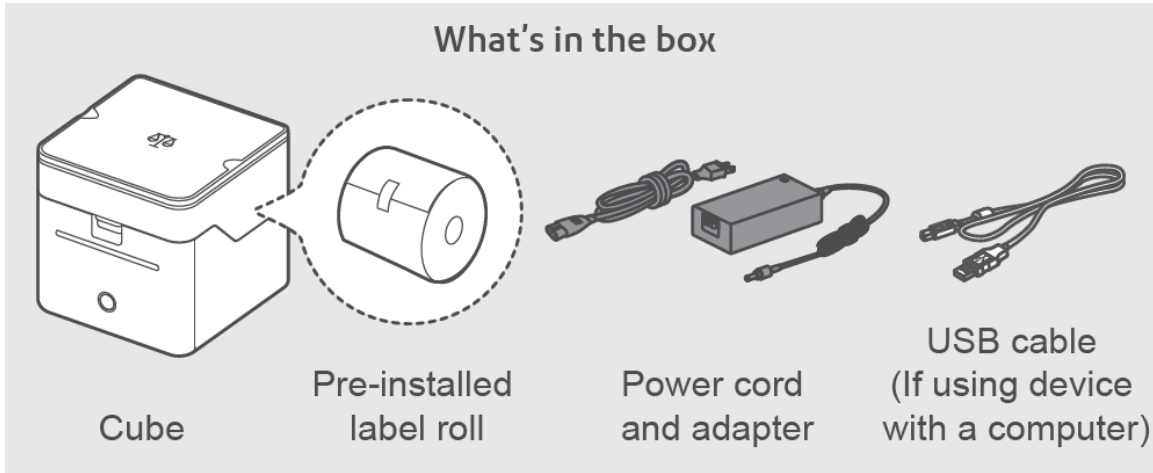

1. Unpack the device and remove the protective scale spacers.

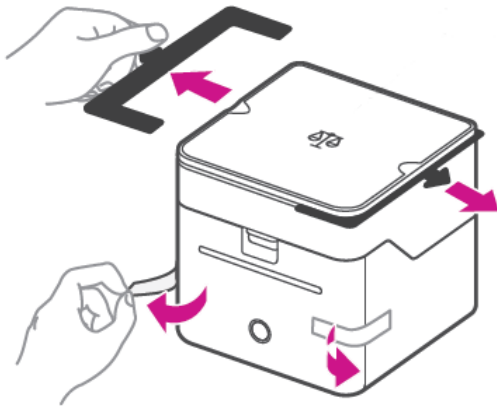

2. Feed the label roll into the slot.
 - a. Open the label roll cover.

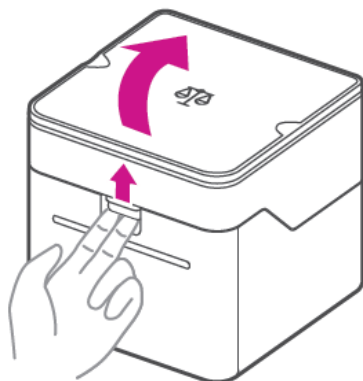

- b. Remove the protective sheet and the tape from the label roll.

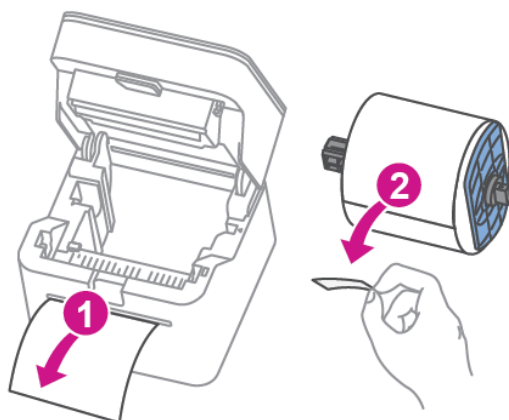

- c. Feed the label roll through the slot, and close the cover.

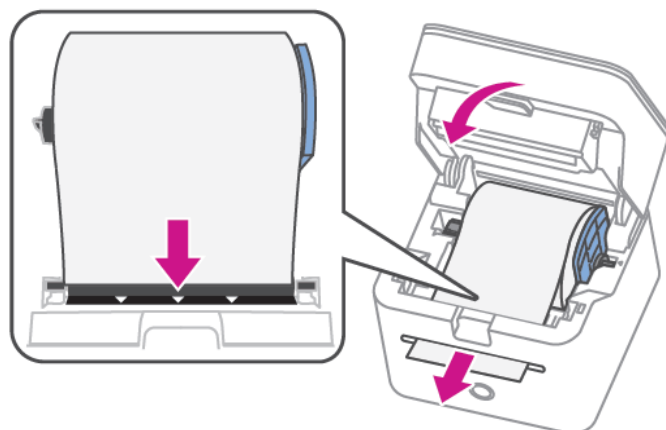

3. Connect the device to a power source and press the power button. The LED will light up orange and then change to flashing white until your PitneyShip Cube is connected.

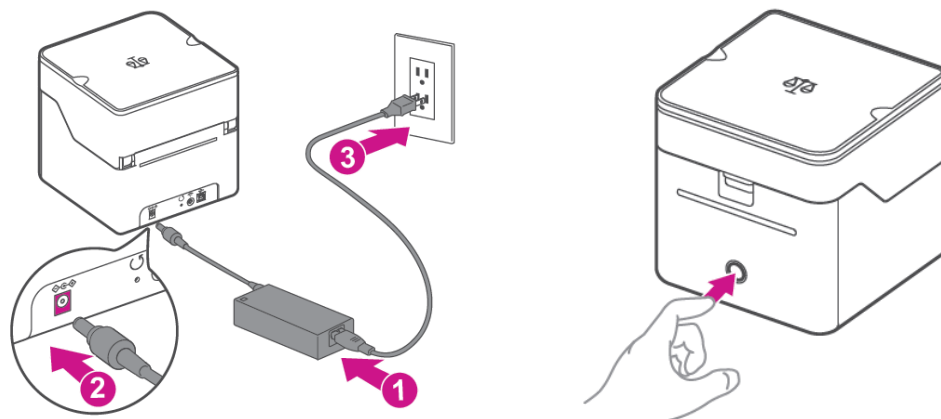

4. Set up and complete the installation using PitneyShip.

2

Logging in to your PitneyShip account

1. Go to cube.pitneybowes.com.
2. Click **Sign in**. You will be redirected to the login screen.
3. Enter your email address and password and click **Sign In**.
4. Click on **Get Started** to begin your PitneyShip Cube installation.

3

Connecting your PitneyShip Cube

1. When asked, "How do you want to connect your PitneyShip Cube?" select **With USB**.
2. Review the **Before installing** prompt and click **Next**.

Before installing:

Make sure you satisfy the following requirements:

1. You have admin access to install the drivers. If not, contact your system administrator.
2. PitneyShip Cube is turned ON and the light in front of the printer is solid white.



Next

3. Click **Download PitneyShip Cube Driver**.
 - a. Once the download is complete, go to the **PB_Printer_and_Scale_driver** installer.
 - b. Click **Continue**.
 - c. Click **Install**.
 - d. If prompted, enter your Mac password and click **Install Software**.
 - e. When the installation is complete, click **Close**.
 - f. Connect the USB cable to your printer and your computer.

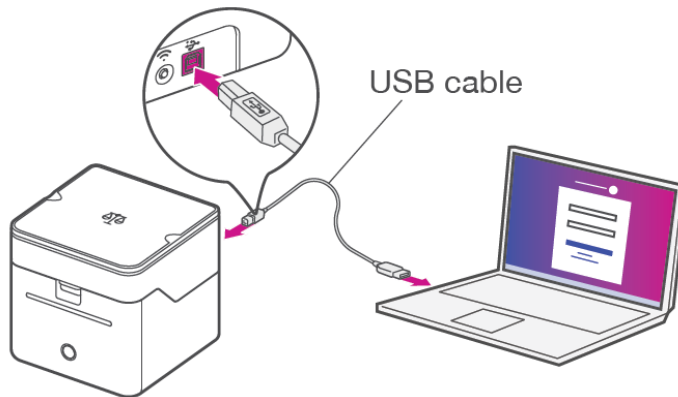

- g. On your computer, select **Finder > Applications > System Preferences > Printers and Scanners**.
- h. Click **Yes** to confirm that your PitneyShip Cube has been added to your printer list.
4. Click **Download DeviceHub**.
 - a. Once the download is complete, double-click the **DeviceHubXX.XX.X** file. This will open the installer.
 - b. Click **Install**.
 - c. If prompted, enter your Mac password and click **Install Software**.
 - d. Once the installation is complete, click **Close** to close the installer.
 - e. On your computer, check the Menu bar at the top of your desktop screen and find the DeviceHub icon. Click **Yes** to confirm that DeviceHub was successfully installed.
 - f. Click **Activate DeviceHub**. A new tab will open.
 - g. Once DeviceHub activation is successful, close the tab.
5. Click **Continue PitneyShip Cube Setup**.
6. Confirm your location and click **Next**.

4

Performing a test print

1. Click **Print** to perform a test print.
2. Tap **No** if the test print was unsuccessful. Then, tap **Print Again**. If the second test print was unsuccessful, please contact us using the contact options.
3. Tap **Yes** if your test print was successful.
4. Tap **Get Started**. PitneyShip will now set up your experience. This could take a few minutes to complete.

Your PitneyShip Cube setup is now complete.

Installing PitneyShip Cube on a Mac using a wireless connection (existing user)

These instructions will guide you through a first-time installation of your PitneyShip Cube on a Mac device as an existing PitneyShip user. These instructions are for users wanting to connect their PitneyShip Cube using a Wi-Fi connection. Before you begin your installation, you will need your mobile device to establish a Wi-Fi connection. .

1. [Opening the box and unpacking](#)
2. [Logging in to your PitneyShip account](#)
3. [Connecting your PitneyShip Cube](#)
4. [Performing a test print](#)

1 Opening the box and unpacking

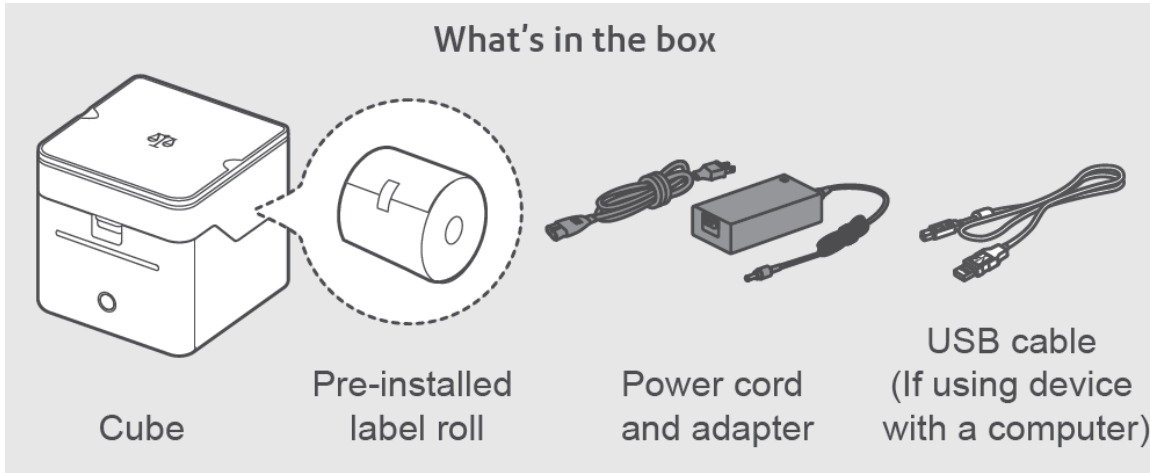

1. Unpack the device and remove the protective scale spacers.

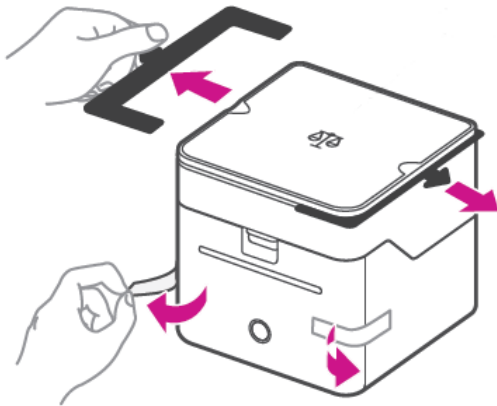

2. Feed the label roll into the slot.
 - a. Open the label roll cover.

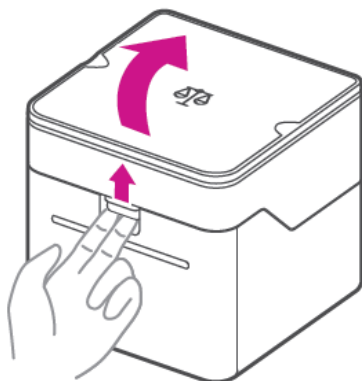

- b. Remove the protective sheet and the tape from the label roll.

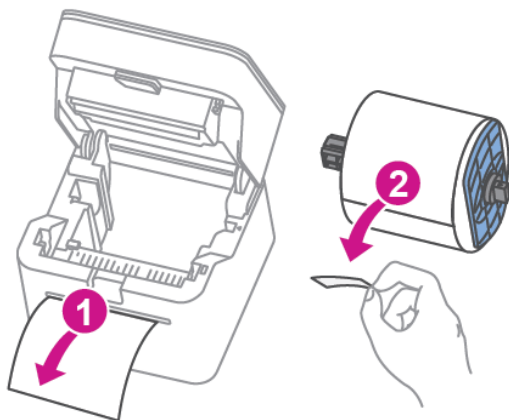

- c. Feed the label roll through the slot, and close the cover.

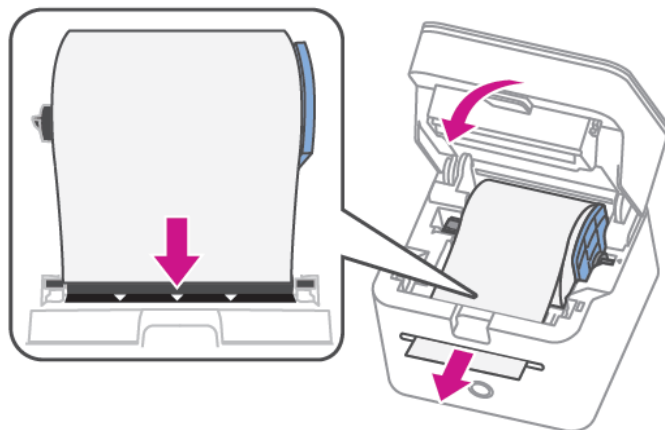

3. Connect the device to a power source and press the power button. The LED will light up orange and then change to flashing white until your PitneyShip Cube is connected.

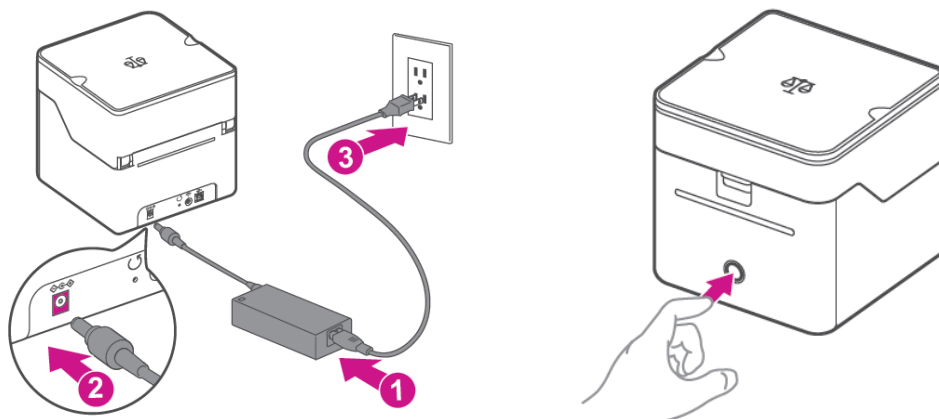

4. Set up and complete the installation using PitneyShip.

2

Logging in to your PitneyShip account

1. Go to cube.pitneybowes.com.
2. Click **Sign in**. You will be redirected to the login screen.
3. Enter your email address and password and click **Sign In**.
4. Click on **Get Started** to begin your PitneyShip Cube installation.

3

Connecting your PitneyShip Cube

1. When asked, "How do you want to connect your PitneyShip Cube?" select **With wi-fi**.
2. If you have previously connected your PitneyShip Cube to your phone, click **Yes**. If you have not connected your PitneyShip Cube to your phone, click **No**. You must connect your PitneyShip Cube to your phone before you can connect it wirelessly to your computer. To connect your PitneyShip Cube to your phone:
 - a. Download the PitneyShip mobile app. Scan the QR code below, or search for **PitneyShip - Ship and Track** in your phone's app store.



- b. Log in using your PitneyShip account email and password.
- c. On the home page, tap **Connect now**.



PitneyShip™

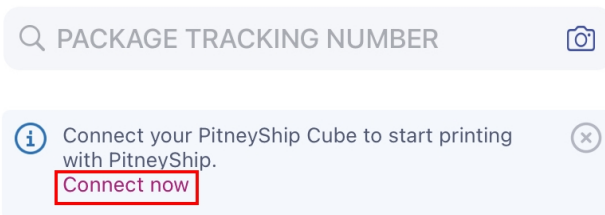

- d. Tap **Yes** if your PitneyShip Cube has a slow blinking light. If your PitneyShip Cube has a fast blinking light, or is showing a different LED color, tap **No**.
- e. Review the app permissions and tap **Next**.
- f. Tap **Join** to connect the PitneyShip mobile app to the PitneyShip Cube Wi-Fi network.
- g. Select your Wi-Fi network and enter your Wi-Fi password. If you do not see a list of Wi-Fi networks, tap **Refresh list** and select your Wi-Fi network.
- h. Your PitneyShip Cube is now connected to your network. Tap **Next**.
- i. Close the PitneyShip mobile app and return to your computer to continue the installation.
- j. Click **Next**.

3. Review the **Before installing** prompt and click **Next**.

Before installing:

Make sure you satisfy the following requirements:

1. You have admin access to install the drivers. If not, contact your system administrator.
2. PitneyShip Cube is turned ON and the light in front of the printer is solid white.

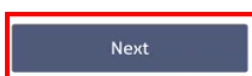

4. Click **Download PitneyShip Cube Driver**.
 - a. Once the download is complete, go to the **PB_Printer_and_Scale_driver** installer.
 - b. Click **Continue**.
 - c. Click **Install**.
 - d. If prompted, enter your Mac password and click **Install Software**.
 - e. When the installation is complete, click **Close**.
 - f. On your computer, select **Finder > Applications > System Preferences > Printers and Scanners**.
 - g. Click the **+** icon on the bottom left panel.
 - h. Select **Bixelon Printer and Scale**.
 - i. Click the **Use** drop down and select **Select Software**.

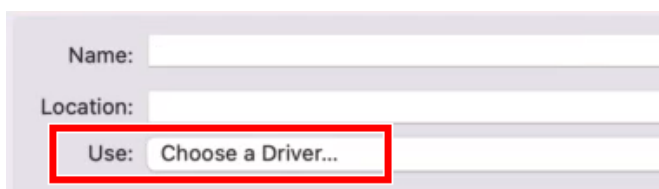

- j. Select **PitneyBowes Printer and Scale** and click **OK**.
- k. Click **Add**.
- l. Click **Yes** to confirm that your PitneyShip Cube has been added to your printer list.

5. Click Download **DeviceHub**.
 - a. Once the download is complete, double-click the **DeviceHubXX.XX.X** file. This will open the installer.
 - b. Click **Install**.
 - c. If prompted, enter your Mac password and click **Install Software**.
 - d. Once the installation is complete, click **Close** to close the installer.
 - e. On your computer, check the Menu bar at the top of your desktop screen and find the DeviceHub icon. Click **Yes** to confirm that DeviceHub was successfully installed.
 - f. Click **Activate DeviceHub**. A new tab will open.
 - g. Once DeviceHub activation is successful, close the tab.
6. Click **Continue PitneyShip Cube Setup**.
7. Confirm your location and click **Next**.

4

Performing a test print

1. Click **Print** to perform a test print.
2. Tap **No** if the test print was unsuccessful. Then, tap **Print Again**. If the second test print was unsuccessful, please contact us using the contact options.
3. Tap **Yes** if your test print was successful.
4. Tap **Get Started**. PitneyShip will now set up your experience. This could take a few minutes to complete.

Your PitneyShip Cube setup is now complete.

Installing PitneyShip Cube on a mobile device (new user)

These instructions will guide you through a first-time installation of your PitneyShip Cube printer on a mobile device as a new PitneyShip user.

1. [Opening the box and unpacking](#)
2. [Installing the PitneyShip mobile app](#)
3. [Creating your PitneyShip account](#)
4. [Connecting your PitneyShip Cube](#)
5. [Performing a test print](#)

1 Opening the box and unpacking

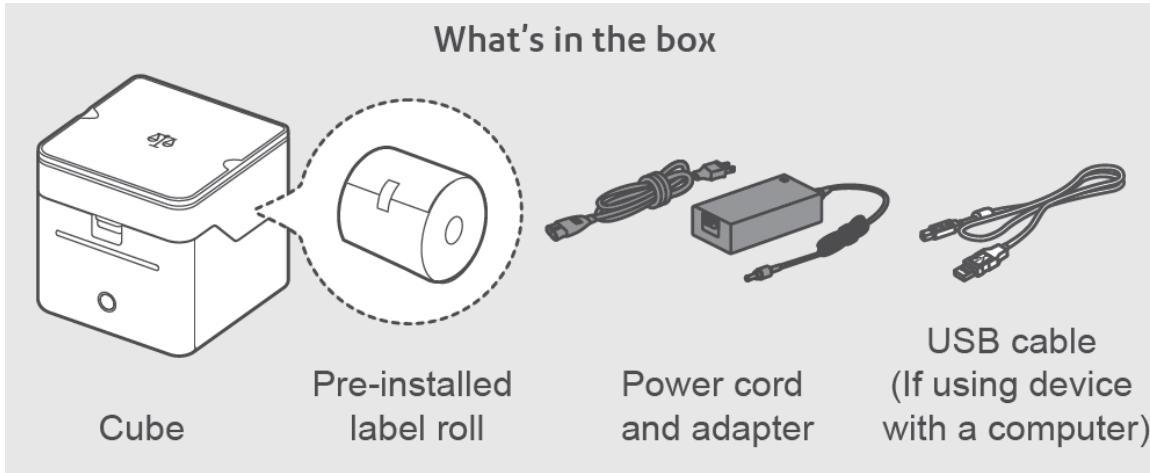

1. Unpack the device and remove the protective scale spacers.

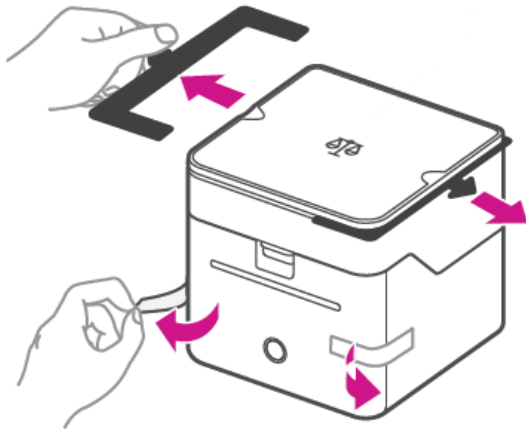

2. Connect the device to a power source and press the power button. The LED will light up orange and then change to flashing white until your PitneyShip Cube is connected.

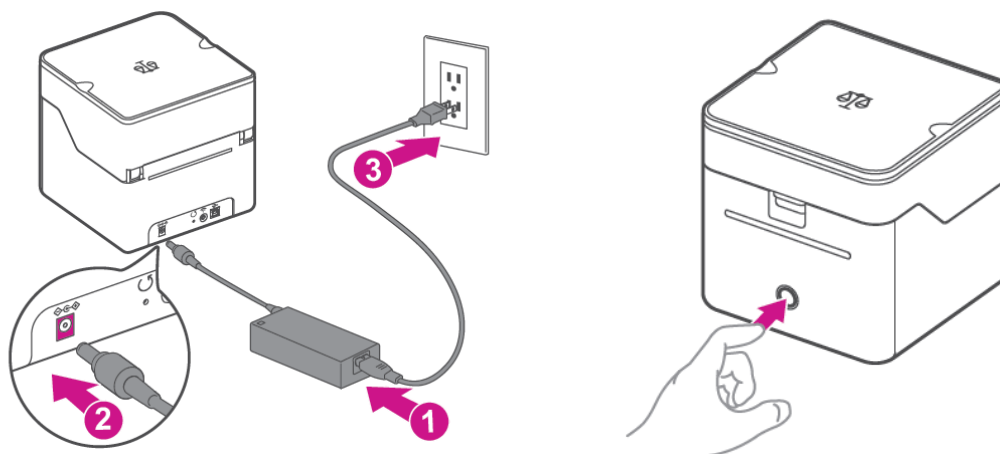

3. Set up and complete the installation using the PitneyShip mobile app.

2 Installing the PitneyShip mobile app

Scan the QR code with your phone's camera and install the PitneyShip mobile app.



3 Creating your PitneyShip account

1. Enter your email address, then tap **Next**.
2. Tap **Get Started**.
3. Select your PitneyShip plan.

4. Fill in your account details, then tap **Next**.
5. Fill in your Legal Business Name. If you do not have a legal business name, tap the **I am the sole proprietor without a legal business name** check box.

<

Create PitneyShip Account

LEGAL BUSINESS NAME

I am the sole proprietor without a legal business name. ⓘ

6. Fill in your business address fields.
7. Tap **Create Account**.
8. Your PitneyShip account creation is complete. Tap **Next** to set up your PitneyShip Cube.

4

Connecting your PitneyShip Cube

1. On the Set up a printer screen, tap **PitneyShip Cube**.

Set up a printer



PitneyShip Cube >



Another printer >

2. Tap **Next**.
3. Select your Wi-Fi network from the list of available networks, then tap **Next**. If you do not see a list of Wi-Fi networks, tap **Refresh list** and select your Wi-Fi network.

4. Allow PitneyShip to use your location.
5. Tap **Join** to allow PitneyShip to join the PitneyShip Cube Wi-Fi network.
6. Tap **OK** to allow PitneyShip to find and connect to devices on your local network.
7. Type in your Wi-Fi password, then tap **Connect**.

PitneyShip Cube will now connect to your Wi-Fi network. This could take a few minutes to complete. Once complete, you need to perform a test print.

5 Performing a test print

You will need to feed the label roll into the slot before printing a test label.

1. Open the label roll cover.

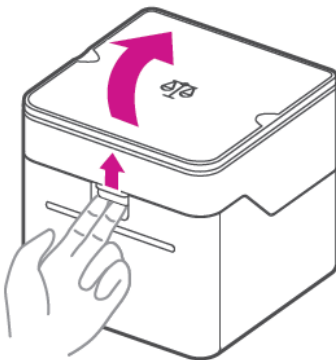

2. Remove the protective sheet and the tape from the label roll.

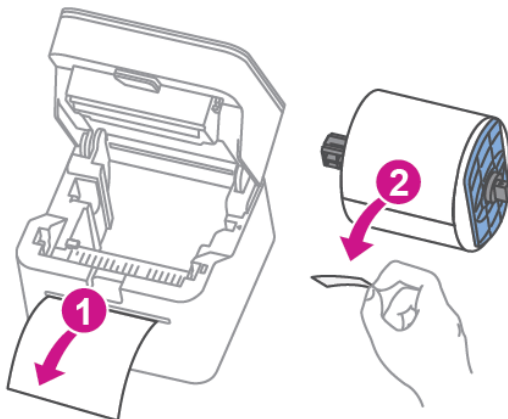

3. Feed the label roll through the slot, and close the cover.

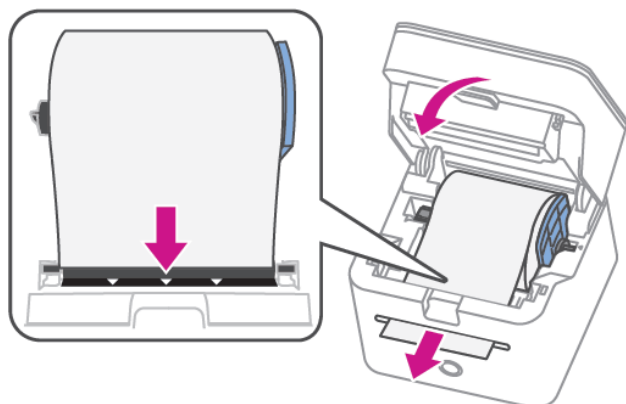

4. Tap **Next**.

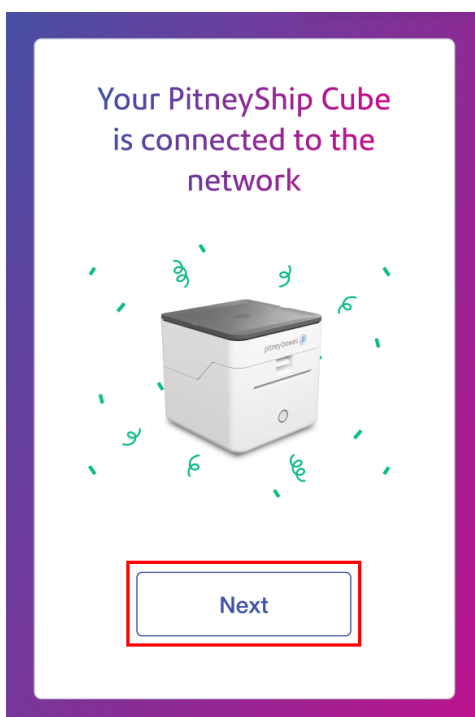

5. On the Print a Test Print page, tap **Print**.
6. If the test print was unsuccessful, tap **No**. Then, tap **Print Again**. If the second test print was unsuccessful, please contact us using the contact options.
7. If the test print was successful, tap **Yes**.
8. PitneyShip will now prepare your device and finalize setting up your account. Once complete, tap **Get Started**.

Your PitneyShip Cube setup is now complete.

Installing PitneyShip Cube on a mobile device (existing user)

These instructions will guide you through a first-time installation of your PitneyShip Cube printer on a mobile device as an existing PitneyShip user.

1. [Opening the box and unpacking](#)
2. [Installing the PitneyShip mobile app](#)
3. [Logging in to your PitneyShip account](#)
4. [Connecting your PitneyShip Cube](#)
5. [Performing a test print](#)

1 Opening the box and unpacking

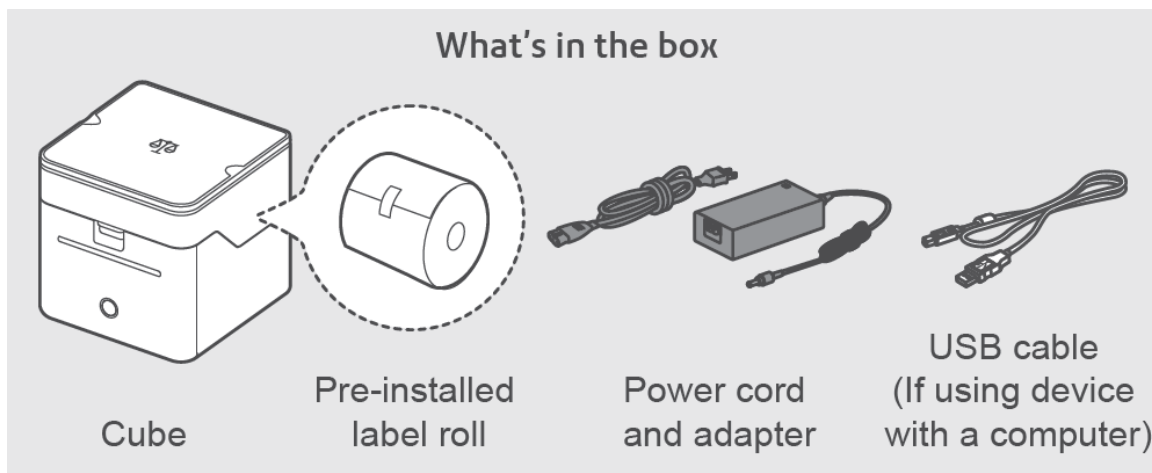

1. Unpack the device and remove the protective scale spacers.

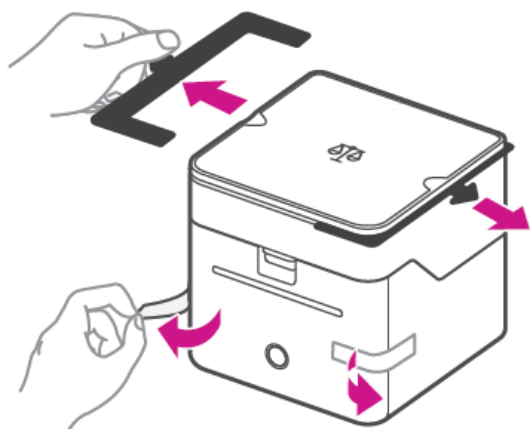

2. Connect the device to a power source and press the power button. The LED will light up orange and then change to flashing white until your PitneyShip Cube is connected.

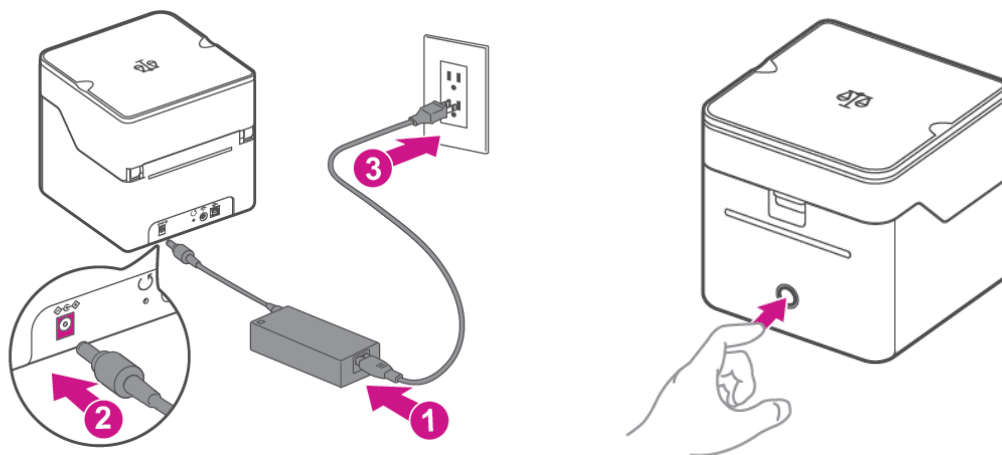

3. Set up and complete the installation using the PitneyShip mobile app app.

2

Installing the PitneyShip mobile app

Scan the QR code with your phone's camera and install the PitneyShip mobile app.



3

Logging in to your PitneyShip account

1. Enter your email address, then tap **Next**.
2. Enter your password, then tap **Sign In**.
3. Tap **More**.
4. Tap **Printer Options**.
5. Tap **Connect PitneyShip Cube**.

4

Connecting your PitneyShip Cube

1. On the Set up a printer screen, tap **PitneyShip Cube**.

Set up a printer



2. Tap **Next**.
3. Select your Wi-Fi network from the list of available networks, then tap **Next**.
4. Allow PitneyShip to use your location.
5. Tap **Join** to allow PitneyShip to join the PitneyShip Cube Wi-Fi network. If you do not see a list of Wi-Fi networks, tap **Refresh list** and select your Wi-Fi network.
6. Tap **OK** to allow PitneyShip to find and connect to devices on your local network.
7. Type in your Wi-Fi password, then tap **Connect**.

PitneyShip Cube will now connect to your Wi-Fi network. This could take a few minutes to complete. Once complete, you will be asked to perform a test print.

5

Performing a test print

You will need to feed the label roll into the slot before printing a test label.

1. Open the label roll cover.

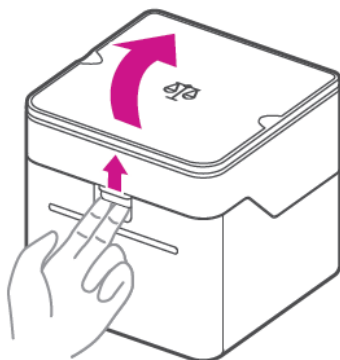

2. Remove the protective sheet and the tape from the label roll.

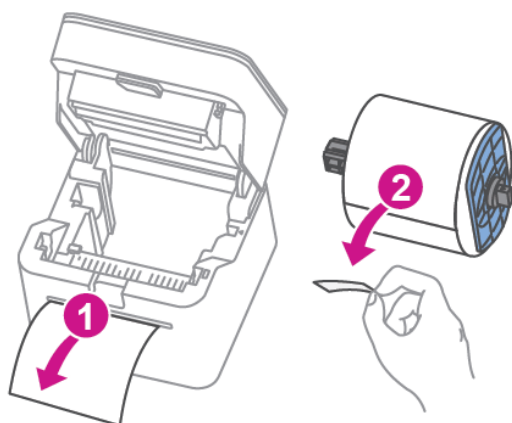

3. Feed the label roll through the slot, and close the cover.

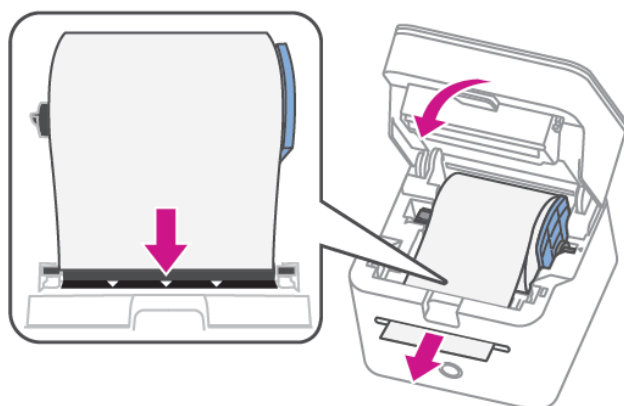

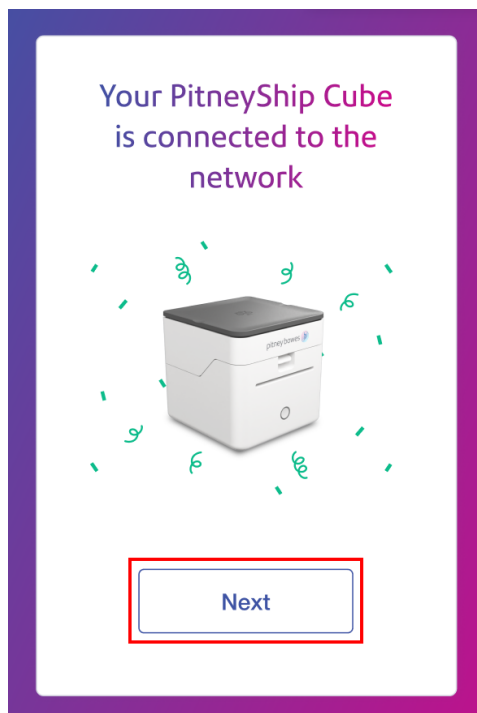
4. Tap **Next**.

5. On the Print a Test Print page, tap **Print**.
6. If the test print was unsuccessful, tap **No**. Then, tap **Print Again**. If the second test print was unsuccessful, please contact us using the contact options.
7. If the test print was successful, tap **Yes**.
8. PitneyShip will now prepare your device and finalize setting up your account. Once complete, tap **Get Started**.

Your PitneyShip Cube setup is now complete.

2 - Connectivity

In this section

Reconnecting your PitneyShip Cube to the PitneyShip mobile app 71

Reconnecting your PitneyShip Cube to the PitneyShip mobile app

If you have moved your PitneyShip Cube to a new location, you will need to connect to a new Wi-Fi network. Follow the steps below to connect your PitneyShip Cube.

1. Long press the Wi-Fi button located on the back of the PitneyShip Cube to enter pairing mode. When the LED slowly flashes white, it is in pairing mode.
2. From the PitneyShip mobile app, tap **More > Printer Options**.
3. Tap **Connect**.

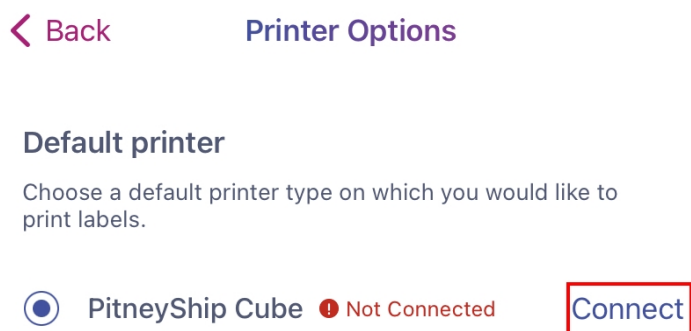

4. Tap **Try Again** on the "Unable to connect to PitneyShip Cube" error message.

5. Tap **Join** on the "PitneyShip™" Wants to Join Wi-Fi Network "PitneyShip Cube"? pop-up message.

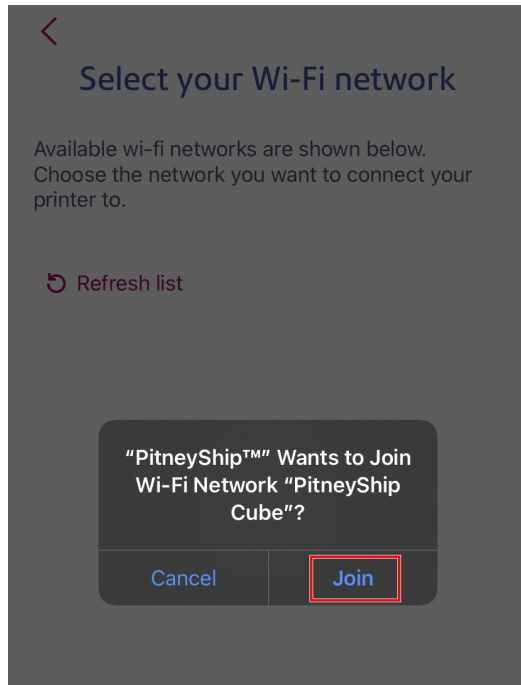

6. Select your Wi-Fi network from the list of available networks.
7. Enter your Wi-Fi network password.
8. Tap **Connect**.

Your PitneyShip Cube is now connected to a Wi-Fi network. You can print a test label to verify the connection. See [Printing a test label using the PitneyShip Cube with the PitneyShip mobile app](#).

3 - Downloads and Drivers

In this section

Installing the PitneyShip Cube driver on an additional computer 74

Installing the PitneyShip Cube driver on an additional computer

After initially installing your PitneyShip Cube, you may need to install the driver on another computer.

Select your operating system:

- [Windows](#)
- [Mac](#)

Windows

1. Log in to PitneyShip or PitneyShip Pro on the additional computer.
2. Select **Support & Cases** and download the PitneyShip Cube driver.

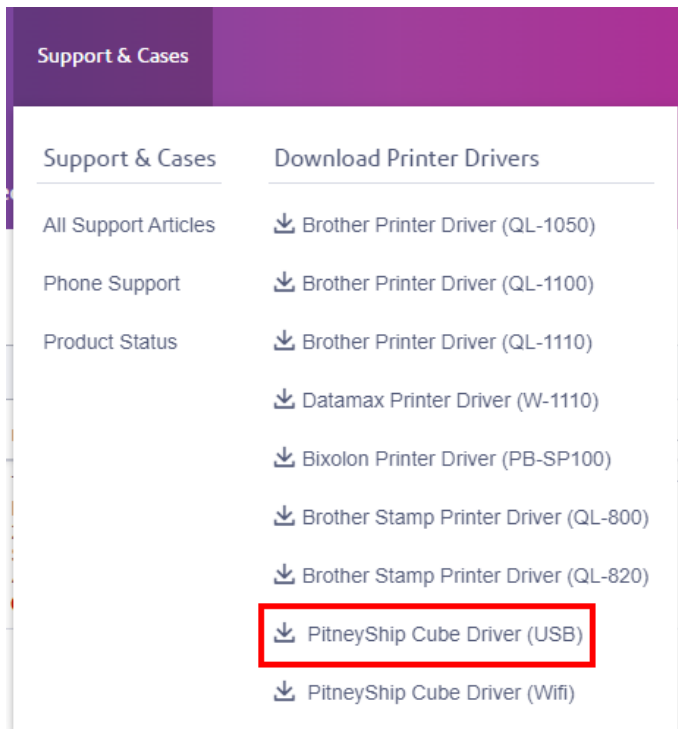

3. Once the download is complete, go to your downloads folder and double-click the **PB_Printer_and_Scale_driver.exe** file.
4. When the installer window opens, accept the license agreement and click **Next**.
5. On the installation Directory, click **Next**.
6. Click **Finish**. After a few moments, the Seagull Driver Wizard will open.
7. To install printer drivers, click **Next**.

8. When asked, "How is this printer going to be attached?" you must select USB. Follow the instructions to connect the PitneyShip Cube USB cord to the computer. Then power on the PitneyShip Cube.
9. Once the PitneyShip Cube is powered on, click **Next** to install the Plug and Play printer.
10. Click **Next**.
11. Then click **Finish**. The files will then install.
12. Click **Close** when the Wizard is complete.
13. Ensure that you have installed DeviceHub on the new computer. See [Installing DeviceHub for PitneyShip and PitneyShip Cube](#).

Mac

1. Log in to PitneyShip or PitneyShip Pro on the additional computer.
2. Select **Support & Cases** and download the PitneyShip Cube driver.

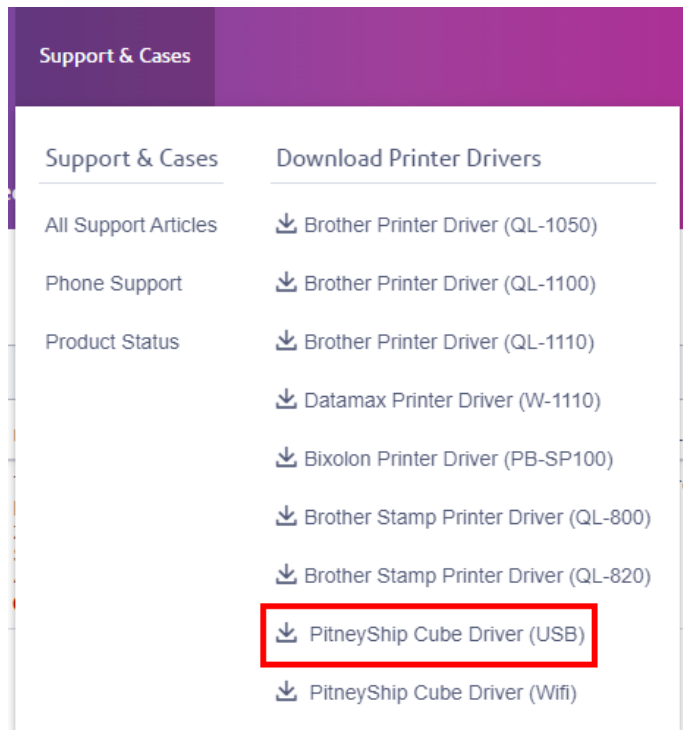

3. When the install window opens, click **Continue**.
4. Click **Install**.
5. If prompted, enter your Mac password and select **Install Software**. The software will then download. This download could take a few minutes.
6. Once successfully installed, select **Close**.
7. Connect the PitneyShip Cube USB cable to your Mac computer.
8. Connect the PitneyShip Cube power cord.

9. Turn on the PitneyShip Cube and wait a few seconds.
10. Ensure that you have installed DeviceHub on the new computer. See [Installing DeviceHub for PitneyShip and PitneyShip Cube](#).

4 - Feeding and Jamming

In this section

Clearing a label jam on the PitneyShip Cube 78

Clearing a label jam on the PitneyShip Cube

If the label jams, the LED on your PitneyShip Cube will flash red, and you need to clear the label jam before printing a label or stamp.

1. Open the label roll cover.

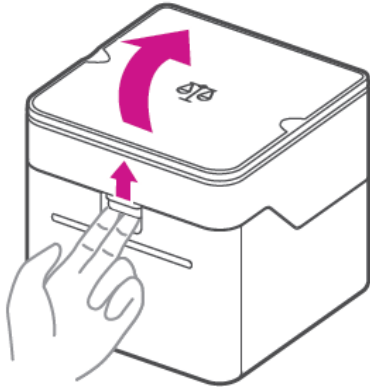

2. Feed the label roll through the slot to clear the jam.
3. Close the label roll cover. The cutter will then cut the label.

5 - Maintenance

In this section

Changing the label roll on the PitneyShip Cube 80

Changing the label roll on the PitneyShip Cube

You can use generic label rolls to print shipping labels on the PitneyShip Cube, however, to print stamps, you will need to use the Pitney Bowes specific label roll as it contains the fluorescent strip required by the USPS.

[Order Supplies](#)

1. Open the label roll cover.

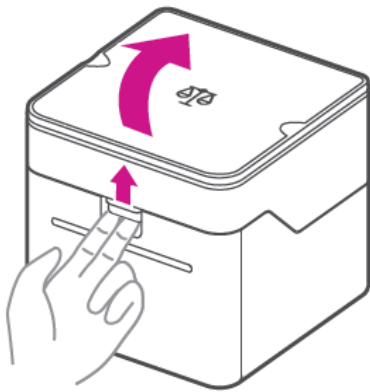

2. Remove the empty label roll.
3. Remove the protective tape from the new label roll.
4. Insert the new label roll into the printer.
5. Feed the label roll through the slot, and close the cover.

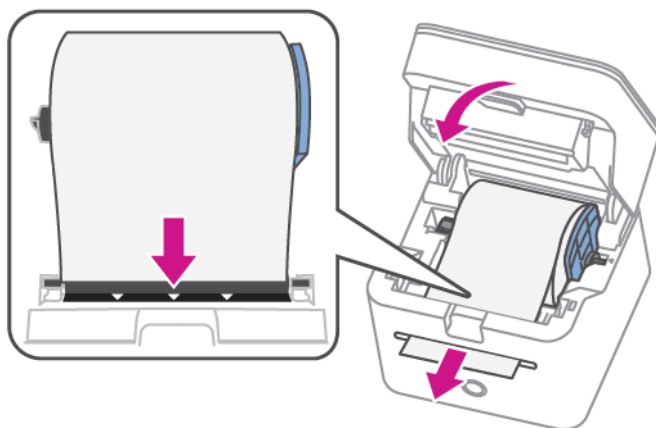

6 - Printing

In this section

Printing a test label using the PitneyShip Cube with the PitneyShip mobile app 82

Printing a test label using the PitneyShip Cube with the PitneyShip mobile app

You can print a no value, test print of your shipping label before spending your loaded postage. Follow the steps below to print a test label.

From the PitneyShip mobile app Home screen:

1. Tap **More > Printer Options**.
2. Select the label size you wish to print.
3. Tap **Print Sample**.

7 - Product Information

In this section

Understanding your printer LED light codes for the PitneyShip Cube

84

Understanding your printer LED light codes for the PitneyShip Cube

The LED light on the front of the PitneyShip Cube indicates the status of the printer in operation.

- *White (solid)*
- *White Flashing (fast)*
- *White Flashing (slow)*
- *Orange On*
- *Orange Flashing (slow)*
- *Red On*
- *Red Flashing (slow)*

White (solid)

What this means

The device is ready.

Action

No action needed.

White Flashing (fast)

What this means

The PitneyShip Cube is in a transition state and is processing commands.

Action

No action needed.

White Flashing (slow)

What this means

The PitneyShip Cube is in pairing mode and is ready to be connected to a Wi-Fi network.

Action

Select your Wi-Fi network from the list of available networks.

Orange On

What this means

Error- There is no label roll installed, or the printer cover is open.

Action

Close the printer cover, or install the label roll. See [Steady orange power light on the PitneyShip Cube](#)

Orange Flashing (slow)

What this means

Error- The PitneyShip Cube is connected to a Wi-Fi network that is currently unavailable.

Action

Reconnect to Wi-Fi. See [Reconnecting your PitneyShip Cube to the PitneyShip mobile app](#).

Red On

What this means

Hardware error

Action

Contact client support.

Red Flashing (slow)

What this means

Error- Paper jam

Action

Clear paper jam. See [Clearing label jams on the PitneyShip Cube](#).

8 - Scales and Weighing

In this section

Using the PitneyShip Cube scale with the PitneyShip mobile app	87
Zeroing the scale on the PitneyShip Cube	87

Using the PitneyShip Cube scale with the PitneyShip mobile app

To weigh your package, you first have to create a shipping label. See [Creating a shipping label in the PitneyShip mobile app](#). From the Package Type screen:

1. Select your package type.
2. Place your package on the scale.
3. Tap the scale icon next to the package or envelope weight field.



Your package weight will now be filled in.

Zeroing the scale on the PitneyShip Cube

You can reset the scale to zero to prevent incorrect package weight. Before zeroing the scale, remove any packages or envelopes from the scale.

From the PitneyShip mobile app:

1. Tap **More**.
2. Tap **About Device**.
3. Tap **Zero Scale**.

The scale will now zero out the weight.

From PitneyShip:

1. Click the gear icon to access settings.
2. Click on **My Devices**.
3. Click on the zero scale arrow.

The scale will now zero out the weight.

9 - PitneyShip mobile app

In this section

Installing the PitneyShip mobile app App	89
Refilling postage in the PitneyShip mobile app	89
Creating a Shipping Label in the PitneyShip mobile app	90
Importing an address using your mobile device camera in PitneyShip Mobile	92
Adding an Address to the Address Book in the PitneyShip mobile app	92
Editing an Address in the PitneyShip mobile app	93
Deleting an Address from the Address Book in the PitneyShip mobile app	93
Tracking a Shipment in the PitneyShip mobile app	94
Connecting your Amazon store to the PitneyShip mobile app	94
Connecting your eBay store to the PitneyShip mobile app	95
Connecting your Shopify store to the PitneyShip mobile app	96
Changing your PitneyShip subscription using the PitneyShip mobile app	97

Installing the PitneyShip mobile app App

In order to use the PitneyShip mobile app, you first need to install the app on your phone. The app is available in the Apple App Store and Google Play Store.

Method 1

1. Scan this QR code to go directly to the app in your phone's app store.



2. Download and install it as you would any other app.

Method 2

1. On your phone, open the **App Store** (Apple) or **Play Store** (Google Android).
2. Search for **PitneyShip Ship and Track**.
3. Tap on the PitneyShip mobile app App.
4. Download and install it as you would any other app.

Refilling postage in the PitneyShip mobile app

You can add postage to your USPS account through the PitneyShip mobile app.

1. On the Home screen, tap **More > Funding**.
2. To add one of the preset amounts, tap on it.
3. To add a different amount, tap **Custom** and enter the amount on the line.
4. (Optional) To assign this postage purchase to a cost account, tap the **Cost Account** menu and select the account.
5. Tap **Add Postage**.

Creating a Shipping Label in the PitneyShip mobile app

You can use the PitneyShip mobile app to create a shipping label and print it directly from your phone.

The PitneyShip mobile app can only create domestic shipping labels. To create international or APO labels, use PitneyShip in your web browser.

- *Quick steps*: Follow these steps when printing a simple shipping label.
- *Step-by-step*: Follow these steps to review all the available shipping label options.
- *Reprinting the label, requesting a refund, or shipping another label*

Quick Steps

1. Tap **Ship** on the Home screen.
2. Tap the **Package Type** tab and choose your packaging type.
3. Enter the recipient address.
4. Tap **Continue**.
5. Verify the address if asked.
6. Select the service.
7. Tap **Print**.

Step-by-step

1. On the Home screen, tap **Ship**.
2. (Optional) To use a preset that you have previously created in PitneyShip, tap the **Choose Preset** tab and tap the desired preset. Presets must be created and edited in the desktop version of PitneyShip.
Tip: If new presets were added, you can swipe down in the app to refresh the presets list.
3. If not using a preset, tap the **Package Type** tab and choose your packaging type.
4. If using carrier-specific packaging, tap the carrier, then select the package type. Scroll down to see more package types.
5. If using your own packaging, tap **My Packaging**, then select the package type. To enter the dimensions and weight, tap on each field and enter the measurement.
6. Tap **Continue**.
7. (Optional) To change the sender address, tap the **Sender Address** at the top and select the desired address.

8. (Optional) To assign this label to a cost account, tap the **Cost Account** menu and select the desired account.
9. Enter the recipient address, or tap the address book icon and select it from the address book. If you enter a new address, tap the **Save to address book** box to save it in your address book.
10. To email the tracking number when you print the label, tap the **Email the tracking number** box. The sender and recipient email addresses are automatically filled in if they are in the address book. If the address is not automatically filled in, tap on the line below the box and enter it. To add another address, tap next to the first address.
11. Tap **Continue**.
12. If prompted to verify the address, tap **Use Suggested**.
13. Select the service you wish to use. Scroll down to see all available services.
14. Optional:
 - To add extra services, tap **Add Extra Services**, select the services, and tap **Apply**.
 - By default, rates from all carrier accounts are shown. To remove accounts, tap **Filter**, tap the accounts you do not wish to use, and tap **Done**.
 - By default, the services are sorted by delivery speed (Fastest). To sort by price, tap **Fastest > Lowest Rate**.
 - To go back to the previous step, tap the back arrow at the top.
 - To start over from step 2, tap **Start Over**.
15. To print the label directly from your phone if you have a printer installed:
 - a. Tap **Print**.
 - b. If the Label Options screen opens, select the label options, then tap **Print**.
 - c. (Optional) Tap **Print Sample** to print a sample label.
 - d. When the label opens, select the printer, select any other needed options, then tap **Print** to print the label.

Note: If USPS SCAN Form printing is enabled in the PitneyShip mobile app, the label will be added to the current SCAN Form.

Reprinting the label, requesting a refund, or shipping another label

After creating a label, tap the 3 dots menu in the upper right  if you need to reprint the label, request a refund, or ship another of the same label.

Note: The last 10 labels you printed from the PitneyShip mobile app to a Wi-Fi printer are available in your phone's Downloads folder. Labels printed to a Bluetooth printer are not on this list.

Importing an address using your mobile device camera in PitneyShip Mobile

You can use your mobile device camera to scan an address and import it into your address book in PitneyShip Mobile.

From the PitneyShip mobile app Home screen:

1. Tap **More > Address Book**.
2. Tap the **Add New Contact** icon.



3. Tap the camera icon.
4. If prompted, tap **OK** to allow PitneyShip to access your device camera.
5. Align the text within the grid and tap the capture button.
6. Tap the **Preview** button to preview the address.

Adding an Address to the Address Book in the PitneyShip mobile app

Addresses added in the PitneyShip mobile app are also visible on other PitneyShip products.

To add an address manually:

1. On the home screen, tap **More > Address Book**.
2. (Optional) If you wish to add a sender instead of a recipient, tap the **Senders** tab.
3. Tap the add icon.



4. Enter the contact details.
5. Tap **Save**.

To add an address using the camera:

1. On the home screen, tap **More > Address Book**.
2. (Optional) If you wish to add a sender instead of a recipient, tap the **Senders** tab.

3. Tap the add icon.



4. Tap **Scan Address**.
5. If prompted for access to your phone's camera, allow it.
6. Point the phone's camera at the address you wish to scan. Align the address inside of the box and tap the camera (white circle) button.
7. Drag the corners of the box so that only the address is showing inside the box. Anything that is not part of the address should be cropped out.
8. Tap the capture button.
9. Add any additional information you wish to add.
10. Tap **Save**.

Editing an Address in the PitneyShip mobile app

Addresses edited in PitneyShip mobile app are also updated in the address books of other PitneyShip products.

1. On the home screen, tap **More > Address Book**.
2. If the address you wish to edit is a sender, tap the **Senders** tab.
3. Tap the address you wish to edit.
4. Tap the edit icon.
5. Edit the contact details as needed.
6. Tap **Update**.

Deleting an Address from the Address Book in the PitneyShip mobile app

You can delete addresses that you no longer need from your address book. Addresses that are deleted from the PitneyShip mobile app address book are also removed from the address book in other PitneyShip products.

1. On the home screen, tap **More > Address Book**.
2. If the address you wish to delete is a sender, tap the **Senders** tab.
3. Tap the address you wish to delete.
4. Tap the delete icon.
5. Tap **Delete**.

Tracking a Shipment in the PitneyShip mobile app

You can use PitneyShip mobile app to track shipments that you have created in PitneyShip, as well as any package for which you have a tracking number.

To track a shipment that was sent through PitneyShip:

1. If the shipment you wish to track is listed under **History** on the Home screen, tap on it there.
Tip: Swipe down on the **History** tab to refresh the list.
2. If the shipment you wish to track is not listed under **History**, tap **More > History**, then tap on the package you wish to track.

To track a package for which you have a tracking number:

1. On the Home screen, enter the tracking number in the **Package Tracking Number** field.
2. To speak the tracking number instead of typing it, tap the microphone icon in the **Package Tracking Number** field and say the tracking number.
3. Tap the search button on the phone's keyboard.
4. If you have a barcode, tap the camera icon in the **Package Tracking Number** field and point the phone's camera at the barcode. The tracking details automatically appear.

Connecting your Amazon store to the PitneyShip mobile app

Connecting your Amazon store to the PitneyShip mobile app allows you to manage data between both platforms.

To add your Amazon store to the PitneyShip mobile app:

1. From the Home screen, tap **Orders**.
2. Tap the ellipses on the Manage Orders page.

Select

Filter



Manage Orders

Q Search

3. Tap **Add Store**.

4. Tap the **Amazon** icon from the list of stores.
5. Log in to your Amazon seller account and tap **Sign-In**.
6. Tap the check box to allow the PitneyShip mobile app access to your Amazon Selling Partner account. This step is necessary to sync your Amazon orders to the PitneyShip mobile app.

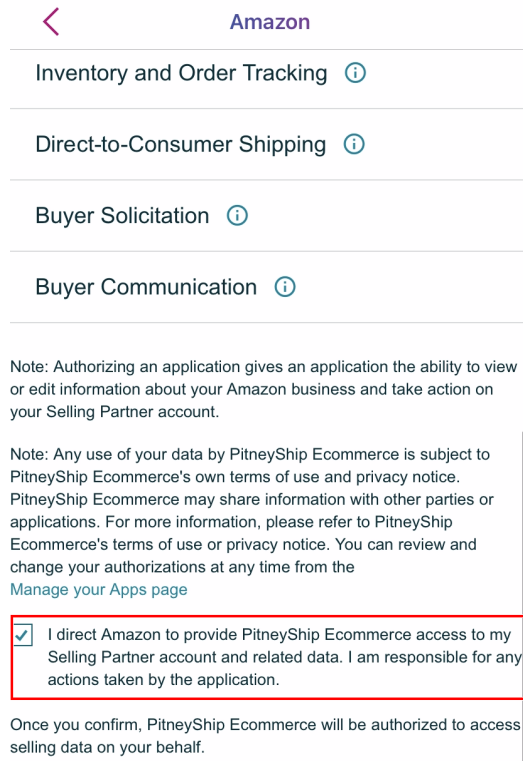

7. Tap **Confirm**.
8. The PitneyShip mobile app will connect to your store. Once the connection is complete, tap **Next**.
9. (Optional) Select your default carrier settings and tap **Done**. Tap **Skip This Step** to exit and complete your store's connection.
10. You will now be on the Manage Orders page. Swipe down to sync your orders.

Connecting your eBay store to the PitneyShip mobile app

Connecting your eBay store to the PitneyShip mobile app allows you to manage data between both platforms.

1. From the Home screen, tap **Orders**.
2. Tap the ellipses on the Manage Orders page.

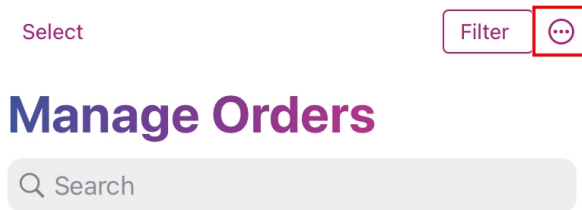

3. Tap **Add Store**.
4. Tap the **eBay** icon from the list of stores.
5. Enter your email or username and tap **Continue**.
6. Enter your password and tap **Sign-In**.
7. The PitneyShip mobile app will connect to your store. Once the connection is complete, tap **Next**.
8. (Optional) Select your default carrier settings and tap **Done**. Tap **Skip This Step** to exit and complete your store's connection.
9. You will now be on the Manage Orders page. Swipe down to sync your orders.

Connecting your Shopify store to the PitneyShip mobile app

Connecting your Shopify store to PitneyShip mobile app allows you to manage data between both platforms.

1. From the Home screen, tap **Orders**.
2. Tap the ellipses on the Manage Orders page.

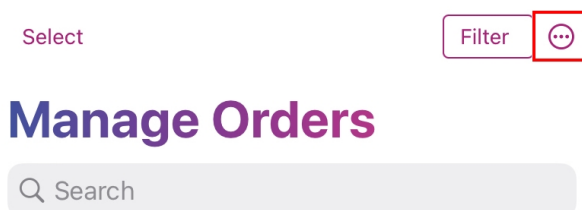

3. Tap **Add Store**.
4. Tap the Shopify icon from the list of stores.

5. Enter your store name and tap **Next**.
6. **(Optional)** Select your default carrier settings and tap **Done**. Tap **Skip** to exit and complete your store's connection.
7. You will now be on the Manage Orders page. Swipe down to sync your orders.

Changing your PitneyShip subscription using the PitneyShip mobile app

PitneyShip offers different subscriptions that include certain features. You can upgrade your plan to access different features.

1. Launch the PitneyShip mobile app and select **More**.
2. Scroll until **Plans and Subscriptions** appears.
3. Select **Plans and Subscriptions**.
4. Select **Plan Options**.
5. If prompted to log in, enter your PitneyShip username and password, and select **Log In**.
6. Scroll until the desired plan is located and select **Choose Plan**.
7. Enter the required information and select **Continue**.
8. Verify the information entered is correct and click **Continue**.
9. Click **Place Order** to finalize the plan change.

10 - Safety

In this section

Important Safety and Compliance Information for Your
Printer and Scale 99

Important Safety and Compliance Information for Your Printer and Scale

Product: Direct Thermal Label Printer	
Model: AX00	Power Requirements: 100-240 VAC, 50/60 Hz, 1.5 A
Sound level: < 70 dba	Operating Temperature: 32-104°F (0-40°C)
Agency Compliance:	pitneybowes.com

Important Safety Notes

Follow the normal safety precautions for all office equipment.

- Please read all instructions before you attempt to operate the system. Save these instructions for future use.
- Use only Pitney Bowes approved supplies, in particular, aerosol dusters. Improper storage and use of aerosol dusters or flammable aerosol dusters can cause an explosive-like condition that could result in personal injury and/or property damage. Never use aerosol dusters labeled flammable and always read instructions and safety precautions on the duster label.
- This printer is powered by an external AC power adapter. Use only the AC power adapter and AC power cord supplied with the printer and plug it into a properly grounded wall outlet that's located near the printer and easily accessible. Failure to properly ground the power adapter can result in severe personal injury and/or fire.
- The power cord wall plug is the primary means of disconnecting the power adapter from the AC supply. The power adapter is on whenever it is plugged into a live receptacle.
- Place the printer so the AC power adapter is close to an easily accessible wall outlet. DO NOT use a wall outlet controlled by a wall switch or one that is shared with other equipment.
- DO NOT use an adapter plug on the power cord or wall outlet.
- DO NOT remove the ground pin from the power cord.
- Make sure the area in front of the wall outlet into which the AC adapter is plugged is free from obstruction.
- DO NOT route the power cord over sharp edges or trap it between pieces of furniture. Make sure there is no strain on the power cord.
- DO NOT route the DC power cable that plugs into the printer over sharp edges or trap it between pieces of furniture. Make sure there is no strain on the DC power cable.

- To reduce the risk of fire or electrical shock, DO NOT attempt to remove covers or disassemble the control panel or its base. The cabinet encloses hazardous parts. If you should drop or otherwise damage the unit, call Pitney Bowes.
- Use only Pitney Bowes approved direct thermal label media.
- Keep fingers, long hair, jewelry and loose clothing away from moving parts at all times.
- Avoid touching moving parts or materials while the printer is in use. Before clearing a stall (jam), be sure printer mechanisms come to a complete stop.
- To prevent overheating, do not cover the vent openings.
- When removing stalled material, avoid using too much force to protect against minor personal injury and damage to the equipment.
- Use the equipment only for its intended purpose.
- Always follow the specific occupational safety and health standards prescribed for your workplace.
- DO NOT insert anything into the tape slot from the outside of the printer, there is a cutter operating in the slot that cuts the tape.



Caution: Changes or modifications to this equipment not expressly approved by the part responsible for compliance could void the user's authority to operate the equipment.

If using USB interface, shielded I/O cables must be used with this equipment to ensure compliance with the limits. Use of unshielded cables is prohibited.



International ENERGY STAR® Qualification Statement

The purpose of the International ENERGY STAR® Program is to promote the development and popularization of energy-efficient office equipment. As an ENERGY STAR® Partner, BIXOLON Co., Ltd. has determined that this product meets the ENERGY STAR® specifications for energy efficiency.



3001 Summer Street
Stamford, Connecticut 06926
www.pitneybowes.com

SV63411 Rev. A
©2023 Pitney Bowes Inc.
All Rights Reserved