

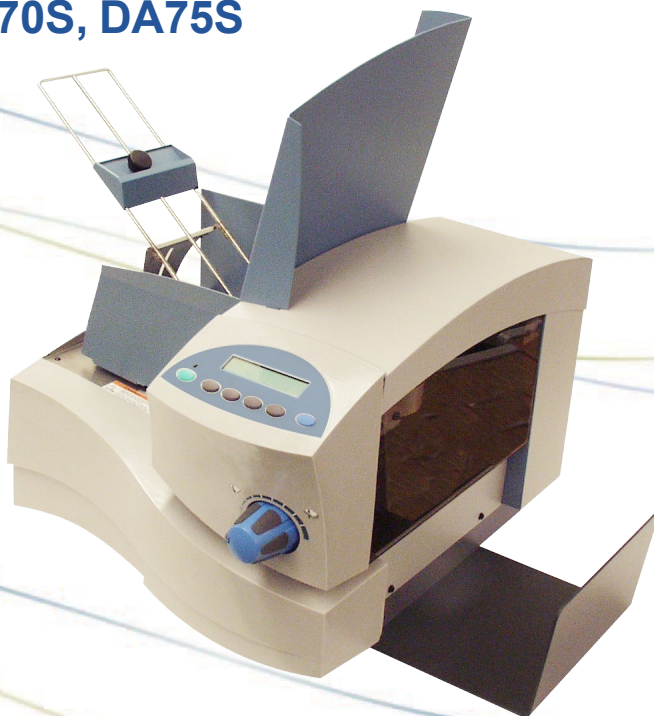

AddressRight™ DA Series Printer DA70S, DA75S



Operator Guide

US/International English Version

NOTICE

The use of this information by the recipient or others for purposes other than the repair, adjustment or operation of Pitney Bowes equipment may constitute an infringement of patent and/or other intellectual property rights of Pitney Bowes or others. Pitney Bowes assumes no responsibility for any such use of the information.

Except as provided in writing, duly signed by an officer of Pitney Bowes, no license, either express or implied, under any Pitney Bowes or any third party's patent, copyright, or other intellectual property rights is granted by providing this information.

SV61665 Rev. E

Fifth Edition, February, 2024.

©2024 Pitney Bowes Inc. All rights reserved.

This book may not be reproduced in whole or in part in any fashion or stored in a retrieval system of any type or transmitted by any means, electronically or mechanically, without the express written permission of Pitney Bowes.

We have made every reasonable effort to assure the accuracy and usefulness of this manual, however we cannot assume responsibility for errors or omissions or liability for the misuse or misapplication of our products.

Envelope Designer and SmartMailer are registered trademarks of Pitney Bowes, Inc. Microsoft and Windows are trademarks or registered trademarks of Microsoft Corporation.

NOTE: DA70S/DA75S

The similarity of the DA70S and DA75S printers allows their features and operation to be documented together. The principle difference in these printers is that the DA75S is a color printer that uses both a black and color ink cartridge. The DA70S only uses a black ink cartridge.

The photos and illustrations in this document are of the DA75S printer, but representative of each printer.

IMPORTANT: Model and feature availability varies by country. Contact your machine supplier for more information. This guide covers all models and features. Inclusion within this guide does not guarantee availability of a particular model or feature within your country.

Conforms to the Following:

FCC Rules

NOTE: This equipment has been tested and found to comply with the limits for a Class A digital device, pursuant to part 15 of the FCC Rules. These limits are designed to provide reasonable protection against interference when the equipment is operated in a commercial environment. This equipment generates, uses, and can radiate radio frequency energy and, if not installed and used in accordance with the instruction manual, may cause interference to radio communications. Operation of this equipment in a residential area is likely to cause interference in which case the user will be required to correct the interference at his own expense.

CAUTION: Changes or modifications to this equipment not expressly approved by the party responsible for compliance could void the user's authority to operate the equipment.

Shielded USB cables must be used with this equipment to ensure compliance with the limits. Use of unshielded USB cables is prohibited.

WARNING! This is a Class A product. In a domestic environment this product may cause radio interference in which case the user may be required to take adequate measures.



EMC Directive 89/336/EEC

Low Voltage Directive 73/23/EEC

Tested for compliance by TUV Rheinland Product Safety to meet regulatory requirements in USA, Canada, and Europe.

Also Conforms to:

Directive 2002/96/EC (OJ:L37/24/2003) on waste electrical and electronic equipment (The WEEE Directive)

Directive 2002/95/EC of the European Parliament and of the Council of 27 January 2003 on the restriction of the use of certain hazardous substances in electrical and electronic equipment.

Table of Contents

Contact Information List

USA Contacts.....	iii
Canada Contacts	iii
Other Country Contacts	iv

Chapter 1 - Introduction

Welcome to the DA70S/DA75S Ink Jet Printer	1-2
Using This Guide.....	1-2
System Requirements.....	1-2
Getting Help	1-3
Online Help.....	1-3
Printer Options.....	1-3
Important Safety Notes.....	1-4
Other Informational Cautions.....	1-5
Important Safety Notes for the EU Only	1-6
Printer Parts and Locations.....	1-7

Chapter 2 - Printer Basics

Printer Features Overview	2-2
Setting Up a Job.....	2-3
1. Setting the Separator Gap.....	2-3
2. Centering the Input Guide under the Material.....	2-5
3. Setting the Feed Angle.....	2-6
4. Setting the Feed Ramp	2-8
5. Position the Side Guide	2-9
6. Loading Material.....	2-10
7. Adjusting the Media Thickness Knob.....	2-11
8. Adjusting the Exit Rollers	2-12
9. Printing a Test Piece	2-13
Printer Driver Software.....	2-13
Selecting Printer Properties.....	2-13
Using the Control Panel	2-14
Using the Menus	2-15
Using the Main Menu.....	2-16
Using the Setup Menu	2-17

Table of Contents

Chapter 3 - Printer Maintenance

Preventive Maintenance	3-2
Print Quality Problems	3-2
Cleaning the Exit Rollers	3-3
Cleaning the Sensor	3-3
Cleaning the Printhead Shaft.....	3-3
Cleaning the Floor Assembly and Top Cover	3-4
Purging the Printhead	3-4
Installing and Removing the Ink Jet Cartridges.....	3-5
Installing the Ink Jet Cartridges (Color & Black).....	3-5
Removing the Ink Jet Cartridges	3-6
CMYK Printing Alignment (DA75S ONLY).....	3-8

Chapter 4 - Troubleshooting

Problems and Solutions	4-2
Feed Problems.....	4-2
Print Quality Problems	4-3
Interface Problems	4-4
Motor Problems.....	4-4
Barcode Problems.....	4-5
Other Problems	4-6

Appendix A - Specifications

Equipment Specifications	A-2
Material Specifications.....	A-9

Appendix B - Glossary

Glossary	B-1
----------------	-----

Index

Index	I-1
-------------	-----

Contact Information List



USA Contacts

Product Name - DA70S or DA75S

- For frequently asked questions, go to www.pitneybowes.com/us and click **Support**.
- To place requests for service or training, go to www.pitneybowes.com/us and click **Sign In**.
- To order supplies and accessories, go to www.pitneybowes.com/us and click **Buy Supplies**.
- To view and pay invoices online, go to: www.pitneybowes.com/us and click **Sign In**.

Canada Contacts

Product Name - DA70S or DA75S

- For frequently asked questions or to order supplies, go to: www.pitneybowes.ca/en

Contact Information List

Other Country Contacts

Contact information is given in a separate publication supplied with the product.

1 • Introduction



The DA70S/DA75S printer is a versatile, easy-to-use desktop printer designed for addressing applications. This chapter explains what's in this guide, and tells you how to order supplies and where to get more information about using your printer.

Welcome to the DA70S/DA75S Ink Jet Printer	1-2
Using This Guide	1-2
System Requirements	1-3
Getting Help	1-3
Online Help.....	1-3
Printer Options.....	1-4
Ordering Supplies	1-4
Important Safety Notes.....	1-5
Printer Parts and Locations	1-6

1 • Introduction

Welcome to the DA70S/DA75S Ink Jet Printer

The DA70S/DA75S ink jet printer is a desktop printer used to print addresses, graphics and other information, in color (DA75S only), on a wide range of material of various sizes, construction and composition. You can define the font, placement, print quality and barcode characteristics for your addresses.

Using This Guide

Refer to this guide for information about printer setup, operation and troubleshooting. It is divided into the following chapters:

Chapter 1, Introduction - Contains an overview of the Operator Guide, Help resources, safety information, as well as printer parts and locations.

Chapter 2, Printer Basics - Explains how to set up your printer to run a job.

Chapter 3, Printer Maintenance - Describes how to keep the printer clean and functioning properly.

Chapter 4, Troubleshooting - Contains a list of possible problems and their solutions.

Appendix A, Specifications - Provides hardware and material specifications. Your printer will run at its best when your material conforms to our specifications.

Appendix B, Glossary - Explains the meanings of common terms used with address printing equipment.

System Requirements

In order to operate the printer with your computer, your system must meet the following requirements:

CPU: Pentium III 500MHz. or greater, 500MB RAM or more preferred

Operating System: Windows 2000/2003 Server/XP

USB Cable or Ethernet Cable: A USB cable is supplied with your printer. If you choose to use another cable, make sure it isn't any longer than 16 feet (5m).

Getting Help

As you use your printer, there may be times when you need help to solve a specific application problem, or you may want additional information about printer operation.

Refer to the *Contact Information List* at the front of this guide for more information or in the separate contact sheet supplied with your machine.

Online Help

The Print Driver for your printer has a built-in help system. To get to the driver, click on **Properties** from Windows print dialog box. Right-click on items in question for the "What's This" Help button.

If you're using programs such as Envelope Designer™ or SmartMailer™, press the **F1** key while you're using the program to display information about the open screen. Select the **Help** menu to display a list of topics or search for a term. Refer to the documentation supplied with these programs for more information.

NOTE: The availability of software varies by country. Refer to your machine supplier for details of software available to you.

Printer Options

There are several options available for your addressing printer, such as ink drying equipment which may reduce smudging on glossy stock, stackers, and envelope designing software.

NOTE: The availability of software and product varies by country. Refer to your machine supplier for availability details in your country.

1 • Introduction

Important Safety Notes

Follow the normal safety precautions for all office equipment:

- It is recommended that you use only Pitney Bowes approved supplies, in particular aerosol dusters. Improper storage and use of aerosol dusters or flammable aerosol dusters, can cause an explosive-like condition that could result in a personal injury and/or property damage. Never use aerosol dusters labeled flammable and always read instructions and safety precautions on the duster container label.
- To obtain supplies, please contact our Supply Line™ to place orders. Material Safety Data Sheets can be obtained on the web or from our Supply Line™. Refer to the *Contact Information List* for more information.
- Use the power cord supplied with the machine and plug it into a properly grounded wall outlet located near the machine and easily accessible. Failure to properly ground the machine can result in severe personal injury and/or fire.
- Avoid touching moving parts or materials while the machine is in use. Keep hands, loose clothing, jewelry and long hair away from all moving parts.
- Do not remove covers or defeat safety interlock switches. Covers enclose hazardous parts that should only be accessed by properly trained service personnel. Immediately report to service any damaged or non-functioning components that renders the unit unsafe.
- Place the unit in an accessible location to allow for proper venting of the equipment and to facilitate servicing.
- The power cord wall plug is the primary means of disconnecting the machine from the AC supply.
- Do not use an adapter plug on the line cord or wall outlet.
- Do not remove the ground pin from the line cord.
- Avoid using wall outlets that are controlled by wall switches, or shared with other equipment.
- Do not route the power cord over sharp edges or trap between furniture.

- Ensure there is no strain on the power cord and that it does not become jammed between the equipment, walls or furniture.
- Be certain the area in front of the wall receptacle into which the machine is plugged is free from obstruction.
- Before clearing a jam, be sure machine mechanisms come to a stop.
- When removing jammed material, avoid using too much force to protect against minor personal injury and damaging equipment.
- To prevent overheating, do not cover the vent openings.
- Operation of this equipment without periodic maintenance will inhibit optimum operating performance and could cause the equipment to malfunction. Contact your machine supplier for required service schedule.
- Read all instructions before attempting to operate the equipment.
- Use this equipment only for its intended purpose.

Other Informational Cautions

NOTES:

- In case of an ink spill, leaking ink, or excessive ink accumulation, immediately disconnect the power cord plug from the wall outlet and call your machine supplier for a cleaning.
 - Always follow the specific occupational safety and health standards for your workplace.
 - Avoid using wall outlets that are controlled by wall switches, or shared with other equipment. If a wall outlet controlled by a wall switch is used, mail could be interrupted if the printer is plugged in when the wall switch is used to turn power off.
-

1 • Introduction

Important Safety Notes for the EU Only

In some countries the equipment is supplied with a moulded mains lead and plug. In other countries, or if the supplied lead is not used, the following information applies:

1. An approved mains lead for the country concerned must be used.
2. As the colours of the wires in the mains lead of this equipment may not correspond with the coloured markings identifying the terminals in your plug, proceed as follows:
 - The wire which is coloured green and yellow must be connected to the terminal in the plug which is marked with the letter “E” or by the earth symbol (\perp) or coloured green or green and yellow.
 - The wire which is coloured blue must be connected to the terminal which is marked with the letter “N” or coloured black.
 - The wire which is coloured brown must be connected to the terminal which is marked with the letter “L” or coloured red.
3. The wires in the supplied mains lead are coloured in accordance with the following code:
Green and Yellow - Earth
Blue - Neutral
Brown - Live



WARNING! THIS EQUIPMENT MUST BE EARTHED. The socket outlet should be near to the equipment and should be easily accessible.

Printer Parts and Locations

The figure below calls out key machine components, each of which is briefly described in the text that follows. Refer to the figure below for component location.

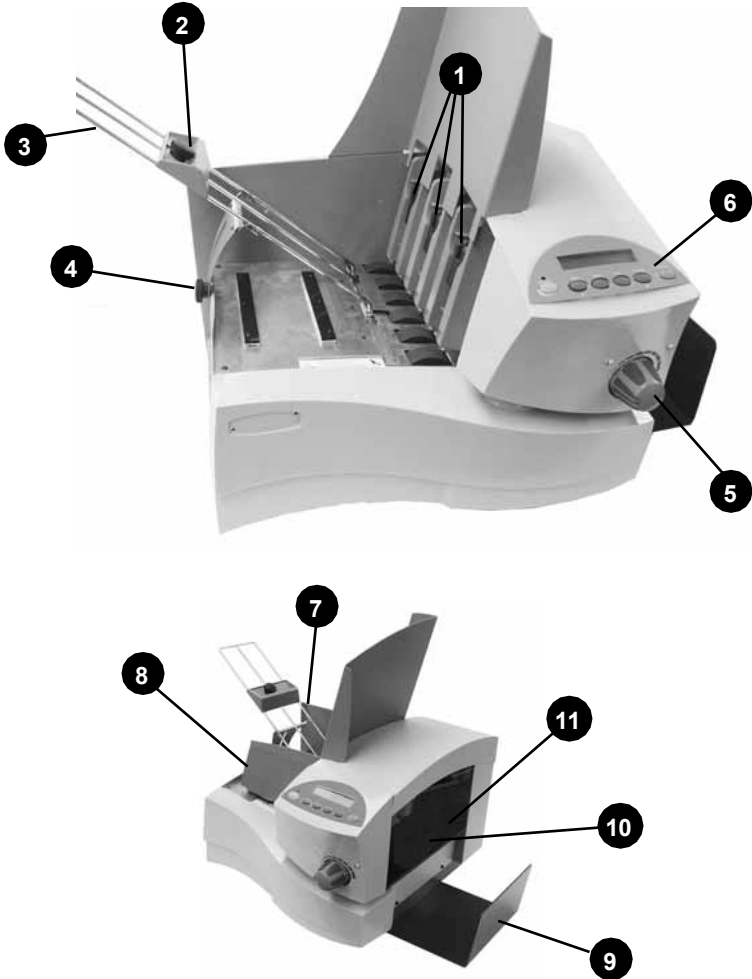

- 1 H-Block Separator** - Adjust to the thickness of your material. The gap between the H-Block separator fingers and the feed rollers should be just enough to allow a single piece to feed through the printer.

1 • Introduction

- 2 **Feed Ramp and Lock Knob** - The feed ramp adds a gentle slope to the stack to help feeding. Lower the ramp until the top of the bottom piece in the stack reaches the middle of the ramp. Secure the ramp with the lock knob.
- 3 **Input Guide** - Supports the material stack.
- 4 **Input Guide Slide and Lock Knob** - Move the slide up and down to adjust the feed angle to accommodate the weight of the material you're running. Move the slide forward and back to adjust its side-to-side position of the input guide so it's centered under the stack. Secure the slide with the lock knob.
- 5 **Media Thickness Knob** - The media thickness knob sets the distance between the printhead and the material.
- 6 **Control Panel** - Use the control panel buttons to access printer menus, define print options, run the print job, position the print carriage and turn the printer on and off line.
- 7 **Interface Panel (Not Shown)** - Located on the lower part of the rear cover, the panel has the ON/OFF switch, USB and Ethernet cable connectors and power cord receptacle. See figure on page 1-9.
- 8 **Side Guide** - Helps confine the stack. Adjust to the width of your material plus 1/16" (2mm) clearance.
- 9 **Output Stacker Tray** - Printed material is deposited in the stacker (catch) tray. The tray holds about 5" (130mm) of material.
- 10 **Printer Area Door Assembly (Not Shown)** - Open to gain access to the printer cartridges and exit rollers. See figure on page 1-9.
- 11 **Exit Rollers (Not Shown)** - Guides the printed material as it exits the printer. Adjust so that each roller overlaps the edge of the material by 1/4" (6mm). See figure on page 1-9.

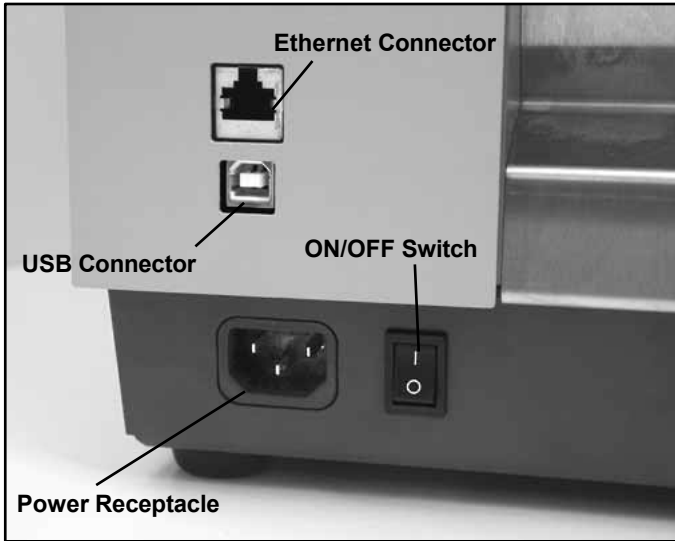

Printer Interface Panel

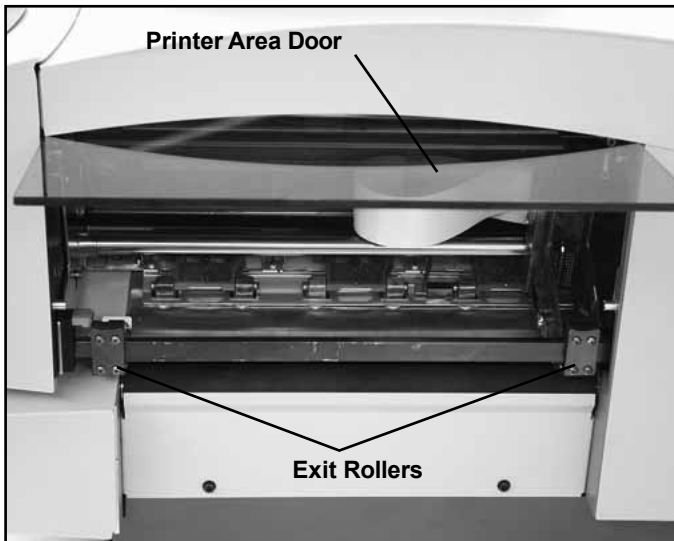

Exit Rollers and Printer Area Door (Open)

1 • Introduction

This page is intentionally blank.

2 • Printer Basics



In this chapter you'll learn about key printer features and how to adjust it to meet the requirements of your print jobs.

Printer Features Overview	2-2
Setting Up a Job	2-3
1. Setting the Separator Gap	2-3
2. Centering the Input Guide under the Material.....	2-5
3. Setting the Feed Angle	2-6
4. Setting the Feed Ramp	2-8
5. Position the Side Guide	2-9
6. Loading Material	2-10
7. Adjusting the Media Thickness Knob.....	2-11
8. Adjusting the Exit Rollers	2-12
9. Printing a Test Piece	2-13
Printer Driver Software	2-13
Selecting Printer Properties.....	2-13
Using the Control Panel.	2-14
Using the Menu.	2-15
Using the Main Menu.....	2-16
Using the Setup Menu	2-17

2 • Printer Basics

Printer Features Overview

This section provides a brief overview of the printer features. Refer to *Appendix A, Specifications*, for detailed specifications for the printer, including specific requirements for using each type of material.

Speed (pieces per hour)

Printer speed refers to the number of pieces of mail that can be processed in an hour. The printer can process up to 14,000 #10 or DL envelopes per hour, depending on the address content and configuration. Printer speed depends on the number of characters per line, the number of lines, character size, font, interface, barcode, material size and graphics.

Print Qualities

Draft, Letter, Executive with optional Light Mode

Internal Fonts

13 (14 including Code 3 of 9 Barcode).

Font Size

Font size refers to the size of each typeface. The printer uses from 4 to 144 point size for internal or downloaded fonts.

Media Size

The printer can print on the following range of material sizes.

	Width	Height	Thickness
Minimum	3.5" (89 mm)	3.5" (89 mm)	.003" (.08 mm)
Maximum	15.5" (394 mm)	15" (381 mm)	.25" (6.35 mm)

Approved Media Types

The printer can be used with envelopes, booklets, catalog envelopes, postcards, self-mailers, and paper. All envelopes must be without windows. Any folded material needs to be tabbed.

Setting Up a Job

Setting up a print job means adjusting the printer to accommodate the width, height, thickness and weight of your material.

There are two things that determine how reliably your printer feeds: the setup adjustments and the quality of your material. A good setup minimizes misfeeds and jams. And your printer will perform at its best when you run material that falls within our published specifications. Please see *Appendix A, Specifications* for complete material specifications.

1. Setting the Separator Gap

Whenever you switch from one material type to another, you need to set the gap between the separators and the feed roller before printing begins.

NOTE: There are three positions of the "H" Blocks.

- Lever fully down - adjusted to media thickness (ready to operate).
- Lever midpoint - not adjusted to any media (free floating on media, not set up to operate).
- Lever fully up - locked in the up position, not adjusted to any media thickness.

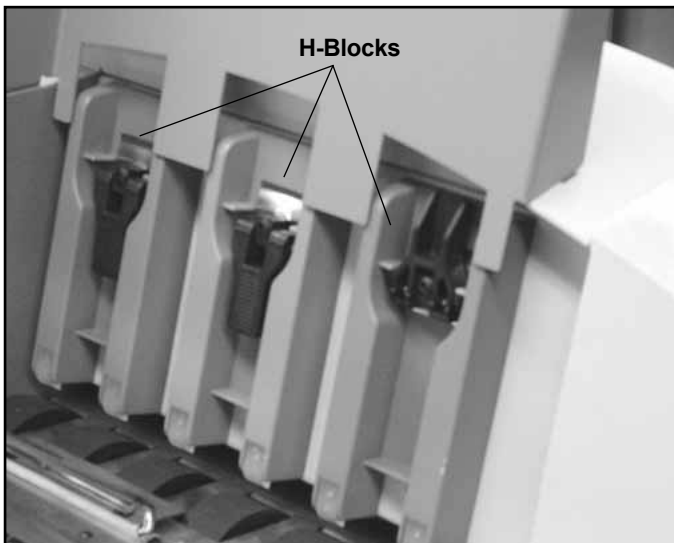

2 • Printer Basics

Setting the Proper Feed Gap

- A. Loosen the lock knobs to unlock all three H-Blocks.
- B. Lift the H-Blocks to their highest position and lock in place.
- C. Place a sample piece of material between the separator fingers (the lower section of the H-Blocks) and the feed roller.
- D. Lower only the H-Blocks that come in direct contact with the material and let them touch the material.
- E. Lock each separator in place. When lowering the H-Blocks, check that the material is between the separator tabs and the feed roller.

Setup Example Using #10 or DL Envelopes:

- A. When you set the feed gap for a #10 or DL envelope, note that the width of the envelope will fall completely under the inside and middle H-Blocks, but only half way under the outer H-Block. Follow steps B through D to fix this.
- B. Remove the side guide.
- C. Place a second envelope next to the first, under the outer H-Block. Place the second envelope flap down with the short edge under the outer H-Block.
- D. Lock the separator in place.

NOTE: If the separator gap is not set properly, the printer will misfeed.

- If the gap is too big, the printer will feed doubles (two or more pieces at the same time).
 - If the gap is too small, material will jam at the feed roller entrance.
-

2. *Centering the Input Guide under the Material*

This adjustment helps eliminate skewing.

- A. Place a sample piece of material in the feed area, up against the support plate.
- B. Unlock the knob on the input guide slide by turning counterclockwise.
- C. Slide the input guide forward or back as required to center it under the sample piece of mail.
- D. Turn the lock knob clockwise to secure the input guide.

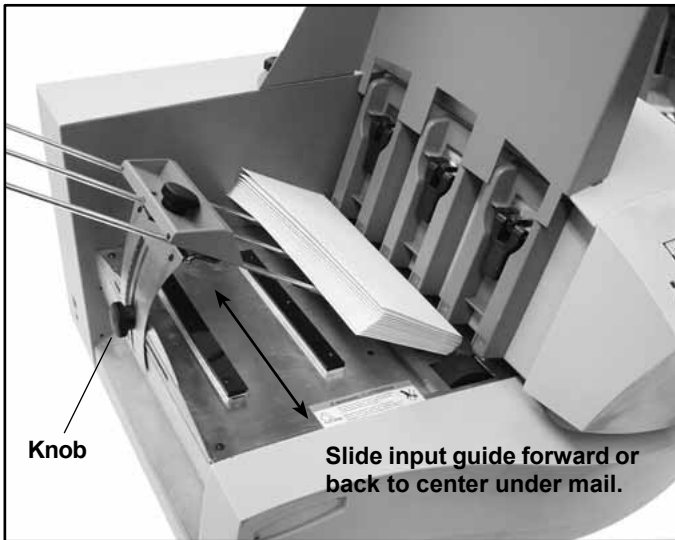

2 • Printer Basics

3. *Setting the Feed Angle*

The height of the input guide depends on the type of material you're running:

- Heavy material—adjust to a low angle
- Standard material—adjust to the center (45 degree angle)
- Light material—adjust to a high angle

To make the adjustment:

- A. Unlock the knob on the input guide slide by turning counterclockwise.
- B. Move the input guide up or down as required by sliding the retaining knob.

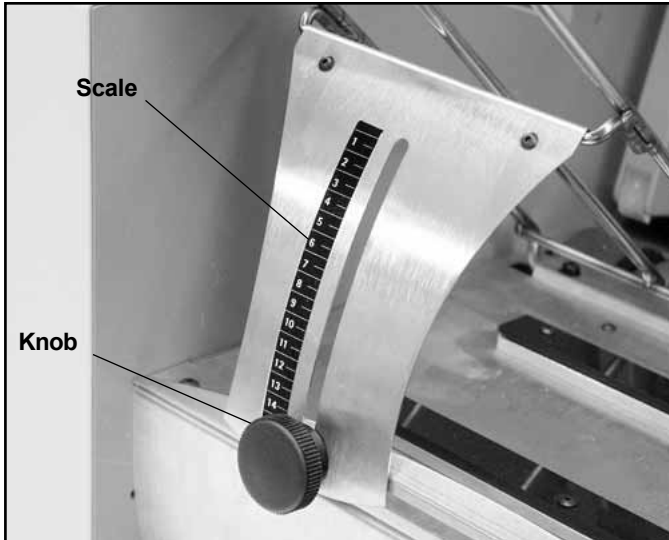

- C. Turn the lock knob clockwise to secure the input guide.

NOTE: Center line of the knob aligns with relative number of the scale. Refer to the scale on following page.

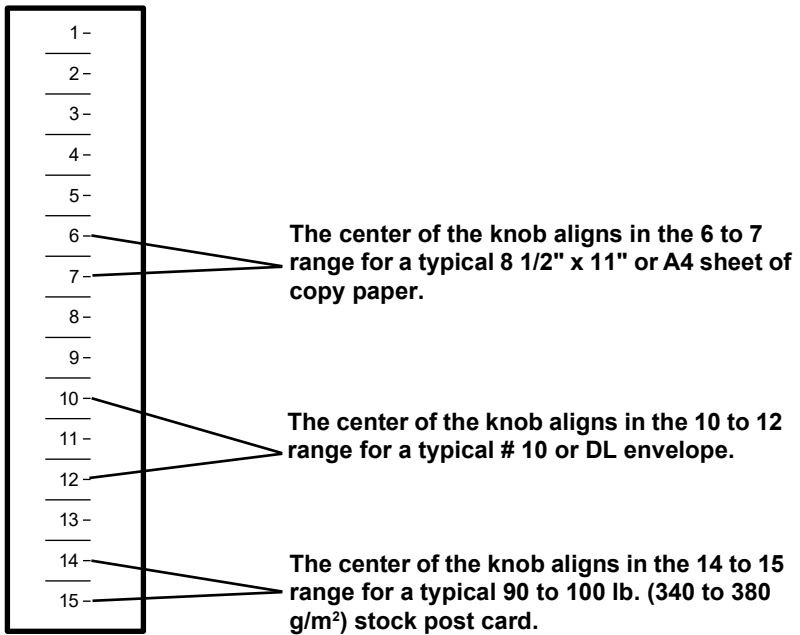

NOTE: The settings shown above are suggested settings. You can adjust the input guide accordingly (up or down) until the desired feed throughput is achieved.

2 • Printer Basics

4. *Setting the Feed Ramp*

- A. Slide the ramp to the top of the input guide.
- B. With the Feed Gap properly set for one piece of media, slide the ramp down.
- C. Add a stack of media and adjust the ramp downward until the first piece of media is resting half way down the angle of the ramp surface as pictured below.

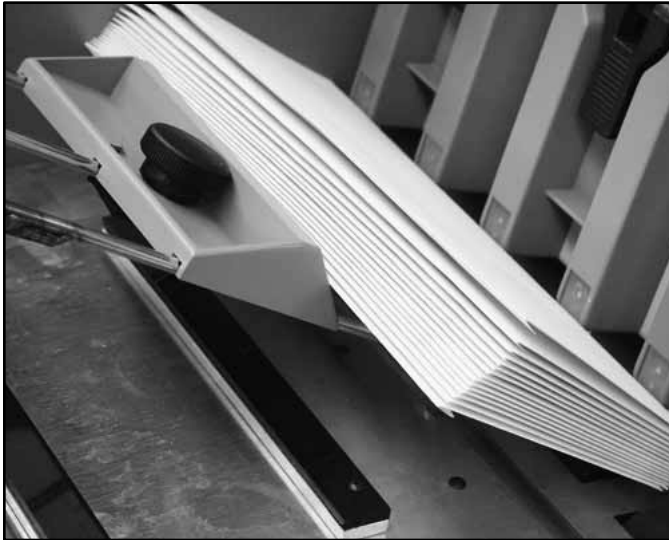

NOTE: This picture is shown without the side guide, for ease of illustration.

5. Position the Side Guide

Your printer comes with two side guides—a long one and a short one. Use the long side guide for #10 or DL envelopes and larger materials. Use the short side guide for materials smaller than a #10 or DL envelope.

It is important that the side guide not be adjusted tight against the media.

To position the side guide:

- A. Place a sample piece or trial stack of material in the input area.
- B. Slide the side guide until it almost touches the stack of material.
- C. Check that there's about 1/16" (2mm) clearance (the thickness of a dime) between the side guide and the stack.

NOTE: Proper clearance is important. If you push the side guide tight up against the stack, it could impede feeding and cause jams. If the clearance is too great, pieces could skew as they feed into the printer.

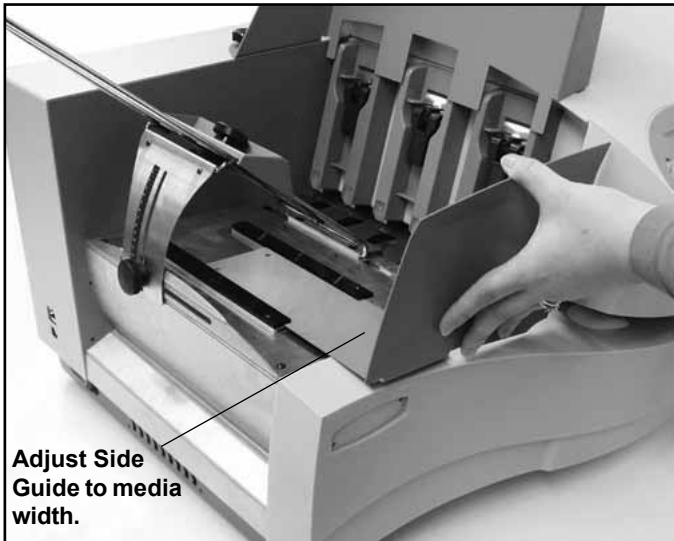

2 • Printer Basics

6. Loading Material

Once your printer is set up, you can load material and make a test print. Avoid misfeeds by following these precautions:

- A. Make sure the input area is free of dust and other matter.
- B. Take a manageable amount of material and while holding it as shown, fan all sides of the material to separate each piece. This step helps keep misfeeds to a minimum.
- C. Tamp the material on a flat surface, making sure that the stack is square.
- D. Shingle the stack as you load it into the input area. Load envelopes so the side to be printed faces up. Flaps should be down and oriented away from the feed roller (flaps trailing).



- E. Position the right edge of the envelopes flush against the support plate. Begin with just a few envelopes to start the stack and get the proper contour, then add several more pieces. Then, add the remainder of the stack.

NOTE: Envelope feeding is generally more reliable if there are more than just a couple of envelopes in the input bin.

- F. Adjust the position of the feed ramp as described in this chapter.

7. Adjusting the Media Thickness Knob

The media thickness knob sets the distance between the printhead and the material. Use it to compensate for different material thicknesses and to increase clarity of the printing.

- A. Estimate the thickness of the material to be run.

NOTE: All material in a run must be the same thickness. For envelopes with 0 - 2 inserts, start with the media thickness knob set as shown below. For 1/4" (6mm) thick material, start with setting all the way at the Thick side. For 1/8" (3mm), start 1/2 way.

- B. While running test samples, turn the knob counter-clockwise to close the gap until the desired quality of printing is obtained.

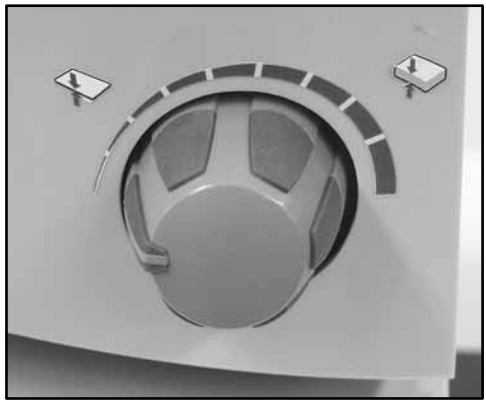

NOTE: Adjusting the media thickness knob too far counter-clockwise may cause smearing or jamming.

A NOTE ABOUT PRINT QUALITY: This printer is designed to feed and print on a range of materials with various finishes and coatings. However, the sharpness of the print may vary with different materials, depending on how absorbent the surface is, as well as other qualities.

You'll get best results using white wove bonded stock. Printing is less sharp on Tyvek, recycled and glossy material. It is also possible that ink may not dry thoroughly on certain very glossy materials. Always test high gloss materials for their drying qualities before you buy them in quantity and attempt to run a print job.

2 • Printer Basics

8. Adjusting the Exit Rollers

Adjust the exit rollers so they overlap the left and right edges of the material by 1/4" (6mm). Rotate the release lever to vertical then slide the rollers from side to side to make the adjustment and press the lever down to lock. Must be down and latched to operate.

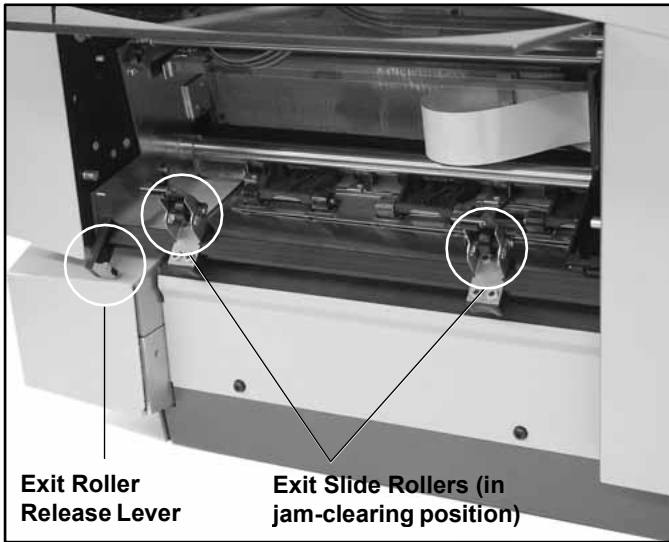

IMPORTANT: Make sure the rollers do not touch any printed area of the material. If this happens, the rollers will act like a printing press and imprint a faint impression at incremental distances on the material. If this happens, move the roller or rollers toward the nearest clear zone, that is, an area free of printing.

Output Stack Height

The output stacker holds up to five inches of material before it becomes necessary to remove the stack from the bin. The optional power stacker increases capacity to 300 #10 or DL envelopes.

NOTE: As the stack approaches the 5" (130mm) limit, there is a potential for stacking misfeed (pieces not neatly stacked one on top of the other). This can cause envelopes to stack out of printed sequence.

9. *Printing a Test Piece*

Print a test piece to ensure the material is loaded properly. (Or you can use a single test piece if you'd like to check your setup adjustments.) Use the Control Panel keys to print a test piece. Refer to *Using the Control Panel* in this chapter for more information.

Check the print quality. If it's not what you want, adjust the media thickness lever as required and run another test piece. When you're satisfied with the setup adjustments, you're ready to run the job.

Printer Driver Software

Before you can use your printer with your computer, you must install a printer driver. The driver gives your computer information about the printer you're using, and tells the printer about the settings you want to use in your print job.

If you have not previously installed the printer driver on your computer, refer to the installation instructions furnished with it.

The printer drivers are contained on a CD that comes with your printer. To set up, follow the instructions as shown in the installer.

Selecting Printer Properties

This section describes printer properties and use of the windows for selecting the available options. To access the main properties window, follow these steps:

1. Click the **Start** button in the task bar, then select Settings.
2. Click **Printers**. The Printer window displays.
3. Right click the **Pitney Bowes** printer icon, then left click the **Properties** option.

The *Properties* window opens and displays seven tabs, each of which allows access to different printer options. An explanation of the items on each tab is available by doing the following:

- Right click an item to display the "What's This" button.
- Right or left click this button to display the information about the selected item.

Options may differ depending on which software drivers are used.

2 • Printer Basics



Using the Control Panel

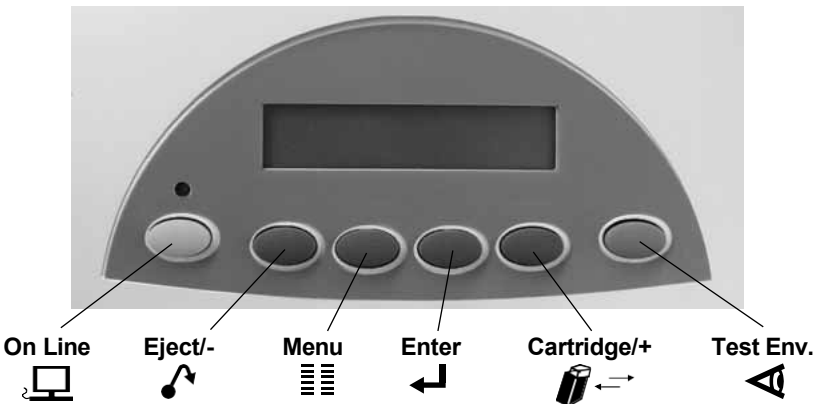

Use the buttons on the control panel to get to the printer menus, define the print options, run a print job, position the print carriage and turn the printer ON LINE and OFF LINE. You'll normally perform these actions from within the application you're using to set up your envelope layout.

NOTE: You also have a PC Control Panel which allows you similar functionality to the LCD menus. The Control Panel also has online help.



The buttons on the control panel perform the following functions:

This Button...	Does This...
ON LINE 	Toggles (switches) between ON LINE (communicates with host) and OFF LINE (no communications with host). Note that the functions of two buttons, Eject/- and Cartridge/+, vary, depending on whether the printer is ON LINE or OFF LINE .
Eject/- (minus) 	When printer is OFF LINE, press to eject the last printed piece from the printer. When printer is OFF LINE, press to scroll through menu items from bottom to top printer.
Menu 	Displays the options on the Main Menu and the Setup Menu. The printer must be OFF LINE to access the menus.

This Button...	Does This...
Enter 	Press to select the currently displayed menu option.
Cartridge/+ (plus) 	With the printer OFF LINE, press to move the ink cartridge holder to the center of the printer. This makes it easy to remove the cartridge. With the printer OFF LINE, press to scroll forward through the menu options.
Test Env. 	With the printer OFF LINE, press to print a test envelope.

Using the Menus

The printer has two menus, both displayed on the LCD:

- Use the Main Menu to control how your printed material looks.
- Use the Setup Menu to configure your printer so it will function correctly with your computer.

NOTE: The printer must be OFF LINE to access the menu options.

To select an option:

1. Press the **ON LINE** button until the LCD message displays OFF LINE.
2. To access the MAIN MENU, press the **Menu** button.
3. To access the SETUP MENU, press and hold the **Menu** button for four (4) seconds.
4. Press the **plus (+)** or **minus (-)** buttons to move through the list of menu options.
5. When the appropriate menu option appears, press the **Enter** button to display the choices associated with that option.
6. Press **+** or **-** to scroll through the choices. When an option has an asterisk (*) in front of it, means that option is presently selected. (Upon receipt from the factory, the asterisk is typically the default setting.) When you press the **Enter** button to define a new option, an asterisk will appear before the selected option.
7. Press the **Menu** button several times to back out of the Menu until the printer displays OFF LINE. Then press the **ON LINE** button to print

2 • Printer Basics

Using the Main Menu

The Main Menu options are:

MAIN MENU	MENU OPTIONS
1. ADDRESS LAYOUT	A. DISTANCE TO RIGHT B. DISTANCE TO BOTTOM C. LINE SPACING D. INVERTED PRINTING E. ORIENTATION F. ORIENTATION CONTROL
2. PRINT QUALITY	A. QUALITY B. LIGHT MODE
3. FONT	A. NAME B. SIZE C. BOLD D. ITALIC
4. BARCODE (U.S. Only)	A. LOCATION B. 9 DIGIT ON/OFF C. BAR WIDTH
5. ADDRESS RECOVERY	A. GET ADDRESS (BATCH) B. GET ADDRESS (INTER) C. CLEAR MEMORY
6. CLEAR COUNTER	
7. IMAGE OVERLAY	A. CAPTURE OVERLAY B. CLEAR OVERLAY C. PRINT OVERLAY

NOTE: The settings you define in a software application such as SmartMailer™ override any settings you choose in the printer menus.

Using the Setup Menu

The Setup Menu Options are:

SETUP MENU	MENU OPTIONS
1. HEAVY MEDIA MODE	
2. TEST PRINT HEAD	
3. PURGE PRINT HEAD	
4. LINES PER ADDRESS	
5. COMMUNICATIONS	A. TCP/IP B. LINE TERMINATION
6. HEX DUMP MODE	
7. LANGUAGE	A. SYMBOL SET B. INCH/MILLIMETER C. MENU LANGUAGE
8. ENVELOPE FEED DELAY	
9. ENVELOPE AUTO EJECT	A. AUTO EJECT MODE B. DELAY
10. ROM REVISION #	
11. PRINT HEAD MAINT	A. HEAD MAINTENANCE B. MAINT. CYCLE TIME
12. BUNDLE BREAK 13. TRAY BREAK	A. ENABLE/DISABLE B. BREAK CHARACTER C. BREAK CHARACTER COUNT D. CHAR. ORIENTATION E. BREAK LOCATION F. PRINT BRK CHARS G. BRK PAUSE TIME
14. LOW INK WARNING	A. DISPLAY WARNING B. WARNING THRESHOLD C. STOP WHEN EMPTY
15. LOGGING SETTINGS	A. ENABLE LOGGING B. LOGGING LEVEL C. PRINT LOG

NOTE: To print a list of the Main Menu and Setup Menu settings, press the **Test** button when ROM REV is displayed.

2 • Printer Basics

This page is intentionally blank.

3 • *Printer Maintenance*



This chapter describes the maintenance procedures you should perform on a regular basis to keep your printer running trouble-free.

Preventive Maintenance	3-2
Print Quality Problems	3-2
Cleaning the Exit Rollers.....	3-3
Cleaning the Sensor.....	3-3
Cleaning the Printhead Shaft	3-3
Cleaning the Floor Assembly and Top Cover.....	3-4
Purging the Printhead	3-4
Installing and Removing the Ink Jet Cartridges	3-5
Installing the Ink Jet Cartridges (Color & Black).....	3-5
Removing the Ink Jet Cartridges	3-6
CMYK Printing Alignment (DA75S ONLY)	3-8

3 • Printer Maintenance

Preventive Maintenance

The Ink Jet Printer is designed for trouble-free service with a minimal amount of care. You should schedule regular cleaning of the Feed Rollers, Exit Rollers and Lower Guide.



CAUTION:

- Clean print head, cartridge, ink surfaces and covers with plain water only. (Water works best!)
 - Clean all rubber rollers with isopropyl, denatured and rubbing alcohol only.
 - Use of any other cleaning solvents will void all warranties.
 - Keep petroleum based cleaning solvents away from rubber or plastic parts. Anything but alcohol will cause premature breakdown of the rubber compound.
-

Print Quality Problems

The print head performs a self-cleaning cycle periodically. If print quality is unacceptable, try the following:

- Adjust the media thickness lever to see if print quality improves.
- Clean the print head cartridge: dampen a soft cotton cloth with water and wipe the nozzles clean.



Correct



Incorrect

- From the Setup Menu, select 3. Purge Printhead. The purging process clears any clogged ink on the print nozzle. Often this returns the print quality to a normal level. See *Purging the Printhead* in this chapter for more information.
- Install a new ink cartridge. See *Installing and Removing Ink Jet Cartridges* in this chapter.

Cleaning the Exit Rollers

If the right and left exit rollers are misaligned, that is, contact printed surfaces, they can become contaminated with ink. Use water to dampen a soft cloth and remove the ink from the rollers.

Cleaning the Sensor

A film and/or dust can build up on the sensors and cause misfeeds of the material. Lift the transport door and use compressed air to blow dust from the sensors. Cans of compressed air are available from many computer supply houses.

Cleaning the Printhead Shaft

Periodically wipe the printhead shaft clean with a dry, soft, lint free, cotton cloth. DO NOT OIL!

Printhead Shaft



Sensor

3 • Printer Maintenance

Cleaning the Floor Assembly and Top Cover

Periodically wipe the cover and floor assembly (feed deck) with a soft cotton cloth, dampened with water only.

Purging the Printhead

1. To access the SETUP MENU, press and hold the **Menu** button for four (4) seconds.
2. Press the **+** or **-** buttons to scroll through the SETUP MENU options until 3. *PURGE PRINT HEAD* appears on the LCD panel.
3. Press the **Enter** button to select this option.
4. To select Purge Printhead cycle, press **Enter** when the "Purge Printhead?" message displays.
5. Press the **+** button (YES) to enable this option. The printer will display "Please wait...print head being purged".
6. Press the **Menu** button to back out of the menu until printer displays "OFF LINE". Then press the **ON LINE** button to enable the printer.

Installing and Removing the Ink Jet Cartridges

Installing the Ink Jet Cartridges (Color & Black)

The printer uses Ink Jet Cartridges for printing. You must install a black only cartridge (DA70S), or a black and a color cartridge (DA75S), before you can print. To begin:

1. With the printer on, press the **ON LINE** key until the display reads OFF LINE.
2. Open the back cover of the printer.
3. Press the **Cartridge/+** key on the control panel to move the carriage to the middle of the printer. *Do not attempt to move the carriage by hand.* Doing so can result in damage to the carriage assembly.
4. Remove the cartridge from its shipping container by peeling the top cover off. Be careful not to touch the gold contacts.



WARNING! The ink in the cartridge may be harmful if swallowed. Keep new and used cartridges out of reach of children. Discard empty cartridges immediately.

5. Gently remove the tape covering the ink nozzles on the print cartridge, being careful not to touch the copper nozzles.
6. Gently insert the cartridge (color to the right, black to the left-DA750 only) into the carriage at approximately a 20 degree angle with copper strip to the bottom and in first. Press down on the cartridge until it is seated.

NOTE: The print cartridge photos in this section are of the DA75S printer. The DA70S has only one cartridge.



3 • Printer Maintenance

7. Push the cartridge forward (away from you) until it snaps in place.

IMPORTANT: When installing cartridges on the DA75S, please immediately perform the CMYK Printing Alignment procedure in this chapter.

Removing the Ink Jet Cartridges

To remove or replace the ink jet cartridges, follow these steps:

1. With the printer on, press the **ON LINE** button until the printer displays "OFF LINE".
2. Open the printhead cover.
3. Press the **Cartridge/+** key on the control panel. This moves the carriage to the middle of the printer. Do not move the cartridge by hand.



4. To remove the ink jet cartridge, place your thumb on the grooved surface and press down slightly then tilt towards you until it pops loose.
5. Lift the print cartridge out of the cradle.



3 • Printer Maintenance

CMYK Printing Alignment (DA75S ONLY)

Your DA75S printer allows black (K) to print with color (CMY) at the same time (known as CMYK printing). To ensure proper printing, the black (K) and color cartridges (CMY) need to be correctly aligned. The alignment procedure should be done whenever you replace any of your cartridges. Follow this procedure to align the cartridges:

1. Turn ON the DA75S. When the startup completes, the "ON LINE" screen displays.
2. Press the **Cartridge/+** button.
3. Replace the ink print cartridge (if you haven't done so already). The "Press a key when print heads replaced" prompt displays. Press any key to continue.
4. When the "Reset color (or black) Ink..." prompts displays, press **Cartridge/+** to reset the ink if you have just installed a new cartridge; otherwise, press **Eject/-** if all you need to do is the alignment procedure.
5. When the "ALIGN INK CARTRIDGES" prompt displays, press (+).
6. When the "--COLOR ALIGNMENT--" prompt displays, insert an envelope into the printer and press **Enter**.
7. The "Horiz adjust" prompt displays and the sample shown below prints on the envelope.

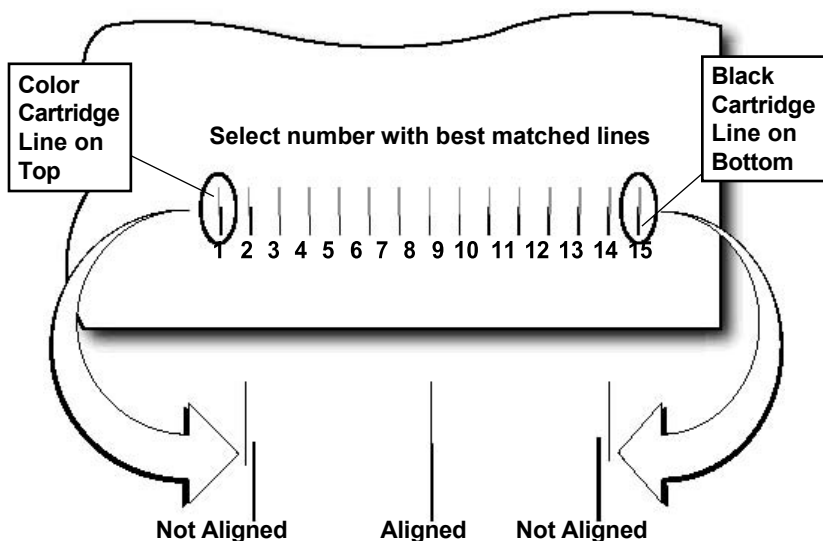

- Press the (+) or (-) buttons to scroll through the selections and choose the number that represents the best horizontal alignment of the upper and lower lines (for the color and black cartridges, respectively).
- Insert an envelope into the printer and press **Enter**. The horizontal adjustment prompt displays and the sample shown below prints on the envelope.

NOTE: The number you selected is highlighted (underlined) and all lines on the envelope should now be aligned.

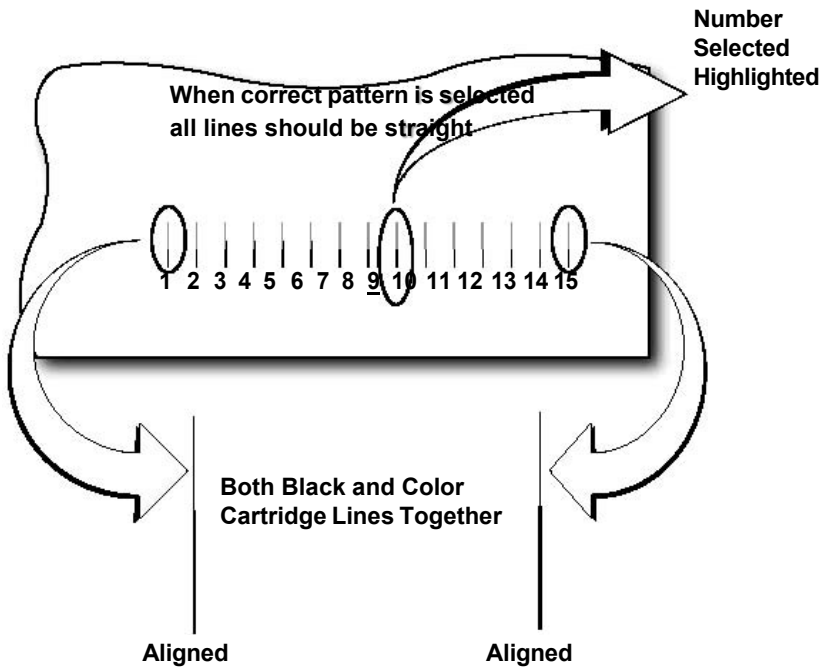

- Press **MENU** to return to the alignment choice window
- Press (+) or (-) to move to the vertical alignment screen.
- Insert an envelope into the printer and press **Enter**. The vertical adjustment prompt displays and the sample shown on the next page prints on the envelope.

3 • Printer Maintenance

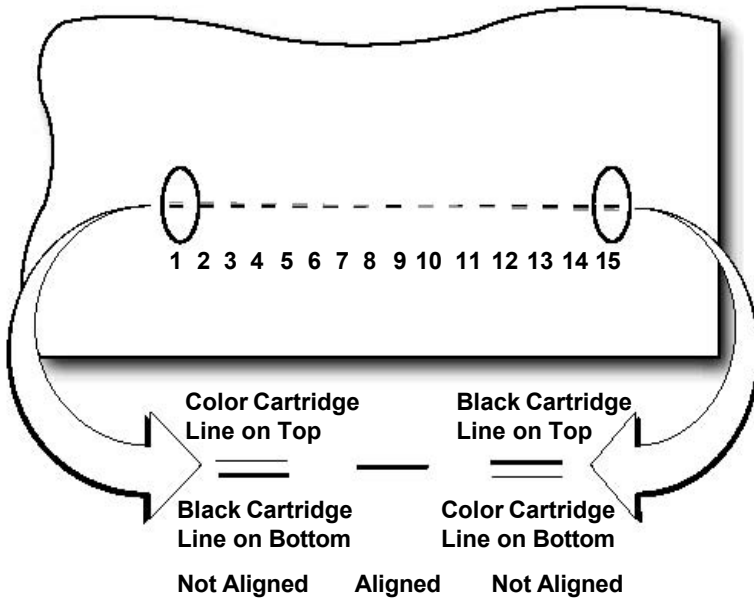

13. Press (+) or (-) to scroll through the selections and choose the number that represents the best vertical alignment of the upper and lower lines (for the color and black cartridges, respectively).
14. Insert an envelope into the printer and press **Enter**. The vertical adjustment prompt displays and the sample shown on the next page prints on the envelope.

NOTE: The number you selected will be highlighted and all lines on the envelope should now be aligned.

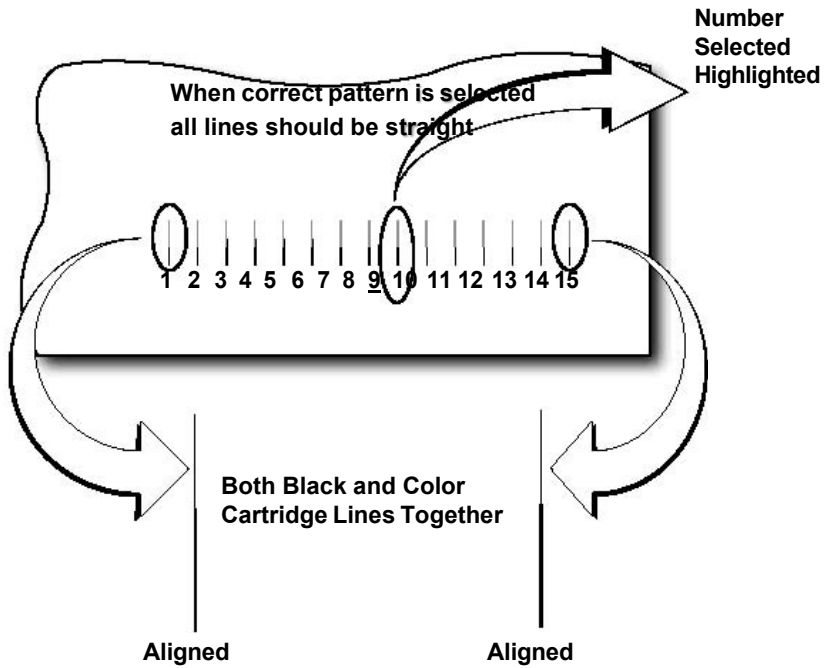

15. Press **Menu** twice to return to the normal ON LINE screen.

3 • Printer Maintenance

This page is intentionally blank.

4 • Troubleshooting



This chapter lists some common printer problems and offers suggestions on how to fix them.

Problems and Solutions	4-2
Feed Problems.....	4-2
Print Quality Problems.....	4-3
Interface Problems.....	4-4
Motor Problems	4-4
Barcode Problems	4-5
Other Problems.....	4-6

4 • Troubleshooting

Problems and Solutions

Before calling for service, look for your problem below. If you can solve the problem yourself, you will be able to resume printing sooner.

Feed Problems

Problem	Reason	Solution
Intermittent Feed	Feed Ramp not used.	The feed ramp adds a gentle slope to the stack and helps feeding. If you're using the ramp, check the H-Block gap for proper separation. Also make sure the wire frame is centered under the material. <i>See Chapter 2, Printer Basics for more information.</i>
	Dirty feed rollers.	Clean the feed roller with alcohol. DO NOT use any other solvents or detergents. They could damage the feed rollers.
	Paper dust present (yellow or white residue), blocking feed sensor.	Clean sensor with compressed air. <i>See Chapter 3, Printer Maintenance for more information.</i>
	Too much material in feeder (too heavy). Weight of stack must be 20 lbs. (9kg) or less.	Remove some material from stack.
Multi feeds (Feeds Doubles) or Skewing	Separators (H-blocks) not set correctly. Side guide set incorrectly.	Adjust H-Blocks to thickness of material. Check side guide position. <i>See Chapter 2, Printer Basics for more information.</i>
	Media thickness knob set too thick.	Reduce setting.

Print Quality Problems

Problem	Reason	Solution
No Print	Ink cartridge problem.	Purge ink cartridge. See <i>Chapter 5, Printer Maintenance</i> for more information. Clean cartridge jets with soft cotton cloth and water. Change to a new cartridge(s)
Grey or Light Print—Black Ink Off Color or Low Ink Intensity - Color Ink DA75S Only	Ink supply is low.	Check adjustment of the media thickness knob. If this fails to correct the problem, replace ink cartridge. See <i>Chapter 3, Printer Maintenance</i> for more information.
Address Smudging	Incorrect media thickness knob setting. Ink may not dry on very high gloss material.	Check whether media thickness knob is adjusted too low. Try using less glossy material. Check exit idler rollers.
Address Printing is not Sharp	Incorrect media thickness knob setting. Also, unsuitable material	Check whether media thickness knob is adjusted too high. Print quality is less sharp when using Tyvek®, recycled or glossy media.
Unwanted Bolding	Escape sequence turning on bold or bold selection in printer's menu options is set to bold.	Turn off bolding in software and/or turn bold selection in printer menu OFF. Refer to help system provided with printer for more information. If problem still exists, call for service.
Addresses "Walking"	Incorrect address setup.	Count carriage returns and line feeds and adjust Lines Per Address to the same number. Also check line termination: Typical, CR=CR; LF=LF. Other choices, (CR=CR+LF; LF=LF), CR=CR; LF=CR+LF), (CR=CR+LF; LF=CR+LF), double spacing.

4 • Troubleshooting

Interface Problems

Problem	Reason	Solution
Printer Not Responding	Incorrect printer driver, bad USB or Ethernet connection, bad printer controller board.	Use appropriate printer driver; replace USB or Ethernet cable. Make sure cable connections are tight. If the problem still persists, call for service. Clear memory. Cycle power (turn printer off, then on).

Motor Problems

Problem	Reason	Solution
Motor Turning but No Feed Roller Movement	Mechanical problem.	Call for service.

Barcode Problems

Problem	Reason	Solution
Barcode (Lower Right) is not Printing (U.S. Only)	Barcode not enabled.	Turn barcode ON using Envelope Designer™ Plus, the appropriate print driver or the printer's control panel menus.
	Missing ZIP Code.	Insert ZIP Code.
	Invalid ZIP Code format.	Check ZIP Code for invalid character. Example: Zero (0) can only be the number, not the letter (O). Verify that there is a dash inserted between the 5 + 4 ZIP Code per local postal specifications.
	Address too low.	Verify the bottom of the last line of the address field is not less than 5/8" (16mm) from bottom edge of the media.
Address too High	Address field is within 1/10" (2.5mm) of the top edge of the media.	Move address field down to within local postal specifications.
Barcode Fails MERLIN Standards at USPS (U.S. Only)	Mail does not meet barcode, address placement, or other acceptance tests of MERLIN (Mail Evaluation Readability Look-up Instrument) at USPS.	Visit our web site for more information about MERLIN. Click on Customer Support , then search the database for <i>MERLIN</i> .

4 • Troubleshooting

Other Problems

Problem	Reason	Solution
Paper Out or Paper Jam	Input area is empty.	Refill the input area.
	H-Block separators not adjusted correctly.	Adjust the H-Blocks to the thickness of the material you're running. See page <i>Chapter 2, Printer Basics</i> for more information.
	Paper jam obstructing paper path.	Clear obstructed paper path.
	Dirty paper feed sensor.	Clean sensor with compressed air. See page <i>Chapter 2, Printer Basics</i> for more information.
Shuttle Jam	Media thickness knob is set too low for material.	Open the transport door and adjust the media thickness knob. See page <i>Chapter 2, Printer Basics</i> for more information.
	Lower rail shaft dirty	Wipe lower rail shaft clean.
Out of Memory	The printer can run out of memory when downloading fonts or graphics.	This generally means you're trying to use a graphic (artwork) that's too big or you have too many fonts or too large a font size. If the out-of-memory message appears, try reducing the size of your art and limiting the number and size of your fonts. Then shut the printer OFF, then ON and retry.

Appendix A • Specifications



This Appendix contains detailed hardware and material specifications for the printer.

Equipment Specifications.....	A-2
Material Specifications.....	A-9

Appendix A • Specifications

Equipment Specifications

Physical Dimensions

13" (33 cm) high; 19" (48 cm) wide; 17" (43 cm) deep (without input guide).

Weight

50 lbs. (23 kg), including high-capacity print cartridges and catch bin.

Electrical

100-240 Vac, 50/60 Hz., 5.0A

Agency Approvals

cTUVus/TUV Rheinland-GS - Refer to the FCC and CE statements at the front of this guide for more information.

Interface

USB and Ethernet

Control Language

PCL5, modified

Address Recovery

Memory buffer holds a maximum of 99 addresses

Print Modes (Print Resolution)

The printer has three print resolutions. These resolutions are Executive (600), Letter (300), and Draft (150), which represent the horizontal density. Additionally, there are two Light Mode settings (ON and OFF), which represent the vertical density. When Light Mode is "ON", the vertical density setting is 300 DPI; when Light Mode is "OFF" the vertical density setting is 600 DPI. Refer to the table below for the print mode options.

Print Quality:	With Light Mode set to "ON":	With Light Mode set to "OFF":
Executive	600 x 300 DPI	600 x 600 DPI
Letter	300 x 300 DPI	300 x 600 DPI
Draft	150 x 300 DPI	150 x 600 DPI

Fonts

Resident Fonts

Arial, Comic Sans MS, Courier New, Georgia, Impact, Kino, MSLogo, Symbol, Tahoma, Times New Roman, Trebuchet MS, Verdana, Webdings, Wingding, an OCR-A font and a Code 39 font. All fonts are scalable from 4 to 144 point size.

Resident Font Enhancements

Bold, Italic

Downloadable Fonts

Supports bitmapped, downloadable fonts.

Cartridge Fonts

Not Required. Fonts are downloaded with addresses.

User-Definable Parameters

- Font Characteristics
- Address Placement
- Barcode Characteristics
- Print Quality

Appendix A • Specifications

Barcode Printing Position

The printer can print a barcode in one of three positions:

- lower right of the envelope
- above the address block
- below the address block.

Barcode Printing Types

The printer can print the following barcodes:

1-Dimensional

- The printer is capable of printing a USPS Certified POSTNET barcode. All types of barcodes can be printable including FIM, 3 of 9, 4 state bar code (UK, Canadian, Euro, Australia, etc.) and others.
- The printer is capable of printing 5-, 9-, or 11- digit POSTNET barcodes. 5-digit barcode printing may be disabled through menu selection.
- Delivery point barcode is generated by transmitting the three digits.
- The printer is capable of printing planet barcode used for delivery confirmation services. The printer is also capable of printing any barcode rendered by a Windows® true type font.

2-Dimensional

The printer is capable of printing an USPS Certified IBIP barcode as well as all types of 2-D barcodes defined for the countries (UK, Canadian, Euro, Australia etc.) and others to the defined standards. Reference applicable Postal Standards.

Special Note on FIM Barcode (U.S. Only)

FIM (Face Identification Marking) barcode was developed by the USPS as part of their POSTNET barcoding system. It is normally used by high-volume mailers to put on return envelopes for their customers' invoices.

When the invoices are mailed back in their return envelope, the USPS sorts and processes this mail according to what version of FIM barcode is used on the envelope: FIM A (Postage required, POSTNET bar code included), FIM C (Postage prepaid, POSTNET bar code included), and FIM D (Postage required, POSTNET bar code not included).

One of the requirements of the FIM barcode is that it needs to be printed on the edge of the envelope (typically printed in the top right corner). This is difficult to support by our printers, especially on the trail edge. Inverted mode may supply a better print for the FIM, but any attempt to print to the exact edge of the envelope is liable to "miss" the edge occasionally. **Because of these issues, we cannot guarantee full USPS compliance.**

Throughput

14,000 letters per hour (lph)

Based on:

- Print quality - Draft mode
- 3-line destination address
- 18 characters per line
- 12-point character size
- Time New Roman font
- Bidirectional printing of text

NOTE: Adding graphics and/or printing at a higher resolution (e.g., Letter or Executive mode) will decrease throughput.

Stacker Capacity

- Input Stacker: 600 #10 or DL Envelopes with Bin extension, or 250 without extension installed.
- Output Stacker: 150 #10 or DL Envelopes

Appendix A • Specifications

Effective Print Area

The printable width is 9.4" (24cm) measured from the right side of the piece of mail. The printable height is 15" (38cm) measured from the bottom edge of the piece of mail. See the figure below.

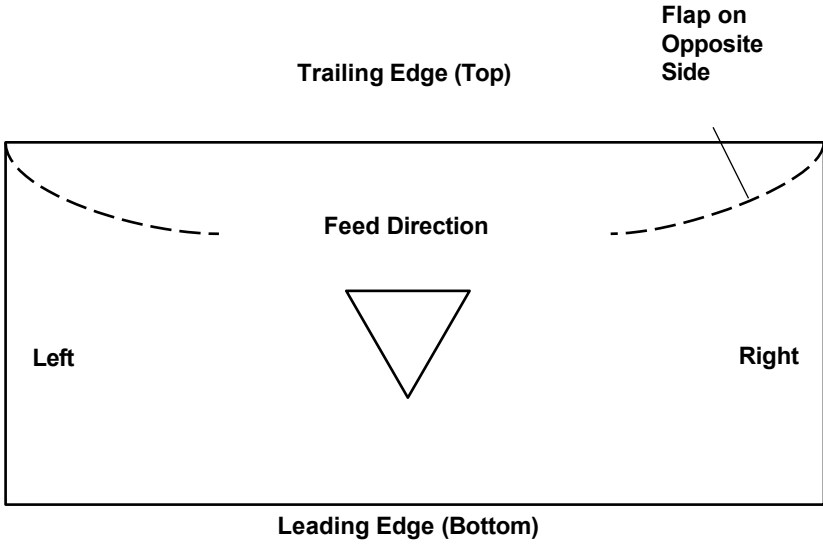

NOTES:

- All edges are viewed from the front surface of the material.
 - Two clear zones, each 0.3" (7.6mm) wide, are required on the piece of mail to allow clearance for the exit rollers.
 - Printing is allowed to the top edge of the media, however print quality will be degraded.
 - The lower 5/8" (16mm) of the material is reserved for the lower right barcode when it is used.
-

Printhead/InkJet Cartridges - U.S. Only

Cartridges: User-replaceable ink jet

Single Black Ink Cartridge: Order Number 660-1

Single Color Ink Cartridge: Order Number 660-5 (DA75S only)

4 Pack-Black Ink Cartridge: Order Number 660-9

Print Position Accuracy

For a #10 or DL envelope (Acclaim #10 WW Commercial, Regular):

- Horizontal: within +/- 1.5 mm
- Vertical: within +/- 1.5 mm
- Skew: within +/- 1 degree

For other media:

- Horizontal: within +/- 3.0 mm
- Vertical: within +/- 3.0 mm
- Skew: within +/- 2-1/2 degrees

Environmental Limits

Operating Conditions

- Temperature: 55 to 95°F (12 to 35°C)
- Humidity: 8 to 80%
- Maximum Wet Bulb Temperature: 80°F (27°C)

Storage Conditions

- Temperature (Printer): 15 to 120°F (-23.6 to 35.2°C)
- Humidity (Supplies): 5 to 95%
- Maximum Wet Bulb Temperature: 85°F (29°C)

Shipment Conditions

- Temperature (Printer): -40 to 140°F
- Humidity (Supplies): 5 to 100%
- Maximum Wet Bulb Temperature: 85°F (29°C)

Appendix A • Specifications

Noise Level

The sound pressure level at the operator's position for this equipment as measured in any mode using ANSI and ISO Standards is less than 72 dB(A).

Recommended Usage

This machine has been tested under many different conditions. We recommend that you do not exceed the usage levels specified below:

- Monthly usage is 250,000 pieces (86,000 pieces per month typical)

NOTE: Usage beyond these recommended cycles is not covered under your Equipment Maintenance Agreement.

- Product life is 5 years or 15,000,000 cycles

Material Specifications

Approved Media

The paper types listed below are approved for use with the printer. Please note that the dimensional limits above apply in all cases, and that all media (flats, envelopes, postcards, catalog envelopes, etc.) must be without windows, unstuffed and unsealed.

- White Wove
- Bond paper
- Recycled paper
- Coated paper
- Card stock
- Brown kraft
- Manila

Material Notes

- *Envelopes* have a flap along the long edge and are processed by the printer non-flap edge first. Envelopes may have either a diagonal or straight edge along the envelope flap.
- *Booklets* are defined as media having physical dimensions 6 x 9" (15.25 x 23cm) or larger. Booklets have an opening along their long edge which is covered by a flap with an adhesive seal.
- *Catalog envelopes* have an opening along their short edge which is closed by a flap with an adhesive seal.
- *Postcards* have no folds or bends. The printable side may have a higher surface roughness than the non-printable side.
- *Self-mailers* may be of "C," "Z," or half-folded construction. They may not exceed the maximum allowable thickness as specified on the previous page and must be tabbed per postal regulations.
- A *catalog* may consist of multiple pages bound by adhesive or tabs on the feed edge or at 90 degrees with respect to the feed edge.
- *Sheet stock* may consist of 16 to 28 lb. (60 to 105g/m²) bond as well as 60 to 80 lb. (220 to 300g/m²) coated stock. The size and thickness constraints specified above apply.

Appendix A • Specifications

Envelope Sizes

Paper Name	Displayed in List	Size (Width)	Size (Height)
US/Canada Envelope/Paper Sizes			
ENV_9	Envelope #9	8 ⁷ / ₈ "	3 ⁷ / ₈ "
ENV_10	Envelope #10	9 ¹ / ₂ "	4 ¹ / ₈ "
ENV_11	Envelope #11	10 ³ / ₈ "	4 ¹ / ₂ "
ENV_12	Envelope #12	11"	4 ³ / ₄ "
PPR_Booklet_9_12	Booklet 9 x 12	12"	9"
ENV_MONARCH	Envelope Monarch	7 ¹ / ₂ "	3 ⁷ / ₈ "
PPR_Card_4_6	Card 6 x 4	6"	4"
PPR_Card_5_7	Card 7 x 5	7"	5"
LETTER	Letter	8 ¹ / ₂ "	11"
LEGAL	Legal	8 ¹ / ₂ "	14"
EXECUTIVE	Executive	7 ¹ / ₄ "	10 ¹ / ₂ in
European Envelope/Paper Sizes			
ENV_B4	Envelope B4	353mm	250mm
ENV_B5	Envelope B5	250mm	176mm
ENV_B6	Envelope B6	176mm	125mm
ENV_C4	Envelope C4	324mm	229mm
ENV_C5	Envelope C5	229mm	162mm
ENV_C6	Envelope C6	162mm	114mm
ENV_C65	Envelope C65	229mm	114mm
PG_ENV_C76	Envelope C76	162mm	81mm
PG_ENV_C7	Envelope C7	114mm	81mm
ENV_DL	Envelope DL	220mm	110mm
ENV_DLX	Envelope DLX	235mm	120mm
ENV_DLE	Envelope DLE	225mm	114mm
A4	A4	210mm	297mm
A5	A5	148mm	210mm

Specifications • Appendix A

Paper Name	Displayed in List	Size (Width)	Size (Height)
<i>Asian Envelope/Paper Sizes</i>			
	Envelope 12JE	140mm	265mm
	Envelope 9JE	190mm	265mm
	Envelope 6JE	215mm	305mm
	Envelope ZL [China]	230mm	120mm
	Chou #3 Yoko	120mm	235mm
	Chou #4 Tate	90mm	205mm
	Hagaki	100mm	148mm
	Postcard #3	165mm	102mm
	Postcard #4	183mm	100mm
<i>Maximum Paper Size</i>		9.4"	15"

Appendix A • Specifications

This page is intentionally blank.

Appendix B • Glossary



This Appendix contains a glossary of terms related to your Address Printer and Computer.

Appendix B • Glossary

Cable

Wires that carry the information between the computer and the printer.

Character

A printable letter or symbol.

Character height

The height of a uppercase letter. A character height is measured in points.

Characters per inch

The number of characters printed in a horizontal inch. Also called pitch.

Character set

The set of characters or symbols that make up a language.

Clean print cartridge

Describes the process of removing dried ink from the nozzles of the ink jet cartridge.

Configuration

The settings used by the printer to communicate with the computer. Also the internal settings in the printer that control the print job.

Control code

The instructions sent to the printer to describe how to perform the print job.

Control panel

The buttons and display that are used to manually change the printer's settings.

CPI

See characters per inch.

Data communications

The sending of data from the computer to a peripheral device, i.e., the printer.

Dots per inch

The number of ink dots printed in one horizontal inch. The larger the number the better the resolution of print.

Double feeding

A condition in which two or more pieces of media feed at the same time or without separation.

DPI

See dots per inch.

Draft quality

A lower print resolution which saves ink and allows faster printing of a document.

Drivers

A file used by the computer's software to communicate commands and information that the printer needs to layout and print a document.

Embedded printer commands

Commands sent in a record or document to instruct the printer to change printing options.

Escape character

A special non-printable character used to instruct the printer to change printing options.

Escape sequence

Commands sent beginning with the escape character that instruct the printer to change printing options: fonts, page orientation, etc.

Feed gap

Adjustable opening between the ends of the H-Block Assembly fingers and the Feed Rollers so the media is fed one at a time.

Font

A set of printable characters with consistent style and characteristics.

Grounded

A electrical circuit that has a voltage of zero.

Handshaking

A method for the computer to communicate with peripheral devices to ensure complete transfer of information.

Appendix B • Glossary

Hex dump

A printer option that allows all the information and commands sent to the printer as base 16 digits.

Internal test address message

The preprogrammed Address that is printed when the Test button is pressed.

Interface cable

The cable that connects the printer or other device to the computer.

Interface connector

The connectors on both ends of the interface cable that insert into the interface ports.

Internal fonts

Resident or built-in fonts supplied with a printer.

Jam

See Paper Jam.

Letter quality

Print resolution which saves ink and still provides a high quality document.

Lines per inch

The number of lines printed in one vertical inch.

Menu directories

The list of available printer controls that appear on the bottom of the LCD display. A directory can contain other directories called "sub-directories."

Off Line

A condition in which the printer will not respond to information sent from the computer.

On line

A condition in which the printer will accept and respond to information sent from the computer.

Outline fonts

Scaleable printer fonts.

Paper jam

A condition in which media is stuck in the printer.

Parity

An error checking method used when communicating between the computer and a peripheral device.

PCL commands

A standard printer language of commands to access printer features or options.

Point size

A measurement standard for the height of a printed character. One point equals one seventy-second of an inch.

Postal regulations

Rules and guidelines set up by the Postal Authority for mail.

Power socket

The socket on the back of the printer where the line cord is connected.

Print cartridge

A removable container that holds ink for printing.

Print quality

Refers to the resolution or level of sharpness of the printed image.

Printer driver

See Drivers.

Record

A collection of related fields that make up the name and address of an individual in a mailing list file.

Sans serif

A font typeface that contains no serifs or finishing strokes on the top or bottom of the characters. Helvetica and Arial are examples of sans serif typefaces.

Scaleable fonts

Outline printer fonts that are stored in a mathematical form and can be enlarged or reduced.

Spacing

The relative spacing between characters.

Appendix B • Glossary

Stuffed media

Media that is already filled and sealed for delivery.

Subdirectory

A directory within a directory (or a folder within a folder).

Troubleshooting

The process of isolating and correcting a problem.

Universal Serial Bus (USB)

A communications protocol for connecting printers and other peripheral devices to a computer. This protocol supports automatic device detection for "plug and play" installation. It also it supports daisy chaining and branching for hot plug-and-play capability without disturbing running applications. USB also supports the SBP (serial bus protocol) which allows data transfers to PC peripherals. SBP allows bigger files to be sent asynchronously across the bus.

There are several USB standards, the latest of which, 2.0, supports communications up to 480 mb/sec.

The maximum recommended distance of a peripheral to a PC is 16 feet or 5 meters.

Index



Index

A

- Addresses "Walking" 4-3
 - Address High 4-5
 - Address Recovery Specification A-2
- Address Smudging 4-3
- Agency Approvals A-2
- Approved Media A-9
- Approved Media Types 2-2

B

- Barcode (Lower Right) is not Printing 4-5
- Bold Type
 - Unwanted 4-3

C

- Cartridge Fonts A-3
- Cleaning
 - Rubber Rollers 3-2
- Cleaning Printhead
 - Cartridge 3-2
- Contact Information iii
- Control Language A-2
- Control Panel 1-7

D

- Downloadable Fonts A-3

E

- Effective Print Area A-5
- Electrical
 - Specifications A-2
- Envelope Sizes A-10
- Environmental Limits A-8
- Ethernet Cable 1-2
- Exit Rollers 2-12

F

- Side Guide 2-9
- Feed Gap, setting 2-4
- Feed Ramp 1-7,2-8
- Font Size 2-2
- Fuzzy Printing 4-3

G

- Getting Help 1-3
- Glossary B-2,B-3,B-4,B-5,B-6
- Glossy Material
 - Print Quality 2-11

H

- Heavy Material 2-6

I

- Ink Jet Cartridge
 - Installing 3-5
 - Removing 3-6
- Input Guide 1-7
- Input Guide Slide 1-7
- Installing
 - Ink Jet Cartridge 3-5
- Interface
 - USB, Ethernet A-2
- Internal Fonts 2-2

J

- Jam
 - Paper 4-6
 - Shuttle 4-6

L

Light Print 4-3

M

Material Notes A-9
Material Safety Data Sheets
 iii
Media Size 2-2
Media Thickness Knob 1-7,2-
 11,3-2
Memory Card Error 4-6

N

Noise Level A-8
No Print 4-3

O

Operating System
 Recommended 1-2
Ordering Supplies iii
Out of Memory 4-6

P

Paper Jam 4-6
Petroleum Based Cleaning
 Solvents 3-2
Print
 No printing 4-3
Printhead
 Purging 3-2
Printing
 Light 4-3
 Not Sharp 4-3
 Test Piece 2-13
Print Modes (Print Resolution)
 Available A-3

Print Position Accuracy A-7
Print Qualities 2-2
Purging Printhead 3-2,3-4

R

Recommended Usage A-8
Recycled Material
 Print Quality 2-11
Resident Font
 Enhancements A-3
Resident Fonts
 Listing A-3

S

Separator Gap 2-3
Setup Adjustments
 Exit Rollers 2-12
 Feed Fence 2-9
 Media Thickness Lever
 2-11
 Output Stack Height 2-12
 Separator Gap 2-3
Shingling
 Stack 2-10
Shuttle Jam 4-6
Side Guide 1-7
Skew
 Avoiding 2-9
Smudging
 Address 4-3
Specifications
 Address Recovery A-2
 Agency Approvals A-2
 Approved Media A-9
 Cartridge Fonts A-3
 Control Language A-2
 Downloadable Fonts A-3
 Effective Print Area A-5
 Electrical A-2
 Environmental Limits A-8

Index

Fonts A-3
Interface A-2
Material Notes A-9
Noise Level A-8
Printhead/InkJet Cartridge
 A-8
Print Modes (Print
 Resolution) A-3
Print Position Accuracy
 A-7
Recommended Usage
 A-8
Resident Font
 Enhancements A-3
Resident Fonts A-3
Stacker Capacity A-5
Weight A-2
Speed
 Printer 2-2
Stacker Capacity A-5

T

Technical Support iii
Test Piece 2-13
Troubleshooting
 Address Printing is not
 Sharp 4-3
 Address Smudging 4-3
 Address too High 4-5
 Barcode (Lower Right) is
 not Printing 4-5
 Intermittent Feed 4-2
 Memory Card Error 4-6
 No Print 4-3
 Out of Memory 4-6
 Shuttle Jam 4-6
 Unwanted Bolding 4-3
Tyvek
 Print Quality 2-11

U

Unwanted Bolding 4-3
USB Port
 Cable Length 1-2

W

Weight A-2



Pitney Bowes Limited
3001 Summer Street, Stamford
Connecticut 06926
www.pitneybowes.com

For Service or Supplies

PB Form SV61665 Rev. E 2/24

©2024 Pitney Bowes Inc.
All Rights Reserved
Printed in the USA or Canada

 Printed on recyclable paper

